



Food and Agriculture  
Organization of the  
United Nations



iotc

---

# Procedures for the implementation of the Indian Ocean Tuna Commission Port State measures

---

2021

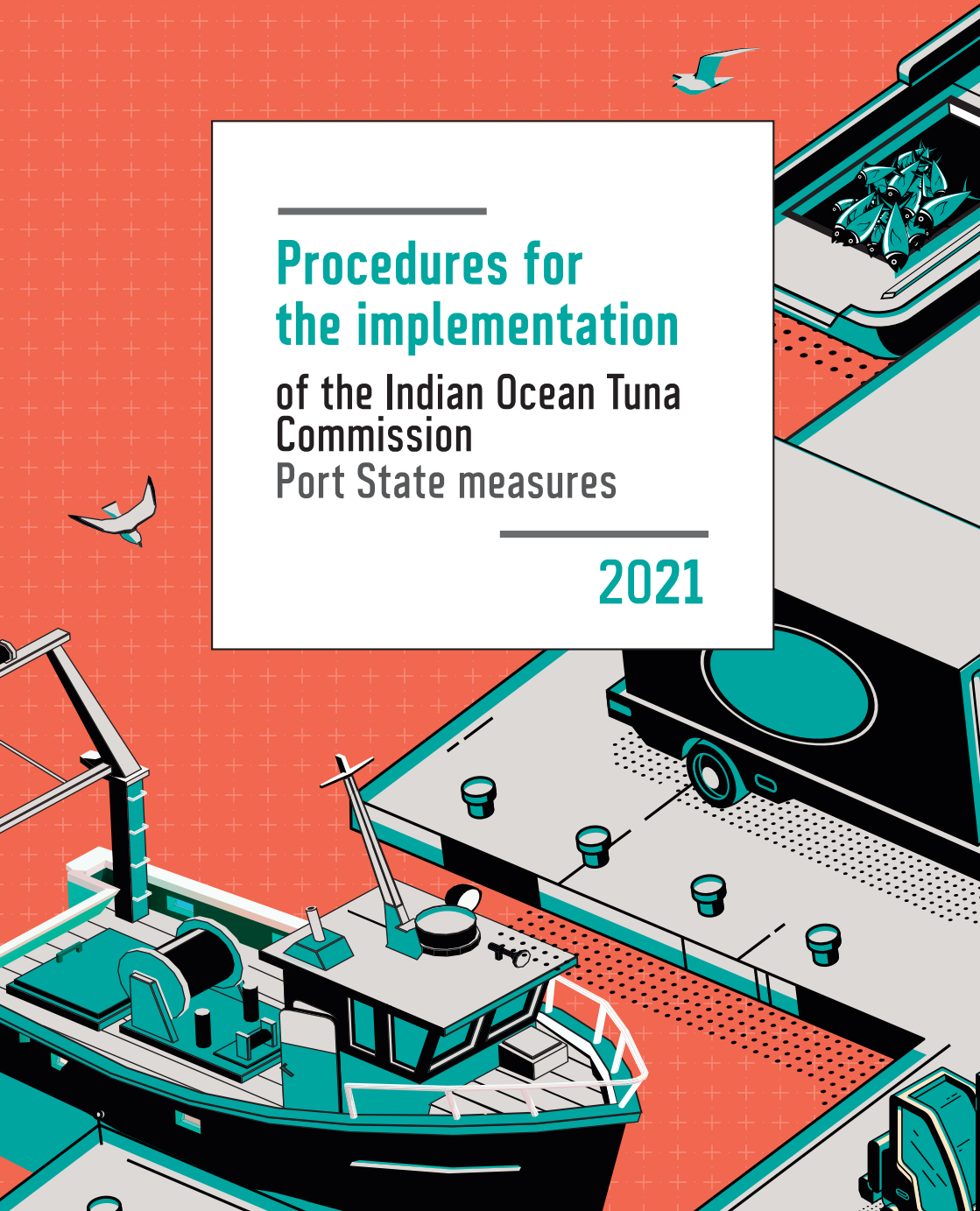



**Procedures for  
the implementation  
of the Indian Ocean Tuna  
Commission  
Port State measures**

---

**2021**

IOTC. 2021. *Procedures for the implementation of the Indian Ocean Tuna Commission Port State Measures*. Victoria, Seychelles, FAO.  
<https://doi.org/10.4060/cb7113en>

The designations employed and the presentation of material in this information product do not imply the expression of any opinion whatsoever on the part of the Food and Agriculture Organization of the United Nations (FAO) concerning the legal or development status of any country, territory, city or area or of its authorities, or concerning the delimitation of its frontiers or boundaries. The mention of specific companies or products of manufacturers, whether or not these have been patented, does not imply that these have been endorsed or recommended by FAO in preference to others of a similar nature that are not mentioned.

The views expressed in this information product are those of the author(s) and do not necessarily reflect the views or policies of FAO.

ISBN 978-92-5-135091-1 [FAO]

© FAO, 2021



Some rights reserved. This work is made available under the Creative Commons Attribution-NonCommercial-ShareAlike 3.0 IGO licence (CC BY-NC-SA 3.0 IGO; <https://creativecommons.org/licenses/by-nc-sa/3.0/igo/legalcode>).

Under the terms of this licence, this work may be copied, redistributed and adapted for non-commercial purposes, provided that the work is appropriately cited. In any use of this work, there should be no suggestion that FAO endorses any specific organization, products or services. The use of the FAO logo is not permitted. If the work is adapted, then it must be licensed under the same or equivalent Creative Commons licence. If a translation of this work is created, it must include the following disclaimer along with the required citation: "This translation was not created by the Food and Agriculture Organization of the United Nations (FAO). FAO is not responsible for the content or accuracy of this translation. The original [Language] edition shall be the authoritative edition."

Disputes arising under the licence that cannot be settled amicably will be resolved by mediation and arbitration as described in Article 8 of the licence except as otherwise provided herein. The applicable mediation rules will be the mediation rules of the World Intellectual Property Organization <http://www.wipo.int/amc/en/mediation/rules> and any arbitration will be conducted in accordance with the Arbitration Rules of the United Nations Commission on International Trade Law (UNCITRAL).

**Third-party materials.** Users wishing to reuse material from this work that is attributed to a third party, such as tables, figures or images, are responsible for determining whether permission is needed for that reuse and for obtaining permission from the copyright holder. The risk of claims resulting from infringement of any third-party-owned component in the work rests solely with the user.

**Sales, rights and licensing.** FAO information products are available on the FAO website ([www.fao.org/publications](http://www.fao.org/publications)) and can be purchased through [publications-sales@fao.org](mailto:publications-sales@fao.org). Requests for commercial use should be submitted via: [www.fao.org/contact-us/licence-request](http://www.fao.org/contact-us/licence-request). Queries regarding rights and licensing should be submitted to: [copyright@fao.org](mailto:copyright@fao.org).

Graphic Design: Sabine Billon

## Abstract

The objective of this manual is to provide a working document for port State authorities to use in the implementation of the IOTC Port State Measures Resolution (PSMR), which entered into force on 1 March 2011 and was amended in 2016 to include a provision on the electronic port State measures application (e-PSM).

The content is divided into three chapters.

The first chapter describes the functions and operations of IOTC and the Indian Ocean tuna fishery, and summarises the development of port State measures by the international community and the development by IOTC Contracting Parties and Cooperating Non-Contracting Parties (CPCs) of conservation and management measures that both reflect and complement the internationally agreed measures.

The second chapter addresses operational and technical matters, key elements for the training of managers and inspectors, to provide them with the knowledge to implement the port State measures practically and effectively.

The third chapter provides guides to and checklists for standard operating procedures to implement the measures for vessels from the main fishing sectors likely to be encountered in the Indian Ocean region.

This manual should be viewed as a living document that can be revised and improved by all parties as experience is expanded in the implementation of the IOTC PSMR.



# Contents

<b>Abstract</b>	<b>iii</b>
<b>Foreword</b>	<b>xxv</b>
<b>Acknowledgements</b>	<b>xxvi</b>
<b>Abbreviations and acronyms</b>	<b>xxvii</b>
<b>Terms</b>	<b>xxix</b>
<b>Introduction</b>	<b>1</b>
<b>CHAPTER 1 : BACKGROUND</b>	<b>3</b>
<b>1 - IOTC organisation and role</b>	<b>5</b>
1.1 Members	9
1.2 The Commission	11
1.2.1 Functions and responsibilities	11
1.2.2 Decision-making and Members' implementation responsibilities	12
1.3 Organisational structure	13
1.3.1 Secretariat	14
1.3.2 Committees	18
<b>2 - Overview of the Indian Ocean tuna fishery</b>	<b>21</b>
2.1. The tuna resources	23
2.2. Ports supporting the Indian Ocean tuna fishery	26
2.2.1. The flow of tuna catches: in port versus at-sea transshipment	26
2.2.2. Activities in ports	27
2.3. Purse seine fishery	29
2.4. The longline fishery	32

<b>3 - Background to the development of port State measures</b>	<b>37</b>
3.1. Background on the development of the FAO Agreement on Port State Measures	39
3.2. Review of IOTC Resolutions on MCS relevant to Port State Measures	50
3.3. The IOTC Port State Measures Resolution	53
<b>CHAPTER 2 : OPERATIONAL AND TECHNICAL INFORMATION</b>	<b>71</b>
<b>4 - Inspector appointment and training</b>	<b>73</b>
4.1. Ethics and confidentiality of information	76
4.1.1. Professional conduct	76
4.1.2. Uniforms and appearance	79
4.1.3. Confidentiality of information	80
4.2. Health and safety on board	80
4.2.1. Protective clothing	82
4.2.2. Safe working practices	84
4.2.3. Procedure for entering enclosed spaces	85
4.3. Fish and product identification	86
4.3.1. On board fish processing and preservation	90
4.3.2. Conversion factors	95
4.4. Fishing gear design and specifications	99
4.4.1. Primary fishing gear used in the Indian Ocean region	99
4.4.2. Pelagic longline	101
4.4.3. Industrial tuna purse seine	102
4.4.4. Pole and line	104
4.4.5. Gillnet	105
4.4.6. Vessels with alternative gear	106



4.5. Navigation equipment	113
4.6. Vessel Monitoring Systems	118
4.6.1. VMS functions and types	119
4.6.2. VMS identification guide	126
4.6.3. Means used by vessel to tamper with or falsify VMS data to prevent detection of IUU fishing activities	144
4.6.4. On board inspection of the VMS	147
4.7. Powers of fisheries inspectors	149
4.7.1. Collection of evidence and follow-up actions	150
4.7.2. Interviewing, recording and witness statements	155
<b>CHAPTER 3 : PROCEDURES</b>	<b>159</b>
<b>5 - Advance Request to Enter Port</b>	<b>161</b>
5.1. Assessment of vessel request to enter port	164
5.2. Risk assessment process	168
5.3. Procedures to assess the AREP	176
5.4. Risk Assessment Report and guide to completing the "Check list - Assessment of the AREP" form	191
5.5. Inspection briefing	199
<b>6 - Standard Operating Procedures - on board inspection of vessel</b>	<b>201</b>
6.1. Pre-boarding process	204
6.1.1. Selection of fishing vessel and risk assessment	204
6.1.2. Preparation for boarding	208
6.2. On board inspection - Standard Operating Procedures	212
6.2.1. Requirement of the port State inspection	212
6.2.2. Port State inspection - Standard Operating Procedures	214

<b>6.3. Monitoring landing and transhipments in port</b>	<b>251</b>
6.3.1. Preparation and planning offloading operations	253
6.3.2. Landing from tuna longline vessels to shore or transhipping to a carrier vessel	261
6.3.3. Offloading from purse seine vessels	273
6.3.4. Offloading from carrier vessels	282
6.3.5. Sampling forms	290
<b>6.4. Follow up procedures, actions and requirements, and information sharing</b>	<b>291</b>
6.4.1. Reporting the results of inspections	291
6.4.2. Port State actions following inspections	293
6.4.3. Flag State role and responsibilities	310
6.4.4. Duties of the IOTC Secretariat	311
<b>6.5. Information systems on port State measures</b>	<b>311</b>

## **7 - Appendices**

**313**

<b>Appendix I: IOTC Resolution 16/11 on Port State Measures to Prevent, Deter and Eliminate Illegal, Unreported and Unregulated Fishing</b>	<b>315</b>
<b>Appendix II: Fishing gear design and specifications that can be encountered in the Indian Ocean region</b>	<b>329</b>
<b>Appendix III: Navigation, latitude and longitude</b>	<b>353</b>
<b>Appendix IV Forms</b>	<b>359</b>
<b>Appendix V: Data field descriptions and guide to complete the Advance Request for Entry into port (Annex 1 of IOTC PSMR 16/11)</b>	<b>362</b>
<b>Appendix VI: Check List - Assessment of the Advance Request for Entry into Port</b>	<b>370</b>
<b>Appendix VII: Notification to fishing vessel following an Advance Request for Entry into Port</b>	<b>373</b>
<b>Appendix VIII: Request for additional information (following AREP)</b>	<b>375</b>
<b>Appendix IX: Port inspection report form (IOTC PSMR Annex III) and guide for completion</b>	<b>380</b>
<b>Appendix X: Port inspection report form for IOTC CMM requirements</b>	<b>391</b>

<b>Appendix XI: Offloading Monitoring Form and guide for completion</b>	396
<b>Appendix XII: Request for additional information [following a port inspection]</b>	406
<b>Appendix XIII: Codes for countries, fishing gears, fishing vessels and IOTC species</b>	408

# Figures

---

<b>Figure 1:</b> Transshipment of tunas	<b>1</b>
---	----------

---

<b>Figure 2:</b> IOTC carrier vessels	<b>2</b>
---------------------------------------	----------

---

<b>Figure 3:</b> Area of competence of the Indian Ocean Tuna Commission	<b>7</b>
---	----------

---

<b>Figure 4:</b> Five major tuna RFMOs covering the oceanic regions	<b>8</b>
---	----------

---

<b>Figure 5:</b> Resolutions of the IOTC	<b>12</b>
--	-----------

---

<b>Figure 6:</b> Recommendations of the IOTC	<b>13</b>
--	-----------

---

<b>Figure 7:</b> Organigramme of the IOTC organisational structure	<b>14</b>
--	-----------

---

<b>Figure 8:</b> Core functions of the IOTC Secretariat	<b>15</b>
---	-----------

---

<b>Figure 9:</b> Organisational structure of the IOTC Secretariat	<b>18</b>
---	-----------

---

<b>Figure 10:</b> Commission meeting of the IOTC	<b>20</b>
--	-----------

---

<b>Figure 11:</b> Total catches (thousands of metric tons) of major IOTC species (YFT: yellowfin tuna, BET: bigeye tuna, SKJ: skipjack tuna, ALB: albacore, SWO: swordfish), and other species	<b>23</b>
--	-----------

---

<b>Figure 12:</b> Total catches (thousands of metric tons) of IOTC species, by type of gear and year (1950-2018)	<b>25</b>
--	-----------

---

<b>Figure 13:</b> Amount of catch unloaded by foreign vessels in ports within the territory of IOTC coastal States and catches transhipped on the high seas by longline vessels under the IOTC Transshipment Programme, (2009), by type of gear	<b>28</b>
---	-----------

<b>Figure 14:</b> Indian Ocean region ports predominantly used for off-loading and port services (Annual number of vessels calling into ports in the Indian Ocean region, source IOTC e-PSM 2020)	<b>29</b>
<b>Figure 15:</b> Catches of major IOTC species (Tropical tunas, albacore and swordfish) by industrial fleets in the Indian Ocean by type of gear (LL: Longline, BB: Baitboat, PSFS: purse seine free-schools, PSLs: purse seine associated schools) and 5 degrees square area for the period 2000-2018 (Excludes gillnet fisheries)	<b>31</b>
<b>Figure 16:</b> Catches of major IOTC species (YFT: yellowfin tuna, BET: bigeye tuna, SKJ: skipjack tuna, ALB: albacore, SWO: swordfish) by industrial fleets in the Indian Ocean by species and 5 degrees square area for the period 2000-2018 (Excludes gillnet fisheries)	<b>32</b>
<b>Figure 17:</b> Quarterly average catches by longliners during the period 1994-2018 by season	<b>36</b>
<b>Figure 18:</b> The 1993 FAO Compliance Agreement	<b>40</b>
<b>Figure 19:</b> 1995 UN Fish Stocks Agreement	<b>41</b>
<b>Figure 20:</b> 2001 FAO IPOA to Prevent, Deter and Eliminate IUU Fishing	<b>43</b>
<b>Figure 21:</b> Model Scheme on Port State Measures (2005)	<b>45</b>
<b>Figure 22:</b> 2009 FAO Port State Measures Agreement to Prevent, Deter and Eliminate IUU Fishing	<b>47</b>
<b>Figure 23:</b> Fisheries inspector completing the port inspection report on board a vessel	<b>79</b>
<b>Figure 24:</b> Wearing hard hat is mandatory during offloading operation	<b>80</b>

<b>Figure 25:</b> Important protective clothes for the conduct of inspection in port	<b>82</b>
<b>Figure 26:</b> Brailing operations on a purse seiner	<b>84</b>
<b>Figure 27:</b> Tunas are being conveyed to the wells located at the lower deck of a purse seiner	<b>84</b>
<b>Figure 28:</b> Inspection of a well on board a longliner	<b>85</b>
<b>Figure 29:</b> Yellowfin tuna and bigeye tuna in fresh condition	<b>89</b>
<b>Figure 30:</b> Identification features of the four main tunas species caught by purse seine, pole and line and longline vessels	<b>90</b>
<b>Figure 31:</b> The primary fishing gears used in IOTC fisheries: Purse Seine (PS), Pole and line (PoL), drifting longline (LL) and Gillnet (GN)	<b>100</b>
<b>Figure 32:</b> FAD buoys stored on upper deck of a purse seiner	<b>100</b>
<b>Figure 33:</b> Setting of a drifting FAD by a purse seiner	<b>100</b>
<b>Figure 34:</b> Main components of a drifting longline	<b>102</b>
<b>Figure 35:</b> Oceanic tuna seiner in fishing operation in the Indian Ocean	<b>103</b>
<b>Figure 36:</b> Pole and line fishing vessel in fishing operation in the Indian Ocean	<b>104</b>
<b>Figure 37:</b> Driftnet of more than 25 km on board a tuna driftnetter operating in the Indian Ocean	<b>105</b>
<b>Figure 38:</b> Roller / guide used on tuna gillnet vessels	<b>105</b>

---

<b>Figure 39:</b> Some navigation & communication systems	<b>113</b>
---	------------

---

<b>Figure 40:</b> Electronic navigation and communication systems on board purse seiner	<b>114</b>
---	------------

---

<b>Figure 41:</b> Communication equipment and computerised satellite systems on board a carrier vessel	<b>117</b>
--	------------

---

<b>Figure 42:</b> Argos satellites constellation and coverage	<b>121</b>
---	------------

---

<b>Figure 43:</b> Inmarsat satellites constellation and coverage	<b>123</b>
--	------------

---

<b>Figure 44:</b> Iridium satellites constellation and coverage	<b>124</b>
---	------------

---

<b>Figure 45:</b> Orbcomm satellites constellation and coverage	<b>125</b>
---	------------

---

<b>Figure 46:</b> Thrane & Thrane (Sailor) Capsat TT-3022D unit and antenna	<b>127</b>
---	------------

---

<b>Figure 47:</b> Thrane & Thrane (Sailor) Capsat TT-3026S Mini C Unit and antenna	<b>128</b>
--	------------

---

<b>Figure 48:</b> Trimble galaxy unit and antenna	<b>129</b>
---	------------

---

<b>Figure 49:</b> MARGE unit and antenna	<b>130</b>
--	------------

---

<b>Figure 50:</b> Marge GE V2 unit and antenna	<b>131</b>
--	------------

---

<b>Figure 51:</b> Seimac unit and antenna	<b>132</b>
---	------------

---

<b>Figure 52:</b> LEO unit and antenna	<b>133</b>
--	------------

---

<b>Figure 53:</b> CLS VELA unit and antenna	<b>134</b>
---	------------

<b>Figure 54:</b> Thorium TST unit and antenna	<b>135</b>
<b>Figure 55:</b> Furuno Felcom unit and antenna	<b>136</b>
<b>Figure 56:</b> JRC JUE-95VM unit and antenna	<b>137</b>
<b>Figure 57:</b> Thrane & Thrane (Sailor) Capsat 6194 terminal unit and antenna	<b>138</b>
<b>Figure 58:</b> CLS triton (iridium) unit and antenna	<b>139</b>
<b>Figure 59:</b> Cobham/SAILOR 250 FLEET BROADBAND unit and antenna	<b>140</b>
<b>Figure 60:</b> Pole Star MAT - 1DP690 unit and antenna	<b>141</b>
<b>Figure 61:</b> BEAM Oceana 800 unit and antenna	<b>142</b>
<b>Figure 62:</b> Glocom GX-9unit and antenna	<b>143</b>
<b>Figure 63:</b> Two VMS units installed on board a tuna longliner (Thrane & Thrane 3022D INMARSAT and Junction box of the Trimble Galaxy unit)	<b>144</b>
<b>Figure 64:</b> Two VMS units installed on board a tuna longliner (Thrane & Thrane 3022D INMARSAT and Junction box for the Argos MARGE unit)	<b>144</b>
<b>Figure 65:</b> Tampering with the shipboard transponder equipment to falsify data transmitted	<b>145</b>
<b>Figure 66:</b> Argos junction box with on/off switch	<b>146</b>
<b>Figure 67:</b> Argos junction box switched off	<b>146</b>



<b>Figure 68:</b> Preserving evidences: main steps	151
<b>Figure 69:</b> Preserving evidences: collection of documents	154
<b>Figure 70:</b> Preserving evidences: photographs to be taken	155
<b>Figure 71:</b> Steps to preserve evidences	157
<b>Figure 72:</b> Steps to preserve evidence	158
<b>Figure 73:</b> The process underlying port State measures	163
<b>Figure 74:</b> Vessel advance request to enter port (AREP) and assessment and communication processes	166
<b>Figure 75:</b> Risk assessment process	174
<b>Figure 76:</b> Main target points of the inspection in port	175
<b>Figure 77:</b> Recommended sources of information	176
<b>Figure 78:</b> Sources of information for IMO number	180
<b>Figure 79:</b> Sources of information for fishing authorisations	183
<b>Figure 80:</b> Sources of transshipment information	187
<b>Figure 81:</b> Sources of transshipment information	189
<b>Figure 82:</b> Inspection tool kit	211
<b>Figure 83:</b> Confused marks on the stern of a longliner that need further investigation during the inspection	218

<b>Figure 84:</b> Argos junction box switched off	<b>224</b>
<b>Figure 85:</b> ATF produced by the master It is a web print of the IOTC record of authorised vessel of the inspected vessel	<b>227</b>
<b>Figure 86:</b> Inspection of the fish holds of a tuna longliner	<b>233</b>
<b>Figure 87:</b> Fishing logbook at the IOTC format	<b>237</b>
<b>Figure 88:</b> Fishing logbook in a calendar format not matching IOTC requirements	<b>237</b>
<b>Figure 89:</b> Long handled device (from top): J-Style de-hooker, line cutter and de-hooker for ingested hooks	<b>241</b>
<b>Figure 90:</b> Example of dip-net used to hoist the turtle on board	<b>241</b>
<b>Figure 91:</b> Hoisting of a turtle in a dip net on board a tuna longliner	<b>241</b>
<b>Figure 92:</b> Diagram of bird-scaring Streamer Line	<b>242</b>
<b>Figure 93:</b> Interaction with seabirds are more common below S 25 °	<b>243</b>
<b>Figure 94:</b> Shark fins drying on the upper deck of vessel	<b>244</b>
<b>Figure 95:</b> Shark fins in bags	<b>244</b>
<b>Figure 96:</b> Packed shark fins	<b>244</b>
<b>Figure 97:</b> Caudal fin of thresher shark found on board a tuna longliner	<b>245</b>
<b>Figure 98:</b> Thresher sharks caught by a tuna longliner	<b>245</b>

---

<b>Figure 99:</b> Oceanic whitetip shark caught by a tuna longliner	<b>246</b>
---	------------

---

<b>Figure 100:</b> Brailing operations on a purse seiner	<b>247</b>
--	------------

---

<b>Figure 101:</b> Mobulid rays are listed in Appendix I and Appendix II of the Convention on the Conservation of Migratory Species of Wild Animals (CMS) and are also listed in Appendix II of the Convention on International Trade in Endangered Species of Wild Fauna and Flora (CITES)	<b>248</b>
---	------------

---

<b>Figure 102:</b> Inspection in port outcomes	<b>250</b>
--	------------

---

<b>Figure 103:</b> Fish in a vessel hold and offloading operation	<b>253</b>
---	------------

---

<b>Figure 104:</b> Essential working documents to prepare the monitoring of offloading of the catch of a vessel	<b>255</b>
---	------------

---

<b>Figure 105:</b> Essential vessel working documents to check for the monitoring of offloading of the catch of a vessel	<b>256</b>
--	------------

---

<b>Figure 106:</b> Example of key positions to monitor offloading	<b>257</b>
---	------------

---

<b>Figure 107:</b> Direct offloading of tunas	<b>261</b>
---	------------

---

<b>Figure 108:</b> Small batches of frozen tunas	<b>262</b>
--	------------

---

<b>Figure 109:</b> Transshipment of tunas in a cargo net	<b>263</b>
--	------------

---

<b>Figure 110:</b> Direct offloading	<b>264</b>
--------------------------------------	------------

---

<b>Figure 111:</b> Fish being aggregated on the deck of small longline vessel and a combined hoist being transferred to a carrier vessel	<b>265</b>
--	------------

---

<b>Figure 112:</b> Weighting of tunas and striped marlins in port	<b>266</b>
---	------------

---

<b>Figure 113:</b> Hook scale	<b>267</b>
<b>Figure 114:</b> Photo series depicting an in-port transshipment of tunas	<b>268</b>
<b>Figure 115:</b> Inspection of a fish hold on a purse seiner	<b>273</b>
<b>Figure 116:</b> Monitoring tuna offloading on a purse seiner	<b>274</b>
<b>Figure 117:</b> Tuna on the conveyor belt of a purse seiner	<b>277</b>
<b>Figure 118:</b> Fish from different donor vessels separated in the fish hold of a carrier vessel	<b>283</b>
<b>Figure 119:</b> Essential documents to gather prior to monitor offloading	<b>284</b>
<b>Figure 120:</b> Example of carrier cargo plan	<b>285</b>
<b>Figure 121:</b> Offloading of string of tunas	<b>286</b>
<b>Figure 122:</b> Inspecting CPC reporting requirements following inspections	<b>292</b>
<b>Figure 123:</b> Reporting requirements following inspections	<b>292</b>
<b>Figure 124:</b> Reporting requirements following an inspection	<b>293</b>
<b>Figure 125:</b> Port State actions when evidence indicates IUU fishing or related activities	<b>298</b>

---

# Boxes

<b>Box 1</b>   Functions and responsibilities of the Commission	<b>11</b>
<b>Box 2</b>   IOTC Resolutions and Recommendations	<b>13</b>
<b>Box 3</b>   The working parties of the IOTC Scientific Committee	<b>19</b>
<b>Box 4</b>   Flow of tuna catches in the Indian Ocean (Source IOTC 2009)	<b>27</b>
<b>Box 5</b>   Background to the development of Port State Measures	<b>39</b>
<b>Box 6</b>   UN Fish Stocks Agreement and Port State Measures	<b>42</b>
<b>Box 7</b>   FAO IPOA-IUU and Port State Measures	<b>43</b>
<b>Box 8</b>   FAO Model Scheme on Port State Measures	<b>46</b>
<b>Box 9</b>   Outline of the structure of the FAO Port State Measures Agreement	<b>49</b>
<b>Box 10</b>   IOTC Resolutions that feature, complement or support port State measures	<b>52</b>
<b>Box 11</b>   IOTC Port State Measures Resolution	<b>53</b>
<b>Box 12</b>   Structure of the IOTC Port State Measures Resolution	<b>55</b>
<b>Box 13</b>   Role and responsibility of the port State - application to foreign vessels	<b>56</b>
<b>Box 14</b>   Role and responsibilities of the port State - fundamental requirements for implementing the IOTC PSMR	<b>63</b>

---

<b>Box 15   Role and responsibilities of the flag State - fundamental requirements for implementing the IOTC PSMR</b>	<b>65</b>
<b>Box 16   Role and responsibilities of the fishing industry</b>	<b>67</b>
<b>Box 17   Duties of the IOTC Secretariat</b>	<b>68</b>
<b>Box 18   Inspection of fishing vessels - Professional conduct</b>	<b>78</b>
<b>Box 19   Inspection of fishing vessels - Common risks on board vessels</b>	<b>81</b>
<b>Box 20   Determination of conversion factor of a yellow fin tuna</b>	<b>96</b>
<b>Box 21   Using conversion factor to calculate live weight</b>	<b>96</b>
<b>Box 22   Argos system</b>	<b>122</b>
<b>Box 23   Inmarsat system</b>	<b>123</b>
<b>Box 24   Iridium system</b>	<b>124</b>
<b>Box 25   Checklist for the inspection of VMS</b>	<b>148</b>
<b>Box 26   IOTC definition of IUU fishing activities (Resolution 18/03)</b>	<b>152</b>
<b>Box 27   An example of a preamble</b>	<b>155</b>
<b>Box 28   Port entry - Requirements and procedures</b>	<b>167</b>
<b>Box 29   Examples of criteria for identifying a vessel as high risk</b>	<b>169</b>
<b>Box 30   Examples of criteria for identifying a vessel as low risk</b>	<b>171</b>

---

<b>Box 31</b>   Requirement / procedure to be followed by the port State for a vessel denied port entry_____	<b>173</b>
<b>Box 32</b>   Example of change of name of fishing vessel_____	<b>180</b>
<b>Box 33</b>   Risk assessment outcomes_____	<b>205</b>
<b>Box 34</b>   Risk categories assigned to vessel_____	<b>207</b>
<b>Box 35</b>   Examples of contraventions of the IOTC PSMR violations following embarkation of inspectors on the vessel_____	<b>220</b>
<b>Box 36</b>   Examples of contraventions of IOTC Resolution 19/04 PSMR violations on vessel details and flag State registration_____	<b>222</b>
<b>Box 37</b>   Examples of contraventions of IOTC Resolution 15/03 violations on the vessel monitoring system_____	<b>225</b>
<b>Box 38</b>   Examples of contraventions of the IOTC requirements for registration on the RAVPSMR violations_____	<b>226</b>
<b>Box 39</b>   Examples of contraventions of the IOTC Resolution - Authorisation to fish_____	<b>227</b>
<b>Box 40</b>   Example of contravention of IOTC Resolutions on transshipment authorisation_____	<b>228</b>
<b>Box 41</b>   Example of contravention of the IOTC Resolution concerning donors vessels_____	<b>231</b>
<b>Box 42</b>   Example of possible contraventions of IOTC Resolutions on fishing logbook_____	<b>237</b>
<b>Box 43</b>   Examples of possible contravention of IOTC Resolution on fishing gear_____	<b>240</b>

---

<b>Box 44</b>   Example of contravention of IOTC Resolution on protected and endangered species	<b>248</b>
<b>Box 45</b>   Monitoring of landing and transshipment - preparation checklist	<b>254</b>
<b>Box 46</b>   Monitoring of landing or transshipment - using conversion factor	<b>269</b>
<b>Box 47</b>   Monitoring of landing and transshipment - calculation of total weight	<b>276</b>
<b>Box 48</b>   Determine species composition	<b>278</b>
<b>Box 49</b>   Calculation of unit trunk weight on a string using a hook scale	<b>287</b>

---



# Tables

<b>Table 1</b> - CPCs of the Indian Ocean Tuna Commission_____	<b>10</b>
<b>Table 2</b> - Principal fish species caught in the Indian Ocean region _____	<b>87</b>
<b>Table 3</b> - Comparative common names of the main species caught in the Indian Ocean region_____	<b>88</b>
<b>Table 4</b> - Types of on board fish processing codes used in IOTC_____	<b>91</b>
<b>Table 5</b> - Types of on-board fish processing codes used in IOTC_____	<b>92</b>
<b>Table 6</b> - Types of on board fish preservation used in IOTC _____	<b>95</b>
<b>Table 7</b> - Conversion factors and processing code for target species_____	<b>97</b>
<b>Table 8</b> - Conversion factors and processing code for shark species_____	<b>97</b>
<b>Table 9</b> - Conversion factors and processing code for bycatch species_____	<b>98</b>
<b>Table 10</b> - Summary checklist of fishing gear components that can be identified in the primary fishing sectors on larger commercial vessels_____	<b>107</b>
<b>Table 11</b> - Basic navigation and communication equipment likely to be found on the bridge of all vessels_____	<b>115</b>
<b>Table 12</b> - Contact details for IUU Vessel Lists_____	<b>177</b>
<b>Table 13</b> - The fields to be verified in the AREP_____	<b>178</b>
<b>Table 14</b> - Checks if not on IOTC Record of Authorised Vessels_____	<b>179</b>
<b>Table 15</b> - IMO number: target information & verification process_____	<b>181</b>
<b>Table 16</b> - IMO number: verification_____	<b>182</b>
<b>Table 17</b> - Fishing authorisations: target information & verification process_____	<b>184</b>
<b>Table 18</b> - Fishing authorisations: verification_____	<b>184</b>

<b>Table 19</b> - Fishing authorisation: verification in the case of suspicion	<b>185</b>
<b>Table 20</b> - Transshipment authorisations: target information on vessel details	<b>186</b>
<b>Table 21</b> - Transshipment authorisation: target information on vessel history	<b>186</b>
<b>Table 22</b> - Transshipment authorisations: target information & verification process	<b>187</b>
<b>Table 23</b> - Transshipment authorisation: target information	<b>188</b>
<b>Table 24</b> - Transshipment authorisation: verification	<b>188</b>
<b>Table 25</b> - Total catch on board: target information	<b>189</b>
<b>Table 26</b> - Total catch on board: verification	<b>190</b>
<b>Table 27</b> - Check-list: Assessment of AREP	<b>193</b>
<b>Table 28</b> - Elements of the inspection briefing	<b>200</b>
<b>Table 29</b> - Steps during an inspection, and their details	<b>216</b>
<b>Table 30</b> - IOTC port inspection report - Fields 30 and 31	<b>259</b>
<b>Table 31</b> - Procedures for inspection and monitoring offloading from tuna longliner	<b>270</b>
<b>Table 32</b> - Procedures for inspection and monitoring offloading from tuna purse seiner	<b>279</b>
<b>Table 33</b> - Procedures for inspection and monitoring offloading from carrier vessel	<b>288</b>

## Foreword

“This manual is a testament to the accomplishments and ongoing efforts of the Indian Ocean Tuna Commission (IOTC) to prevent illegally caught fish from entering international markets through the ports of IOTC Members.

Following the adoption of the 2009 FAO Port State Measures Agreement – and well before it came into force, the IOTC was one of the first Regional Fisheries Management Organisations to begin systematically addressing its port State responsibilities. In 2010, IOTC adopted its first Port State Measures Resolution, mirroring relevant provisions of the 2009 FAO Port State Measures Agreement and making them binding on its Members. This resolution included the mechanisms and drivers for regional-based actions on the part of flag States, coastal States, port States, market States and the industry i.e. the broad range of stakeholders that need to be engaged for effective implementation and compliance of the measures. Since 2010 the Commission has continued to strengthen its port State measures and take advantage of new technologies. In 2019 it introduced the e-PSM, an innovative electronic system of reporting Port state information to the Secretariat and communicating information between IOTC Members.

The Secretariat hopes that this manual will serve as a cornerstone reference for IOTC Members and their fisheries inspectors as they implement the IOTC port State management measures and continue their efforts to prevent, deter and eliminate illegal, unreported and unregulated fishing in the Indian Ocean.”

Executive Secretary  
Indian Ocean Tuna Commission

## Acknowledgements

The manual updates the original version published in 2013 which was prepared with the financial support of the European Union under the grant *“Technical assistance to developing countries CPC of the IOTC to improve implementation of IOTC CMMs and implementation of Port State Measures”*. This grant is a voluntary contribution of the European Union to the IOTC special fund for capacity building in order to ensure compliance with IOTC Conservation and Management Measures. The capacity building fund is established under the Resolution 16/10. It was updated under the Second South West Indian Ocean Fisheries Governance and Shared Growth Project (SWIOFish2).

The content of the manual was originally developed by Gerard Domingue, Florian Giroux, Christopher Heinecken and Melanie Smith, with technical review assistance from John Davis and Peter Flewelling and with editorial assistance from Kevern Cochrane. It was updated by Judith Swan with technical review by Gerard Domingue, Florian Giroux and Fabio Fiorellato.

The photographs in the manual have been provided by the IOTC secretariat and observers from the IOTC regional observer program to monitor transshipment at sea.

# Abbreviations and acronyms

<b>AFV</b>	Authorised fishing vessel
<b>AIS</b>	Automatic Identification System
<b>ALB</b>	Albacore
<b>AREP</b>	Advance request to enter port
<b>ATF</b>	Authorisation to fish
<b>BET</b>	Bigeye tuna
<b>BIOT</b>	British Indian Ocean Territory
<b>CCAMLR</b>	Commission for the Conservation of Antarctic Marine Living Resources
<b>CCSBT</b>	Commission for the Conservation of Southern Bluefin Tuna
<b>CF</b>	Conversion factor
<b>CMM</b>	Conservation and management measure (of an RFMO)
<b>CPC</b>	Contracting Parties and cooperating non-Contracting Parties
<b>DWFN</b>	Distant water fishing nation
<b>EEZ</b>	Exclusive economic zone
<b>e-PSM</b>	IOTC's electronic PSM system
<b>ETA</b>	Estimated time of arrival
<b>ETD</b>	Estimated time of departure
<b>EU</b>	European Union
<b>FAD</b>	Fish aggregating device
<b>FAO</b>	Food and Agriculture Organisation of the United Nations
<b>FAO PSMA</b>	2009 FAO Port State Measures Agreement
<b>FER</b>	FINSS Enforcement Report
<b>FMC</b>	Fisheries Monitoring Centre
<b>GGT</b>	Gutted, gilled and tail off
<b>GMDSS</b>	Global Maritime Distress and Safety System
<b>GPS</b>	Global positioning system
<b>GSM</b>	Global System for Mobile communication
<b>HDD</b>	Dressed carcasses with head and fins off and caudal peduncles present
<b>IATTC</b>	Inter-American Tropical Tuna Commission

<b>ICCAT</b>	International Commission for the Conservation of Atlantic Tunas
<b>IOC</b>	Indian Ocean Commission
<b>IOTC</b>	Indian Ocean Tuna Commission
<b>IMO</b>	International Maritime Organisation
<b>IPOA</b>	International Plan of Action
<b>IRCS</b>	International radio call sign
<b>ITU</b>	International Telecommunication Union
<b>IUU</b>	Illegal, unreported and unregulated (used in relation to fishing and related activities)
<b>LSTLV</b>	Large-scale tuna longline vessel
<b>MCS</b>	Monitoring, control and surveillance
<b>MoU</b>	Memorandum of understanding
<b>PDD</b>	Dressed carcasses with heads, fins and caudal peduncles off.
<b>PDF</b>	Personal flotation device
<b>PSM</b>	Port State measure
<b>PSMR</b>	Port State measures resolution
<b>RAI</b>	Request for additional information
<b>RAR</b>	Risk assessment report
<b>RAV</b>	Record of authorised vessels
<b>RFMO</b>	Regional fisheries management organisation
<b>SWO</b>	Swordfish
<b>TAL</b>	Dressed carcasses with heads and fins off and caudal peduncles present
<b>UN</b>	United Nations
<b>UNCLOS</b>	United Nations Convention on the Law of the Sea
<b>UNFSA</b>	United Nations Agreement on Straddling and Highly Migratory Fish Stocks (UN Fish Stocks Agreement)
<b>WIO</b>	Western Indian Ocean
<b>WP</b>	Working party
<b>VMS</b>	Vessel monitoring system
<b>WCPFC</b>	The Western and Central Pacific Fisheries Commission
<b>YFT</b>	Yellowfin tuna

# Terms

<b>Fish</b>	All species of highly migratory fish stocks covered by the IOTC Agreement.
<b>Fishing</b>	Searching for, attracting, locating, catching, taking or harvesting fish or any activity which can reasonably be expected to result in the attracting, locating, catching, taking or harvesting of fish.
<b>Fishing related activities, or “related activities”</b>	Any operation in support of, or in preparation for, fishing, including: <ul style="list-style-type: none"> <li>→ landing</li> <li>→ packaging</li> <li>→ processing</li> <li>→ transshipping</li> <li>→ transporting</li> </ul> <p>fish that have not been previously landed at a port, and provisioning personnel, fuel, gear and other supplies at sea.</p>
<b>IUU fishing activities</b>	Illegal, unreported and unregulated fishing activities refer to the activities set out in paragraph 4 of IOTC Resolution 18/03 (which include fishing and fishing related activities).
<b>Port</b>	Includes offshore terminals and other installations for landing, transshipping, packaging, processing, refuelling or resupplying.
<b>Use of Port</b>	Landing, transshipping, packaging and processing of fish that have not been previously landed and other port services including, among others, refuelling and resupplying, maintenance and dry-docking.
<b>Vessel</b>	Any vessel, ship of another type or boat used for, equipped to be used for, or intended to be used for, fishing or fishing related activities.





# Introduction

The sustainable use of living marine resources has been a topic of international focus for many decades. This has resulted in the negotiation and adoption of numerous fisheries agreements and measures by the international community through the United Nations, the Food and Agriculture Organization of the United Nations (FAO), and regional fisheries management organisations (RFMOs).

Worldwide efforts to manage fisheries that extend across national boundaries and the high seas continue to be undermined by illegal, unreported and unregulated (IUU) fishing activities. Port State measures have been recognised as one of the most effective means for enhancing compliance with fisheries management, in terms of both cost and effectiveness. Inspecting a vessel in port is straightforward; it provides a secure and stable environment for personnel to operate and eliminates the risks and costs associated with boarding at sea.

The FAO Agreement on Port State Measures to Prevent, Deter and Eliminate Illegal, Unreported and Unregulated Fishing (FAO PSMA) is the culmination of broad-based cooperation by the international community, including States and RFMOs, to combat IUU fishing activities. It was approved by the FAO Conference on 22 November 2009, and entered into force on 5 June 2016 after ratification by the twenty-fifth party. By February 2021, 67 States and the European Union (EU) had become party.<sup>1</sup>



© IOTC

Figure 1: Transhipment of tunas<sup>2</sup>

- 1 A list of current Parties is at: <http://www.fao.org/port-state-measures/background/parties-psma/en/>.
- 2 Throughout this document figures that are not referred to in the text are illustrations of activities relevant to port State measures.

## Port State measures

### Procedures for the implementation of the Indian ocean Tuna Commission

Following the approval of the FAO PSMA and pending its entry into force, in 2010 the Indian Ocean Tuna Commission (IOTC) adopted Resolution 10/11 on Port State Measures to Prevent, Deter and Eliminate Illegal, Unreported and Unregulated Fishing. The IOTC PSMR mirrored the relevant provisions of the FAO PSMA making them mandatory for IOTC Contracting and Cooperating Non Contracting Parties (CPCs) with effect from 1 March 2011.

The Resolution aimed to combat IUU fishing through the implementation of effective port State measures to control the harvest of fish caught in the IOTC Area, and thereby to ensure the long-term conservation and sustainable use of these resources and marine ecosystems. A general objective of the Resolution was to prevent illegally caught fish from entering international markets through ports of CPCs.



Figure 2: IOTC carrier vessels

Resolution 10/11 was superseded by IOTC Resolution 16/11, which added a provision on an electronic system for port State measures, or e-PSM system, described below in section 3.3.5 of this Manual. The system, based on an application accessible on the IOTC website, supports compliance activities and CPCs are encouraged to use it and provide feedback and inputs contributing to its development.



## CHAPTER 1



# BACKGROUND

## ***IOTC, Indian Ocean Tuna Fisheries, Port State Measures***

**U**nderstanding the fisheries management process of the Indian Ocean Tuna Commission, the fleets and ports involved in the tuna fisheries and the development of port State measures,

---

*This chapter provides background information for three areas that are essential for a clear understanding of the objectives and implementation of port State measures in combatting IUU fishing activities in the IOTC Area.*

**The first section explains the organization and role of IOTC in managing the tuna fisheries in the Indian Ocean region.**

*The second section provides an overview of the Indian Ocean tuna fisheries.*

*The third section presents an introduction and summary of the development of port State measures at the international level and the parallel development of regional conservation and management measures by the IOTC leading up to the adoption of the IOTC PSMR in 2010.*

*It is especially important for both port and fisheries authorities to understand the responsibilities of port States for implementing IOTC conservation and management measures (CMMs). This chapter aims to provide the background to enable such understanding and contribute to the effectiveness of the measures throughout the region.*

# 1

# 1OTC organisation and role

**1.1.**  
Members

---

**1.2.**  
The Commission

---

**1.3.**  
Organisational structure

---



The IOTC was established by an Agreement concluded under Article XIV of the FAO Constitution; it entered into force on 27 March 1996. It is an intergovernmental organisation mandated to manage tuna and tuna-like species in the Indian Ocean and adjacent seas. The area of competence of the IOTC, defined in the Agreement, is subdivided into a western and an eastern portion, which correspond to FAO Statistical Areas 51 and 57 respectively. It is shown in *Figure 3*.

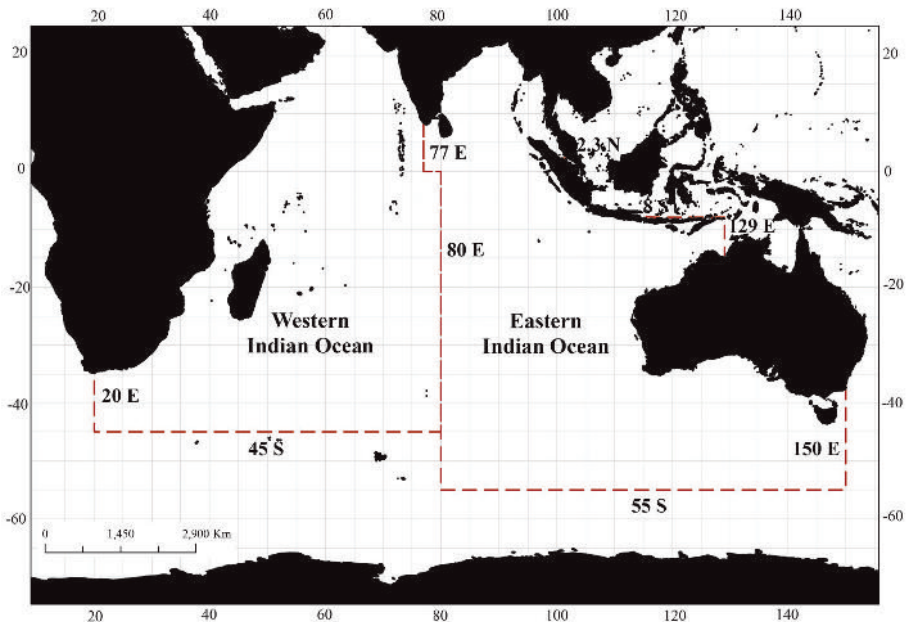

Source: IOTC, 2021

*Figure 3: Area of competence of the Indian Ocean Tuna Commission*

The objective of the Commission is to promote cooperation among its Members with a view to ensuring, through appropriate management, the conservation and optimum utilisation of stocks covered by this Agreement and encouraging sustainable development of fisheries based on such stocks. The IOTC shares these objectives with four other tuna RFMOs covering the ocean regions of the world (*Figure 4*).

## Port State measures

### Procedures for the implementation of the Indian ocean Tuna Commission

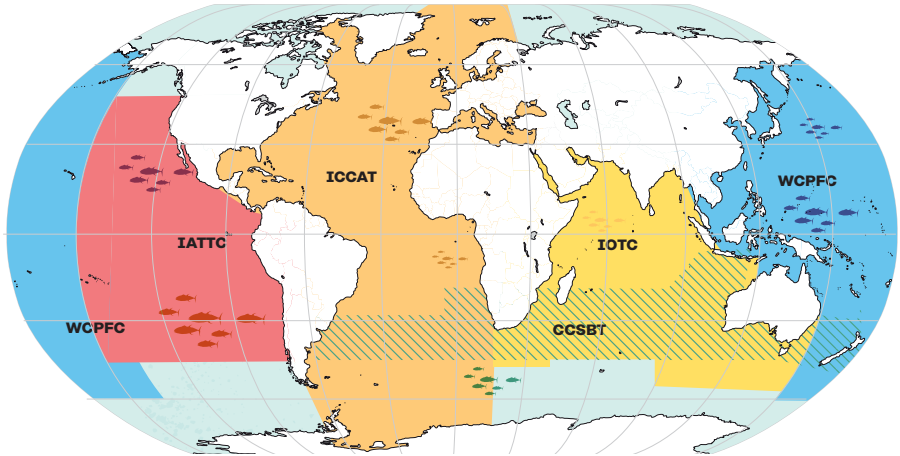

Source: EU, 2021

Figure 4: Five major tuna RFMOs<sup>1</sup> covering the oceanic regions

It is important to note for the purposes of port State measures that vessels fishing in regions managed by other RFMOs adjacent to the IOTC area (CCAMLR, CCSBT, ICCAT and WCPFC) are likely to enter ports in the Indian Ocean region to offload their catch. Those RFMOs have also adopted port State measures similar to (but not the same as) the IOTC PSMR.

Cooperation with the Secretariats and members of those organisations will be an essential aspect in implementing the IOTC PSMR and the FAO PSMA, and will strengthen the fight against IUU fishing activities globally.

<sup>1</sup> They include IOTC, the Commission for the Conservation of Southern Bluefin Tuna (CCSBT), the Inter American Tropical Tuna Commission (IATTC), the International Commission for the Conservation of Atlantic Tuna (ICCAT) and the Western and Central Pacific Fisheries Commission (WCPFC).



## 1.1 Members

The Commission is open to any coastal State or regional economic integration organisation wholly or partly situated in the IOTC Area or whose vessels fish in the Area for stocks covered by the Agreement, and which are members or associate members of FAO or the United Nations or one of its specialised agencies. It is composed of Contracting Parties and Cooperating Non-Contracting Parties (CPCs). Membership in 2020 consisted of 31 Contracting Parties (Members), including the EU, and two Cooperating Non-Contracting Parties (*Table 1*).<sup>2</sup>

---

<sup>2</sup> A list of current members is at <https://www.iotc.org/about-iotc/structure-commission>.

## Port State measures

### Procedures for the implementation of the Indian ocean Tuna Commission

*Table 1 - CPCs of the Indian Ocean Tuna Commission*

Commission Contracting Parties (Members) (Date of acceptance)			
Australia	(13 Nov 1996)	Mauritius	(27 Dec 1994)
Bangladesh	(April 2018)	Mozambique	(13 Feb 2012)
China	(14 Oct 1998)	Oman, Sultanate of	(5 April 2000)
Comoros	(14 Aug 2001)	Pakistan	(27 Apr 1995)
Eritrea	(9 Aug 1994)	Philippines	(9 Jan 2004)
European Union	(27 Oct 1995)	Seychelles	(26 Jul 1995)
France (Territories)	(3 Dec 1996)	Sierra Leone	(01 Jul 2008)
India	(13 Mar 1995)	Somalia	(24 May 2014)
Indonesia	(09 July 2007)	South Africa	(16 Feb 2016)
Iran, Islamic Republic of	(28 Jan 2002)	Sri Lanka	(13 Jun 1994)
Japan	(26 Jun 1996)	Sudan	(3 Dec 1996)
Kenya	(29 Sep 2004)	Thailand	(17 Mar 1997)
Korea, Republic of	(27 Mar 1996)	United Kingdom	(22 Dec 2020)
Madagascar	(10 Jan 1996)	United Republic of Tanzania	(18 Apr 2007)
Malaysia	(22 May 1998)	Yemen	(20 Jul 2012)
Maldives	(13 July 2011)		
Cooperating Non-Contracting Parties to the Indian Ocean Tuna Commission			
Liberia	2015	Senegal	2006

## 1.2 The Commission

**The Commission** as the main decision-making body, is composed of IOTC Members and adopts decisions and recommendations at its annual sessions<sup>3</sup> to further the objectives of the Agreement. Committees and working parties, described below, have specific functions and are responsible to the Commission and refer their conclusions and recommendations to the Commission for final decision-making.

### 1.2.1 Functions and responsibilities

The main functions and responsibilities of the Commission are noted in **Box 1**.

#### Box 1 | Functions and responsibilities of the Commission

*The Commission has the following functions and responsibilities in accordance with the principles expressed in the relevant provisions of the 1982 United Nations Convention on the Law of the Sea and the fish stocks covered by the IOTC Agreement:*

- keep under review the conditions and trends of the stocks;
- gather, analyse and disseminate scientific information, catch and effort statistics and other data relevant to the conservation and management of the stocks and to fisheries;
- encourage, recommend, coordinate research and development activities in respect of the stocks and fisheries, including activities connected with transfer of technology, training and enhancement;
- adopt, on the basis of scientific evidence, conservation and management measures to ensure the conservation of the stocks and to promote the objective of their optimum utilisation; and
- to keep under review the economic and social aspects of the fisheries bearing in mind, in particular, the interests of developing coastal States.

**3** The IOTC Agreement refers to annual meetings as sessions; either term can be used.

In the discharge of its responsibilities, the Commission may undertake such other research and development activities as it may decide, but must have due regard to the need to ensure the equitable participation of its Members in the fisheries and the special interests and needs of Members in the region that are developing countries.

### **1.2.2 Decision-making and Members' implementation responsibilities**

Decisions may be taken by the Commission at IOTC annual sessions to further the objectives of the Agreement, including fisheries conservation and management. They may be in the form of either Resolutions (*Figure 5*) or Recommendations (*Figure 6, Box 2*).

Resolutions are legally binding on Members. They are adopted by a two-thirds majority of Members present and voting. However:

- Individual Members that register an objection to a decision are not legally bound by the Resolution;
- Where more than one-third of the Members object to a measure, then none of the Members are bound by the measure; but this does not preclude any or all of them from giving effect to such a measure.



\* The level of compliance is assessed for each CPC to encourage implementation and contribute to the effectiveness of the Commission.

*Figure 5: Resolutions of the IOTC*



\* Recommendations need only to be adopted by a simple majority of Members present and voting.

Figure 6: Recommendations of the IOTC

Members of the Commission are also expected to cooperate in the exchange of information regarding any fishing for stocks covered by the Agreement by nationals of any State or entity that is not a Member.

### Box 2 | IOTC Resolutions and Recommendations

*Resolutions are binding on the Members of the IOTC. It is their responsibility to ensure that action is taken to implement the Resolutions in their national legislation and then to enforce the legislation.*

*Recommendations are not binding but can be implemented on a voluntary basis*

## 1.3 Organisational structure

The IOTC structure comprises the Secretariat, which carries out the day-to-day operation of the Commission on behalf of its members, three committees and several Working Parties (Figure 7). The Committees, which make recommendations to the Commission, address matters of science, compliance and

## Port State measures

### Procedures for the implementation of the Indian ocean Tuna Commission

administration and finance. The Working Parties, which report to Committees, may be established on a continuous basis or for special issues.<sup>4</sup>

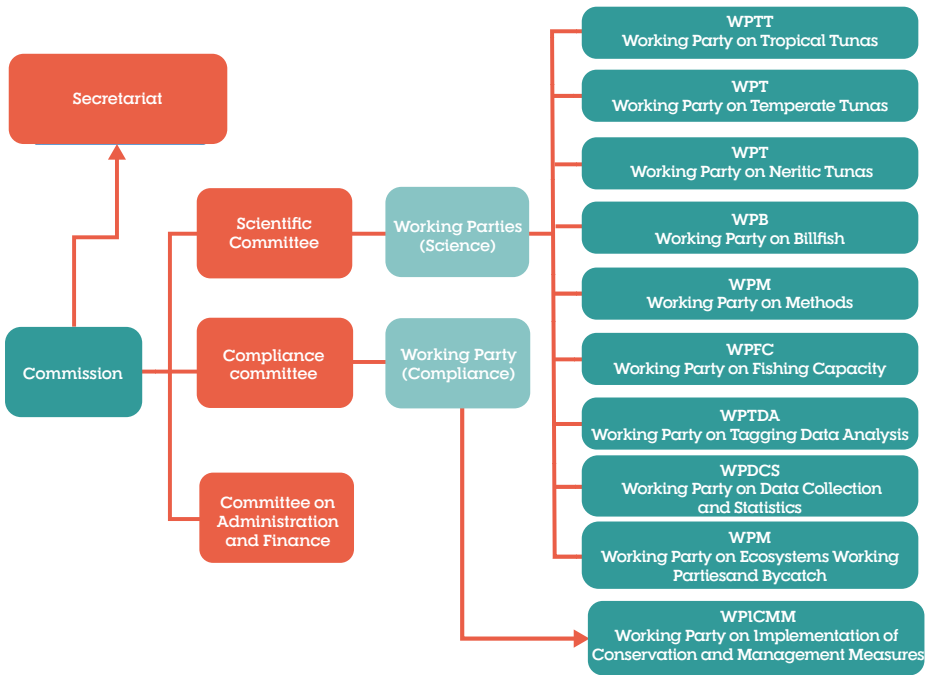

Source: IOTC, 2021

Figure 7: Organigramme of the IOTC organisational structure

### 1.3.1 Secretariat

The offices of the IOTC Secretariat are located in Victoria, Seychelles. The office started its operations on 1 January 1998. In 2021, the Secretariat was composed of a staff complement of about 17 people, covering technical and administrative positions. The organigramme of the Secretariat is in [Figure 9](#).

<sup>4</sup> A list of the current Committees and Working Parties is at <https://www.iotc.org/about-iotc/structure-commission>.

The mission of the Secretariat is to facilitate the processes required to implement the policies and activities of the Commission, whose goal is to achieve the objectives stated in the IOTC Agreement. In essence, these processes include the acquisition, processing and dissemination of information that constitutes the basis for the Commission's decisions, as well as supporting the actions taken by the Members and Cooperating Parties to implement those decisions effectively.

The Strategic Plan of the Secretariat, reviewed annually, describes the core services that the Secretariat provides to Contracting Parties and Cooperating Non-Contracting Parties (CPCs) and other stakeholders to support the work of the Commission. It describes three goals:

- deliver effective administrative, technical and scientific support to the Commission and its subsidiary bodies;
- support the IOTC Members through various capacity building activities to implement their obligations under the Agreement;
- facilitate communication and collaboration among stakeholders through effective dissemination of information.

The tasks of the Secretariat are delivered through five core functions (*Figure 8*):

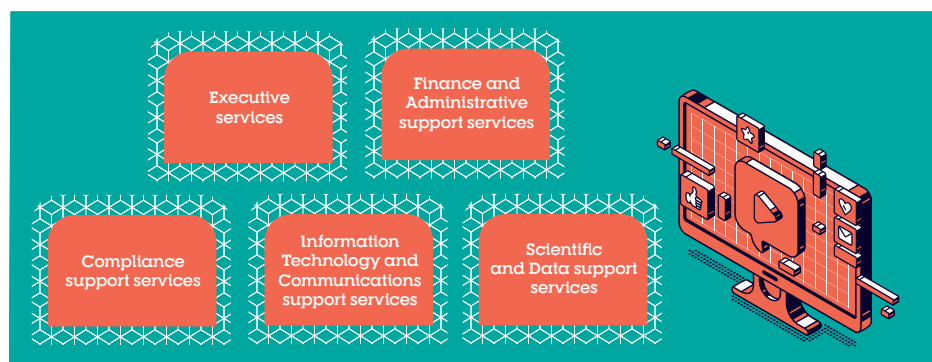

Source: IOTC, 2021

*Figure 8: Core functions of the IOTC Secretariat*

The Secretariat is divided into sections composed of staff with similar specialised skills (*Figure 9*). In order to provide support to the scientific activities of the Commission and its subsidiary bodies, there is close cooperation between the Sections in the production of datasets and analyses that will assist the Scientific Committee and its Working Parties to formulate its advice to the Commission.

Similarly, the Data Section and the Compliance Section cooperate in the maintenance of the databases needed to monitor the effectiveness in the implementation of the measures adopted by the Members.

To facilitate planning, the activities of the Secretariat have been grouped into six major functional areas:

#### **1. Support to scientific activities**

The acquisition and processing of scientific data, as required by the Scientific Committee to conduct stock status analyses or other tasks. Support to stock assessment services as required by working groups.

#### **2. Support to compliance activities**

Review and assess CPCs' implementation of conservation and management measures (CMMs), support development and implementation of monitoring, control and surveillance (MCS) tools, maintain vessel lists and records for IUU, active and authorised vessels, administer/monitor the Vessel Monitoring System, programmes for observers and at-sea transshipments and catch certification/trade documentation schemes, deliver training as needed.

#### **3. Communications and public information**

This function is considered essential in allowing CPCs to follow the progress the Commission's work in a transparent way, and to increase the visibility of the Commission's activities to the general public.

#### **4. Support to meetings**

Logistical support in the facilitation of meetings, preparation of reports and maintenance of the meetings calendar.



## **5. Information Technology**

Provide internet support and basic computer infrastructure, including maintenance of the network and servers.

## **6. Administration**

Financial administration in conjunction with FAO, administration of extra-budgetary funds, travel arrangements and general logistical support to the activities of the technical sections.

The Secretariat is also involved in the implementation of projects that further the objectives of the Commission.

The Secretariat maintains a website, [www.iotc.org](http://www.iotc.org), which provides comprehensive information for the public and confidential information for CPCs, as necessary. It provides CPCs with the information and systems they may need in order to honour their duties under the Agreement.

The Secretariat is managed by the Executive Secretary, who is appointed by the Commission.

## Port State measures

Procedures for the implementation of the Indian ocean Tuna Commission

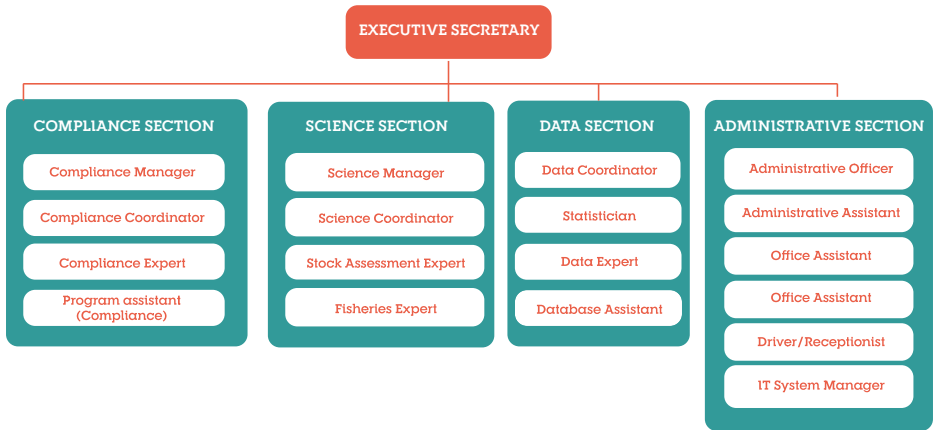

Source: IOTC, 2021

Figure 9: Organisational structure of the IOTC Secretariat

### 1.3.2 Committees

The Commission (*Figure 10*) has established three permanent Committees under its Rules of Procedure: Scientific Committee, Compliance Committee and Administration and Finance Committee.

#### 1.3.2.1 Scientific Committee

The Scientific Committee (SC) recommends policies and procedures for data collection, processing, dissemination and analysis to the Commission, develops research programmes and facilitates research, reports on stock assessments and makes recommendations for conservation and management measures and research. The meetings of the Scientific Committee are held some months prior to the annual Commission sessions to allow CPCs to review the report and recommendations.

The Commission has established a number of Working Parties under the Scientific Committee for specific purposes (**Box 3**). Most Working Parties provide the Scientific Committee with analyses of the status of various stocks and possible management actions and others analyse and provide recommendations on broader issues such as data collection, statistics, methods, ecosystems and bycatch.

### Box 3 | The working parties of the IOTC Scientific Committee

*WPTT - Working Party on Tropical Tunas*

*WPT - Working Party on Neritic Tunas*

*WPDCS - Working Party on Data Collection and Statistics*

*WPB - Working Party on Billfish*

*WPT - Working Party on Temperate Tunas*

*WPM - Working Party on Methods*

*WPM - Working Party on Ecosystems and Bycatch*

#### 1.3.2.2 The Compliance Committee

The Compliance Committee (CoC) is responsible for reviewing all aspects of CPCs' individual compliance with IOTC resolutions in the IOTC Area and reports directly to the Commission on its deliberations and recommendations. Its overall objectives include identification and discussion of problems related to the implementation of, and compliance with, legally binding IOTC Conservation and Management Measures, and to make recommendations to the Commission on how to address such problems.

The Working Party on the Implementation of Conservation and Management Measures reports to the Compliance Committee.

## Port State measures

### Procedures for the implementation of the Indian ocean Tuna Commission



© IOTC

*Figure 10: Commission meeting of the IOTC*



© IOTC

#### 1.3.2.3 The Committee on Administration and Finance

The Standing Committee on Administration and Finance (SCAF) advises the Commission on matters of an administrative and financial character remitted to it by the Commission and examines the operation of the budget for the current year and examines the draft budget for the ensuing year. It reports to the Commission annually.

## 2

# Overview of the Indian Ocean tuna fishery

### 2.1

The tuna resources

---

### 2.2

Ports supporting the Indian Ocean tuna fishery

---

### 2.3

Purse seine fishery

---

### 2.4

The longline fishery

---



## 2.1 The tuna resources

The Indian Ocean tuna fishery is the second largest in the world, with catches estimated at nearly 2 million metric tonnes of tuna and tuna-like species annually or approximately 25 percent of the world tuna catches. The oceanic tunas include skipjack (*Katsuwonus pelamis*), yellowfin (*Thunnus albacares*) and bigeye (*T. obesus*), which are caught by purse seine fisheries, whereas albacore (*T. alalunga*) and southern bluefin (*T. maccoyii*) which, together with yellowfin and bigeye tuna, are caught by longlines. Tuna-like species include principally billfish, with swordfish (*Xiphias gladius*) suffering the highest catches (Figure 11). The status of the stocks by species is available on the IOTC website at: <https://www.iotc.org/science/status-summary-species-tuna-and-tuna-species-under-iotc-mandate-well-other-species-impacted-iotc>.

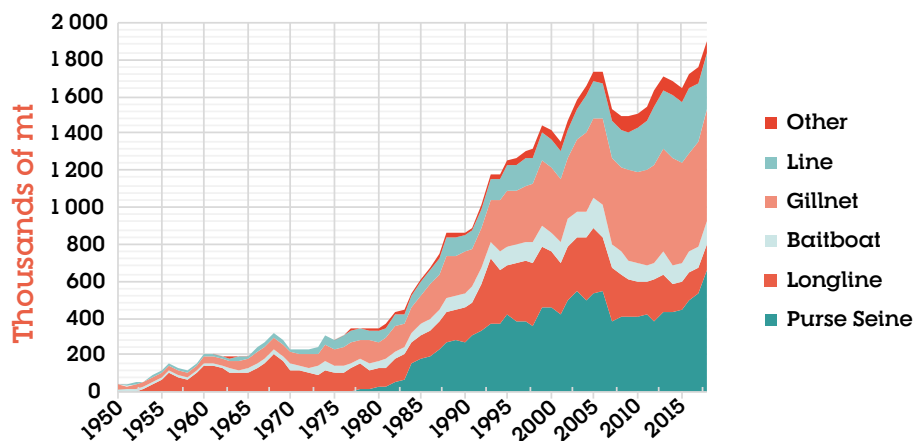

Figure 11: Total catches (thousands of metric tons) of major IOTC species (YFT: yellowfin tuna, BET: bigeye tuna, SKJ: skipjack tuna, ALB: albacore, SWO: swordfish), and other species

Catches of IOTC species in the Indian Ocean increased gradually from the early 1950s to the early 1980s, following the arrival of industrial longline fleets

## Port State measures

### Procedures for the implementation of the Indian ocean Tuna Commission

in the Indian Ocean and development of artisanal fisheries in some coastal States (*Figure 11*).

The dramatic increase in the catches recorded thereafter is the consequence of the arrival of industrial purse seine fleets, in particular those from the EU, and the increased activities of longline (since the late 1980s) and gill-net (since the early 1990s) fleets in the Indian Ocean. The catches of IOTC species have dropped to around 1,500,000 metric tons during years of piracy (2007-2012), then recovered and exceeded pre-piracy levels from 2016 onwards.

In recent years, as much as 40 percent of the catches of IOTC species in the Indian Ocean have been taken by industrial purse seine and longline fleets. Tropical tunas dominate the catches, representing around 60 percent of the total catches of IOTC species in the Indian Ocean (*Figure 12*).

The Indian Ocean tuna fishery can be categorised into several fleet segments depending of the target species:

- Industrial tuna purse seiners targeting tropical tunas are from the European Union, Seychelles, Mauritius, Korea and Japan.
- Industrial coastal purse seiners targeting neritic tuna species are from: Thailand, Malaysia, Indonesia.
- Industrial deep-freezing longliners targeting tuna or swordfish are from Taiwan, Japan, China, India.
- Industrial freezing longliners targeting swordfish are from the European Union and Australia.
- Fresh tuna longliners targeting tropical tunas or swordfish are from Indonesia, Malaysia, European Union and Seychelles.

In the Western Indian Ocean (WIO), the annual catch of the oceanic tuna fishery has reached a total of 970,000 tonnes in 2018. Inclusion of "tuna-like" species brings the total catch of this region to around 1,400,000 tonnes: these landing values are almost three times greater than those of the Eastern Indian Ocean and are associated with the high levels of productivity from upwellings adjacent to the Arabian and Somali coastlines.



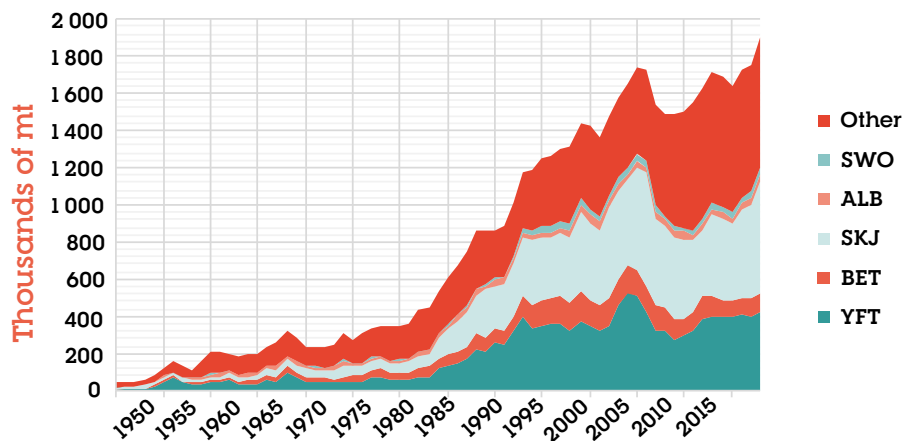

Source: IOTC, 2021

Figure 12: Total catches (thousands of metric tons) of IOTC species, by type of gear and year (1950-2018)

Indian Ocean tuna and 'tuna-like' fisheries are unique for two main reasons:

- Catches taken by the artisanal sector are similar in volume to those of the industrial sector.
- Until the end of the years of piracy (2007-2012), catches taken by the industrial sector were fairly evenly split between longline and purse seine fleets.

This is in contrast to tuna fisheries in both the Pacific and Atlantic Oceans, which are dominated by the industrial sector. The WIO fisheries are estimated to be one of the most valuable in the world (after the WCPFC) and this status reflects two important characteristics:

- the comparatively high value attributed to artisanal catches; and
- that half of the industrial fleet's catches are taken by longliners for which catch values are considerably greater than for equivalent purse seine catches.

Revenues from the tuna fisheries are generated, inter alia, through:

- the sale of fishing rights and access to foreign fleets (predominantly distant water fishing nations (DWFNs) in the form of fisheries agreements);
- transshipment and associated downstream activities of foreign fleets;
- onshore processing and canning of tuna;
- servicing, refuelling, drydocking; and
- landings (and associated activities) of local semi-industrial and industrial enterprises.

Details of vessels authorised to fish and tranship in the IOTC management area can be obtained from the IOTC website, (<http://www.iotc.org>). There are currently 5,837 authorised vessels from 30 flags in the IOTC record of authorised vessels (RAV) (last update: 22 February 2021).

## **2.2. Ports supporting the Indian Ocean tuna fishery**

### **2.2.1. The flow of tuna catches: in port versus at-sea transshipment**

During 2009, as much as 50 percent (longline) and 80 percent (purse seine) of the catches of IOTC species were unloaded in foreign ports within the territory of Indian Ocean coastal States. Most of the catches within this component originate from vessels flagged in DWFNs.

The majority of catches of vessels flagged in coastal States of the Indian Ocean are unloaded in ports within the flag States of the vessel (70 percent for longline and 60 percent for purse seine). The reasons for this difference are probably the relatively small size of vessels flagged in coastal States, compared with those flagged in DWFNs, and the shorter distance between ports in the region and fishing grounds exploited by vessels of coastal States. In addition, 25 percent of the catches of longline fleets are transhipped on the high seas, mostly by vessels flagged in distant water fishing nations (**Box 4**).

#### Box 4 | Flow of tuna catches in the Indian Ocean (Source IOTC 2009)

##### *For purse seiners:*

- All catches are unloaded in port with 80 percent of the catch unloaded in foreign ports.
- For longliners:
  - Twenty-five percent of the catch is transhipped at sea.
  - Fifty percent of the catch is unloaded in foreign ports.
  - Twenty-five percent of the catch is unloaded in ports within the territory of the flag state of the vessels or, to a lesser extent, in foreign ports outside the Indian Ocean.
- Longliners from DWFN tend to use foreign ports or tranship catch at sea (≈90 percent).
- Longliners from Coastal countries tend to unload catch in ports (≈95 percent), mostly within their flag states (≈70 percent).

### 2.2.2. Activities in ports

A number of countries throughout the region have ports frequently utilised for services and off-loading catch (*Figure 13* and *Figure 14*) by foreign fishing vessels with the main countries being:

- Madagascar (Antsiranana)
- Mauritius (Port Louis)
- Seychelles (Victoria)
- Singapore
- South Africa (Durban and Cape Town)
- Thailand (Phuket).

Others countries have ports utilised by foreign fishing vessels but to a lesser extent than the previous ports. They are Mozambique (Maputo, Beira), Sri Lanka (Colombo, Galle) and Kenya (Mombasa).

## Port State measures

Procedures for the implementation of the Indian ocean Tuna Commission

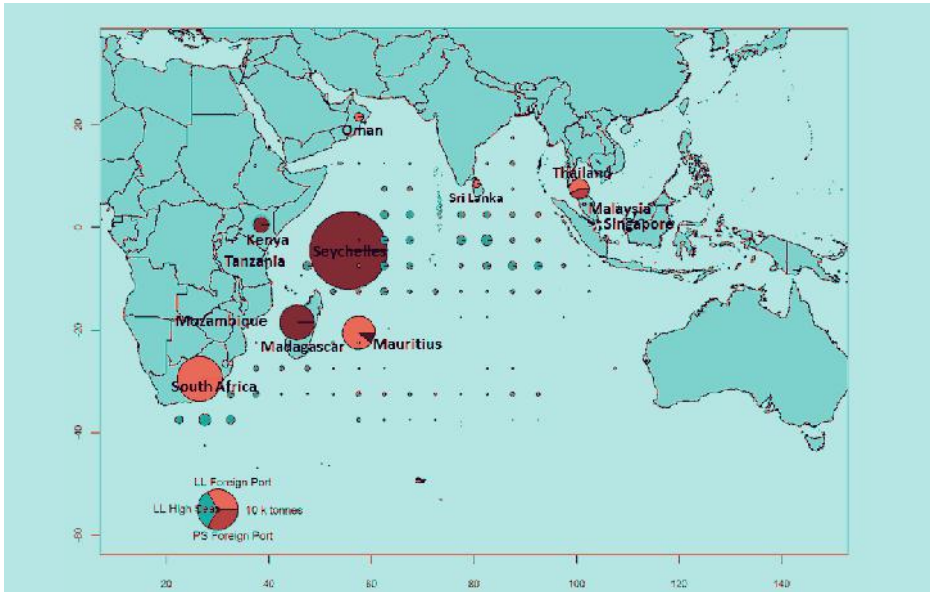

Source: IOTC, 2021

**Figure 13:** Amount of catch unloaded by foreign vessels in ports within the territory of IOTC coastal States and catches transhipped on the high seas by longline vessels under the IOTC Transhipment Programme, (2009), by type of gear

The use of the ports by the foreign fleets in the Indian Ocean follows a specific pattern by type of vessel and gear:

- Tuna purse seiners mostly use Madagascar and Seychelles ports.
- Deep-freezing longliners use Mauritius, Singapore and South Africa ports.
- Freezing longliners (swordfish) use Mauritius and South Africa ports.
- Fresh-tuna longliners use Mauritius, Sri Lanka and Thailand ports.

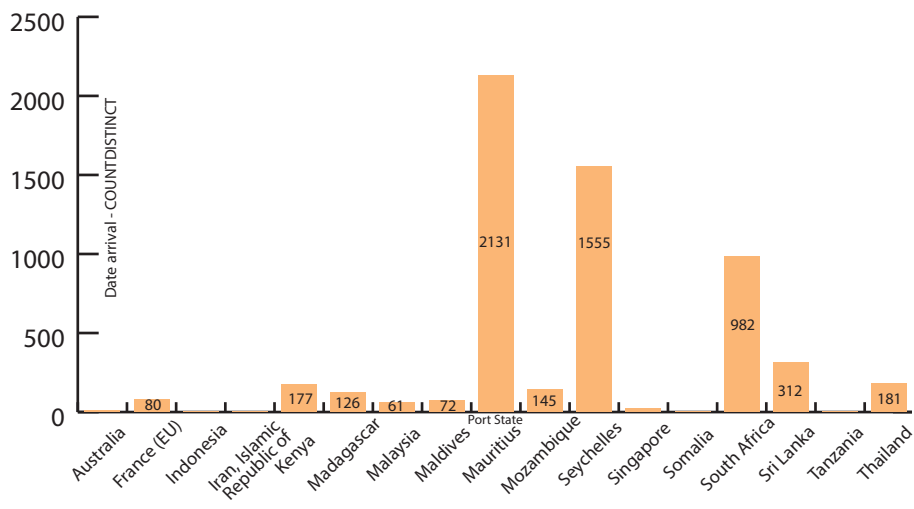

Source: IOTC, 2021

**Figure 14:** Indian Ocean region ports predominantly used for off-loading and port services (Annual number of vessels calling into ports in the Indian Ocean region, source IOTC e-PSM 2020)

The IOTC PSMR<sup>7</sup> requires all CPCs to designate and publicise the ports to which vessels may request entry and provide a list of its designated ports to the IOTC Secretariat. As at 21 February 2021, a total of 19 countries had designated a total of 154 ports. The current list of ports, including the competent authorities and required period for vessels to make an advance request for port entry, is available on the IOTC website at <https://www.iotc.org/compliance/port-state-measures>.

### 2.3. Purse seine fishery

There were 281 purse seine vessels on the IOTC RAV in February 2021<sup>8</sup> of which 134 were active<sup>9</sup>. Nine countries and the EU have tuna purse seine vessels authorised to fish in the Indian Ocean region. The EU (70 percent Spanish or French flagged), Seychelles, Iran, Korea and Japan have largest fleets of industrial tuna purse seiners that target tropical tunas.

<sup>7</sup> Part 2 Paragraph 5.

<sup>8</sup> A current record of authorised vessels is at <https://www.iotc.org/vessels/current>.

<sup>9</sup> A current record of active vessels is at <https://www.iotc.org/vessels>.

## Port State measures

### Procedures for the implementation of the Indian ocean Tuna Commission

Smaller coastal purse seiners targeting neritic tuna species are flagged to Malaysia and Indonesia with the other vessels flagged by Australia, Oman, and Philippines. The EU fleet accounts for a third of the overall Indian Ocean catch and two-thirds of the Western Indian Ocean purse seine catch.

The purse seine activity is almost exclusively distributed in the tropical areas of the WIO region (*Figure 15* & *Figure 16*). However there is a noticeable shift in effort in the region corresponding to the seasons:

- first quarter, Central WIO, Seychelles plateau and northern Mozambique Channel;
- second quarter, southern Somali basin and Mozambique Channel;
- third quarter, Somali basin and western Seychelles plateau;
- fourth quarter, Central WIO and Seychelles plateau.

## Average yearly catches by gears (mt) 2009 - 2018

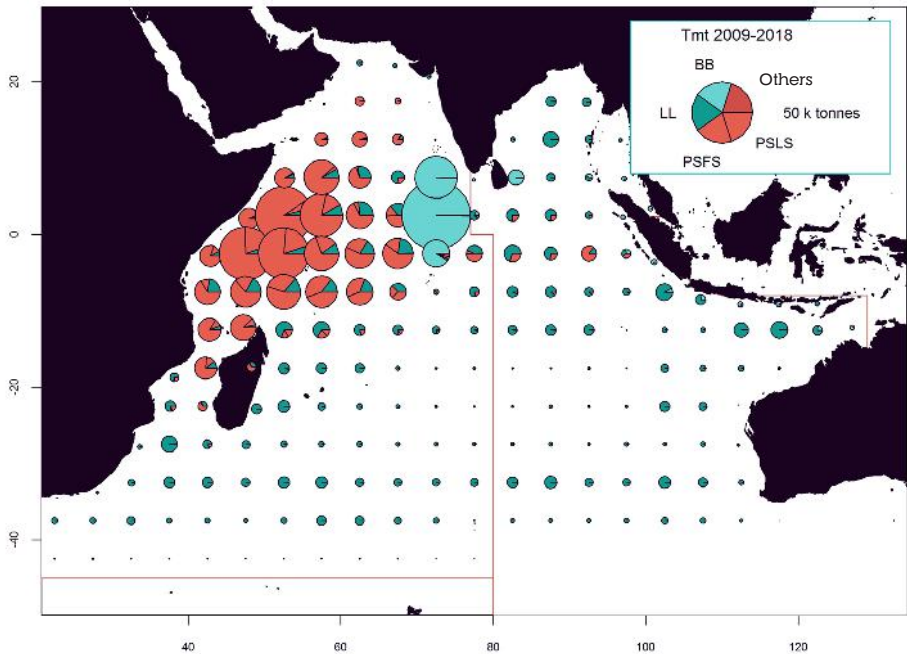

Source: IOTC, 2021

**Figure 15:** Catches of major IOTC species (Tropical tunas, albacore and swordfish) by industrial fleets in the Indian Ocean by type of gear (LL: Longline, BB: Baitboat, PSFS: purse seine free-schools, PSLs: purse seine associated schools) and 5 degrees square area for the period 2000-2018 (Excludes gillnet fisheries)

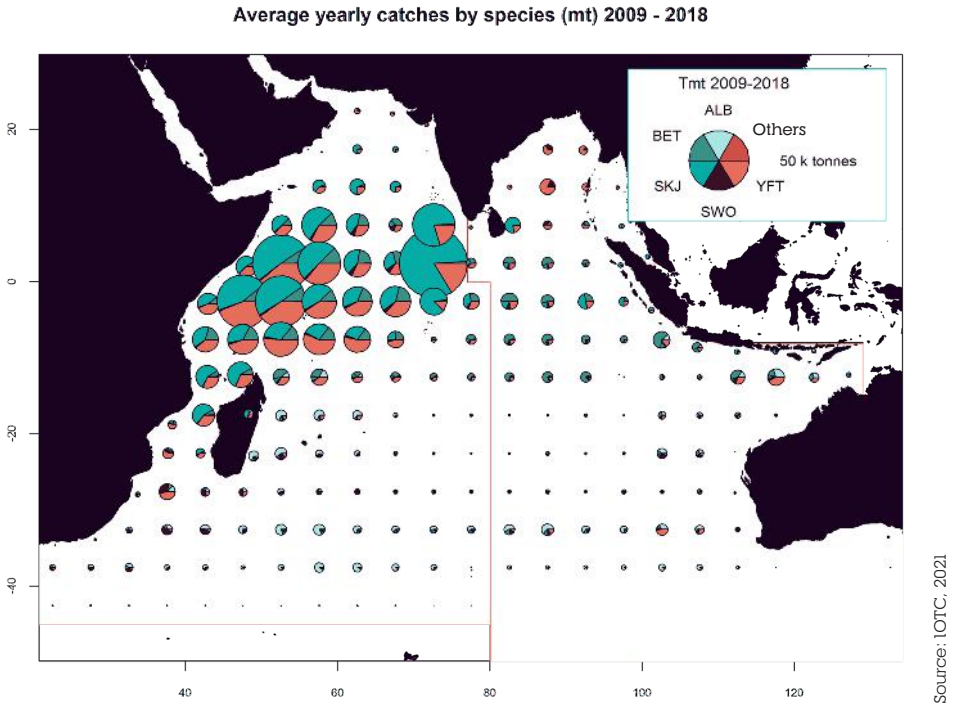

Source: IOTC, 2021

**Figure 16:** Catches of major IOTC species (YFT: yellowfin tuna, BET: bigeye tuna, SKJ: skipjack tuna, ALB: albacore, SWO: swordfish) by industrial fleets in the Indian Ocean by species and 5 degrees square area for the period 2000-2018 (Excludes gillnet fisheries)

## 2.4. The longline fishery

There were 1,431 longline vessels on the IOTC record of authorised vessels in February 2021.<sup>10</sup> The longline fishing is more dispersed ranging over the entire tropical and subtropical areas down to the southern limits of the WIO region.

It is important to note these seasonal shifts (*Figure 17*), as they provide some indication of where fishing fleets will be at certain times of the year and in which region vessels are likely to tranship or request access to port.

<sup>10</sup> A current record of authorised vessels is at <https://www.iotc.org/vessels>



Average Q1 LL catches by species (mt) 2009 - 2018

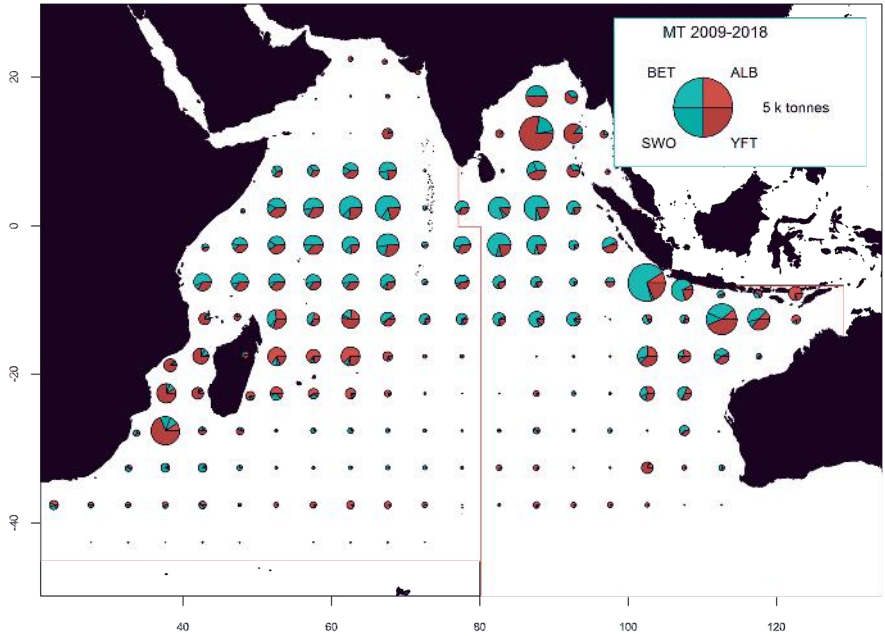

## Port State measures

Procedures for the implementation of the Indian ocean Tuna Commission

Average Q2 LL catches by species (mt) 2009 - 2018

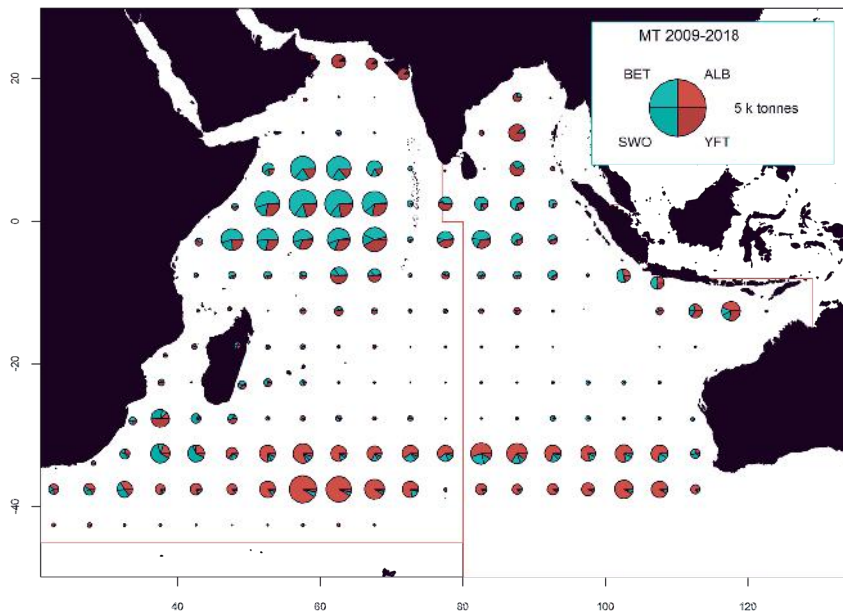

Source: IOTC, 2021

Average Q3 LL catches by species (mt) 2009 - 2018

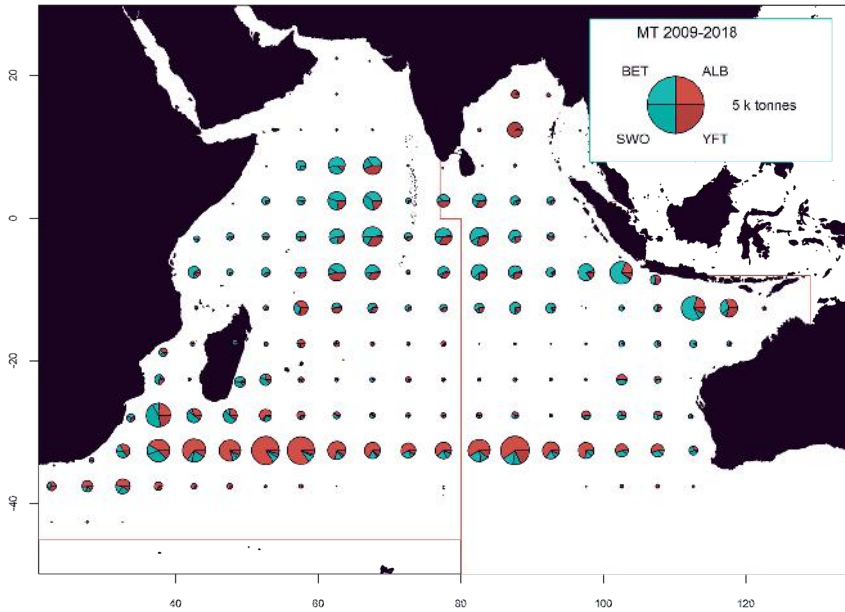

Source: IOTC, 2021

## Port State measures

Procedures for the implementation of the Indian ocean Tuna Commission

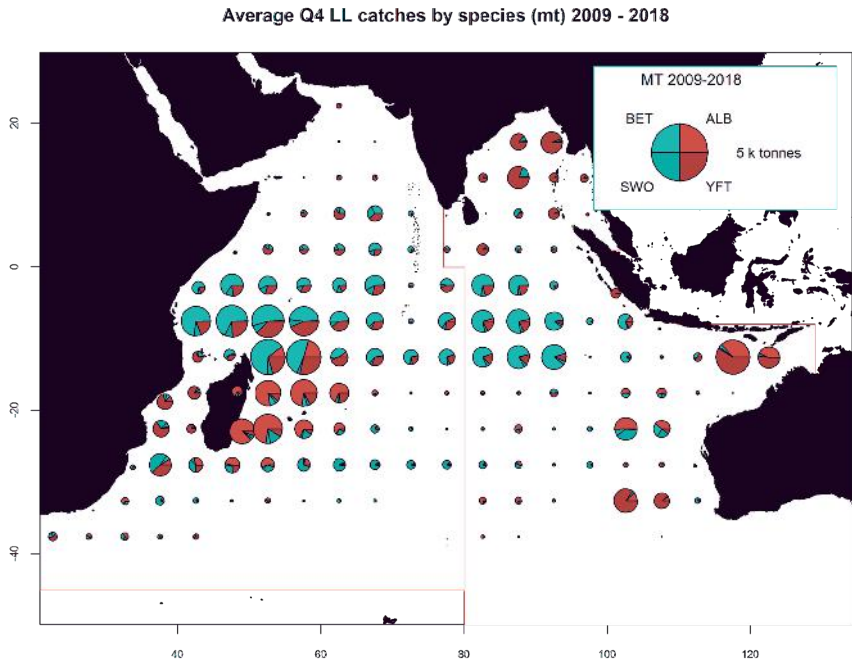

Source: IOTC, 2021

Figure 17: Quarterly average catches by longliners during the period 1994-2018 by season

# 3

## Background to the development of port State measures

### 3.1

Background on the development  
of the FAO Agreement  
on Port State Measures

---

### 3.2

Review of IOTC Resolutions on MCS  
relevant to Port State Measures

---



### 3.1. *Background on the development of the FAO Agreement on Port State Measures*

To implement IOTC PSMR and understand its content, administrators and operational enforcement personnel must have an overall understanding of the evolution and content of international fisheries instruments developed by the UN and FAO relevant to Port State Measures (*Box 5*), as well as the range of complementary IOTC Resolutions that have been adopted over the years.

International fisheries instruments may be either (a) legally binding on countries either directly or as they develop legally binding resolutions through RFMOs or (b) voluntary.

The FAO PSMA and the IOTC PSMR are both legally binding and expressly represent minimum standards to be applied; more stringent requirements may be adopted by RFMOs or countries.

#### Box 5 | Background to the development of Port State Measures

*International instruments that progressively developed port State measures to combat IUU Fishing*

- United Nations Convention on the Law of the Sea (1982)
- FAO Compliance Agreement (1993)
- UN Fish Stocks Agreement (1995)
- FAO International Plan of Action to Prevent, Deter and Eliminate Illegal, Unreported and Unregulated Fishing (2001)
- Model Scheme on Port State Measures (2005)
- FAO Agreement on Port State Measures to Prevent, Deter and Eliminate IUU Fishing (2009).

## Port State measures

### Procedures for the implementation of the Indian ocean Tuna Commission

Voluntary instruments, such as the FAO Code of Conduct for Responsible Fisheries or International Plan of Action to combat IUU fishing activities are not legally binding, and because of that countries are likely to agree on a broader range of areas. However, the provisions may reflect international standards and provide a basis for subsequent legally binding measures.

Port State Measures were addressed in the 1982 United Nations Convention on the Law of the Sea (UNCLOS), but not in relation to fisheries. Its focus was environmental; it provided conditions for the port State to take against vessels voluntarily in port where there was evidence that they had discharged pollutants into the marine environment,<sup>11</sup>

Two new legally binding international fisheries agreements were adopted during the next decade:

#### → 1993 FAO Compliance Agreement.<sup>12</sup>

This Agreement did not provide any port State measures. Instead, there was a loose obligation for port States to cooperate internationally. Where a port State reasonably believed that a vessel had undermined the effectiveness of RFMO CMMs, it was to notify the flag State. The port State was given no express authority to investigate. This Agreement (*Figure 18*) focuses on high seas activities and has largely been superseded.



Figure 18: The 1993 FAO Compliance Agreement

<sup>11</sup> Article 218.

<sup>12</sup> FAO Agreement to Promote Compliance with International Conservation and Management Measures by Fishing Vessels on the High Seas. CPCs party to the Compliance Agreement in February 2021 were Australia, European Union, Japan, Madagascar, Mauritius, Mozambique, Oman, Philippines, Republic of Korea, Senegal, Seychelles, Sri Lanka, United Republic of Tanzania. The status of the Agreement and a list of current parties is at: <http://www.fao.org/iuu-fishing/international-framework/fao-compliance-agreement/en/>.



### → 1995 UN Fish Stocks Agreement.<sup>13</sup>

This Agreement (*Figure 19*) is a more comprehensive instrument that applies to highly migratory and straddling fish stocks and for the first time the rights and duties of port States were recognised (*Box 6*). Specific measures had yet to be developed.

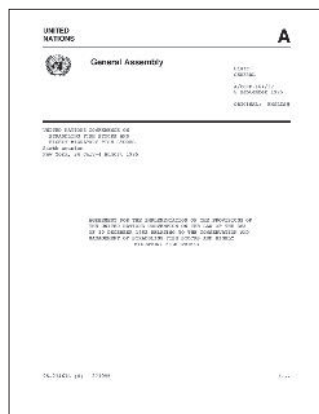

*Figure 19: 1995 UN Fish Stocks Agreement*

**13** Agreement for the Implementation of the Provisions of the United Nations Conventions on the Law of the Sea of 10 December 1982, relating to the Conservation and the Management of Straddling Fish Stocks and Highly Migratory Fish Stocks. CPCs party to the Fish Stocks Agreement in February 2021 are Australia, European Union, India, Indonesia, Iran (Islamic Republic of), Japan, Kenya, Mozambique, Oman, Republic of Korea, Maldives, Mauritius, Philippines, Senegal, Seychelles, South Africa, Sri Lanka, Thailand. The status and a list of current parties is at: [https://www.un.org/Depts/los/convention\\_agreements/convention\\_overview\\_fish\\_stocks.htm](https://www.un.org/Depts/los/convention_agreements/convention_overview_fish_stocks.htm).

## Port State measures

Procedures for the implementation of the Indian ocean Tuna Commission

### Box 6 | UN Fish Stocks Agreement and Port State Measures

*Article 23 of the Agreement recognised the rights and duties of a port State as follows:*

- A port State has the right and the duty to take measures, in accordance with international law, to promote the effectiveness of sub regional, regional and global conservation and management measures.
- A port State may, inter alia, inspect documents, fishing gear and catch on board fishing vessels, when such vessels are voluntarily in its ports or at its offshore terminals.
- States may adopt regulations empowering the relevant national authorities to prohibit landings and transshipments where it has been established that the catch has been taken in a manner which undermines the effectiveness of sub regional, regional or global conservation and management measures on the high seas.

Two voluntary international fisheries instruments were adopted during the following decade:

→ **2001 FAO International Plan of Action to Prevent, Deter and Eliminate Illegal, Unreported and Unregulated Fishing (IPOA-IUU)**

This Plan of Action (*Figure 20*) describes measures and actions to combat IUU fishing that should be taken by all States, flag States, coastal States and port States. It also elaborates internationally agreed market-related measures, research and RFMOs.

The port State measures are in paragraphs 52-64, and many of them formed the foundation for developing stronger measures in the FAO PSMA. For example it: defined the use of port for which access may be given to foreign fishing vessels as including refuelling, re-supplying, transshipping and landing; and required an advance request to enter port so that the likelihood of IUU fishing could be assessed, but it did not go so far as to refer to the denial of entry as does the FAO PSMA.

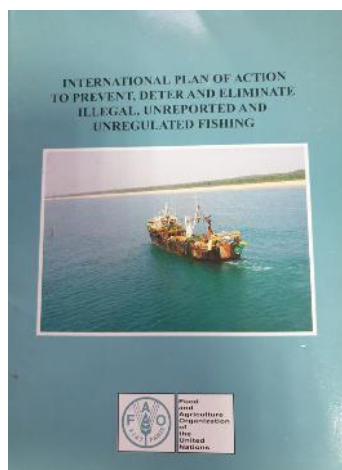

*Figure 20: 2001 FAO IPOA to Prevent, Deter and Eliminate IUU Fishing*

Similarly, requirements for information and inspection of vessels in port are encouraged, but general grounds for denial of the use of port are not specified.

**Box 7 | FAO IPOA-IUU and Port State Measures**

*Paragraph 62 - States should cooperate, as appropriate, bilaterally, multilaterally and within relevant regional fisheries management organisations, to develop compatible measures for port State control of fishing vessels.*

## Port State measures

### Procedures for the implementation of the Indian ocean Tuna Commission

However, the IPOA-IUU encouraged port states to prohibit landings and transshipments where non-CPC vessels were fishing in an area of a relevant RFMO and couldn't prove that they were fishing legally.

It championed national strategies and enhanced cooperation (**Box 7**), including through information exchange among and between relevant RFMOs and States on port State control.

The IPOA-IUU planted the seeds for the FAO PSMA by urging States to cooperate to develop compatible measures for port State control of vessels involved in fishing and related activities. It suggested that measures should deal with the information to be collected by port States, procedures for information collection, and measures for dealing with suspected infringements.

#### → **2005 Model Scheme on Port State Measures (2005 Model Scheme)**

The 2005 FAO Model Scheme (**Figure 21** and **Box 8**) on Port State Measures to Combat Illegal, Unreported and Unregulated Fishing (2005 FAO Model Scheme) was the first step to elaborate and strengthen the port State measures in the IPOA-IUU.

FAO members were unable to agree on a legally binding instrument at the time. The Model Scheme (*Figure 21, Box 8*) recommends minimum standards for port State measures, based on the measures agreed in the IPOA-IUU, PSMs, requiring appropriate implementation at the regional or national level.

The minimum standards relate to the inspection of vessels while they are in port, actions to be taken when an inspector finds there is reasonable evidence for believing that a foreign fishing vessel has engaged in, or supported, IUU fishing activities, and information that the port State should provide to the flag State. The Scheme provides that it should be implemented in a fair, transparent and non-discriminatory manner.

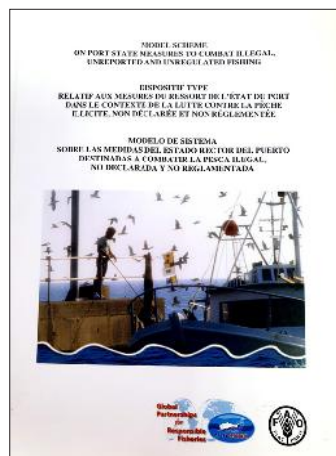

*Figure 21: Model Scheme on Port State Measures (2005)*

The 2005 FAO Model Scheme has five technical appendices upon which its operations depend. These focus on:

- information to be provided in advance by foreign fishing vessel wishing to enter port;
- port State inspection procedures;
- results of inspections;
- training of inspectors;
- information on port State inspections.

The purpose of the appendices is to promote the uniform and harmonised application of the Scheme amongst countries and assist masters of foreign fishing vessels to comply with the port State measures adopted regionally.

## Port State measures

### Procedures for the implementation of the Indian ocean Tuna Commission

In 2005 the FAO Committee on Fisheries (COFI) endorsed the Scheme and agreed that follow-up work should be undertaken, especially with respect to operationalising it, and the FAO Council concurred. This laid the groundwork for development of a legally binding agreement on port State measures.

#### Box 8 | FAO Model Scheme on Port State Measures

*The Model Scheme is a non-binding instrument that was designed to promote and reinforce the implementation of the IPOA-IUU and served as an intermediate step in the development of the binding 2009 FAO Agreement on Port State Measures. It is addressed to all States, fishing entities and RFMOs and its purpose is "to facilitate the implementation of effective action by port States to prevent, deter and eliminate illegal, unreported and unregulated fishing".*

#### → The FAO Port State Measures Agreement (2009)

In 2006, calls were made in the UN system (including the 1995 UN Fish Stocks Agreement Review Conference and General Assembly Resolution 61/05 on Sustainable Fisheries) for a legally binding instrument on port State measures and in 2007 COFI called for such an agreement to be developed by 2009. The Agreement on Port State Measures to Prevent, Deter and Eliminate Illegal, Unreported and Unregulated Fishing (PSMA) was adopted by the FAO Conference in 2009 and entered into force in 2016 with twenty-five parties. February 2021, 67 States and the EU (including 27 member countries) were parties.

The objective of the FAO PSMA is to prevent, deter and eliminate IUU fishing to ensure the long-term conservation and sustainable use of living marine resources and marine ecosystems. The Agreement recognises the sovereignty of parties over their ports as well as their internal, archipelagic and territorial waters and their sovereign rights over their continental shelf and exclusive economic zone.

The PSMA sets minimum standards and applies to IUU fishing and to fishing related activities in support of such fishing. "Fishing related activities" are defined as any operation in support of, or in preparation for, fishing, including the landing, packaging, processing, transshipping or transporting of fish that have not been previously landed at a port, as well as the provisioning of personnel, fuel, gear and other supplies at sea"

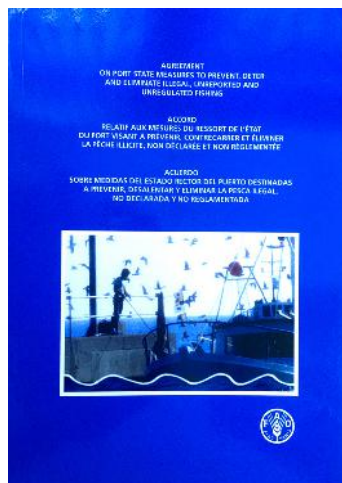

Figure 22: 2009 FAO Port State Measures Agreement to Prevent, Deter and Eliminate IUU Fishing

It applies mainly to foreign vessels - which include any "vessel...equipped to be used for or intended to be used for fishing or fishing related activities" (section 2.1) " - that are seeking entry into a country's port or are in one of its ports. Where there are reasons to believe that a fishing or transport/carrier vessel has IUU caught fish on board that have not been previously landed, the port State must deny entry into port or use of port in specified circumstances.

The use of port must be denied in specified circumstances after entry into port, **before or after** inspection. They include where a vessel has no authorisation to fish by the flag State or a coastal State (in its waters), clear evidence that the fish on board was taken in contravention of applicable requirements of a coastal State a flag State does not confirm that the catch was taken in accordance with measures of an applicable RFMO and otherwise where there are reasonable grounds to suspect IUU fishing or related activities.

## Port State measures

### Procedures for the implementation of the Indian ocean Tuna Commission

"Use of port" refers to for landing, transshipping, packaging and processing of fish that have not been previously landed and for other port services, including, inter alia, refuelling and resupplying, maintenance and drydocking (section 2.1).

These measures will be effective against vessels where their flag States are either unwilling or ineffective in controlling their activities and will support cooperating flag States that have difficulties in controlling their vessels.

The efficient implementation of port State measures and cooperation among States and regional entities will impact directly on the movement and sale of IUU fish, making these ventures unprofitable and eventually uneconomic for operators involved in such operations.

To facilitate understanding and implementation of the FAO PSMA and the IOTC PSMR, a FAO publication is available that explains the background to the PSMA, provides a legislative template, outlines necessary procedures to be developed and explains the role of RFMOs.<sup>14</sup>

The structure of the PSMA includes 10 Parts, 37 Articles and 5 Annexes (**Box 9** shows the Parts and Annexes).

---

<sup>14</sup> Swan, J. "Implementation of Port State Measures", available at <http://www.fao.org/3/a-i5801e.pdf>. Available in English, French and Spanish.



### Box 9 | Outline of the structure of the FAO Port State Measures Agreement

- Annex A: Information to be provided in advance by vessels requesting port entry
- Annex B: Port State inspection procedures
- Annex C: Report of the results of the inspection
- Annex D: Information systems on port State measures
- Annex E: Guidelines for the training of inspectors.

The following IOTC CPCs were party to the FAO PSMA in September 2020<sup>15</sup>: Australia, Bangladesh, EU, Indonesia, Japan, Kenya, Liberia, Madagascar, Maldives, Mauritius, Mozambique, Oman, Philippines, Republic of Korea, Seychelles, Somalia, South Africa, Sri Lanka and Sudan.

**15** A list of current parties is at: <http://www.fao.org/port-state-measures/background/parties-psma/en/>.

### **3.2. Review of IOTC Resolutions on MCS relevant to Port State Measures**

The IOTC Commission has adopted a series of Resolutions since 2001 relating to fisheries monitoring, control and surveillance (MCS) that feature, include or support measures and actions to be taken at port and implement international standards endorsed or adopted by the UN and FAO (*Box 10*). The IOTC PSMR, adopted in 2010, (Resolution 10/11) was almost identical to the FAO PSMA and was amended in 2016 (Resolution 16/11 (*Box 11*)) to include electronic reporting (e-PSM), as described below. This section describes the Resolutions developed since 2001 that are complementary to the IOTC PSMR.

In Resolution 99/03 *On the elaboration of a control and inspection scheme*, the Commission noted that international laws were evolving around international control and inspection processes and tasked the Contracting Parties to submit to the Secretariat proposals and suggestions for future discussion, and the adoption of a control and inspection scheme that would contain all the necessary elements to ensure adequate control and enforcement of management measures for both Contracting and non-Contracting Parties.

A scheme to promote compliance by non-contracting party vessels with IOTC Resolutions was adopted in 2001 (Resolution 01/03). It requires CPCs to report details of such vessels suspected of fishing contrary to IOTC CMMs<sup>9</sup> to the flag State of the vessel and to the IOTC Secretariat, which, in turn, must notify the other CPCs. Importantly, the reporting establishes a presumption that the vessel was undermining IOTC conservation and management measures.

If the reported vessel voluntarily enters a port of a CPC it must:

*be inspected by authorised Contracting Party officials knowledgeable of IOTC measures and shall not be allowed to land or tranship any fish until this inspection has taken place. Such inspections shall include the vessel's documents, logbooks, fishing gear, catch on board and any other matter relating to the vessel's activities in the IOTC Area.*

Landings and transshipments are then prohibited where the inspected vessel has onboard species subject to IOTC Conservation or Management Measures.

A programme of port inspection was first developed in 2002 and superseded in 2005 (Resolutions 02/01 and 05/03). It is very basic and relatively narrow in scope, limiting inspection by CPCs to "documents, fishing gear and catch on board" fishing vessels voluntarily in ports. However CPCs must adopt regulations to prohibit landings and transshipments where the catch undermines IOTC CMMs. Evidence of violations must be notified to the flag State and, as appropriate, the Commission.

In addition to measures on port inspection and prohibitions, IOTC measures were adopted relating to flag State responsibilities, mindful that flag States must exercise effective control over their vessels. In 2007, an IOTC record of fishing vessels was established (Resolution 07/02) consisting of vessels that are authorised to fish for tuna and tuna-like species in the IOTC Area (AFVs).

AFVs (authorised fishing vessel) not entered on the Record are deemed not to be authorised to fish for, retain on board, tranship or land tuna and tuna-like species, and therefore are presumed to be engaging in IUU fishing. Flag States must ensure their vessels are included on the record and have certain responsibilities to control their activities in accordance with a range of requirements including legislative implementation, licensing, enforcement, vessel documents, logbooks and marking of fishing gear. These measures have been updated and strengthened in Resolutions 18/03 and 19/04 *concerning the IOTC record of vessels authorised to operate in the IOTC area of competence*.

In 2011, IOTC established an IUU Vessel List - a list of vessels presumed to have carried out IUU fishing in the IOTC Area of Competence (currently in Resolution 18/03). Criteria and procedures for listing are identified, and port-related measures and prohibitions are specified including the CPCs' obligations to:

- refuse entry into their ports by any vessel included on the IUU Vessel List, except in case of force majeure...danger or distress, unless vessels

## Port State measures

### Procedures for the implementation of the Indian ocean Tuna Commission

are allowed entry into port for the exclusive purpose of inspection and effective enforcement action;

- consider giving priority to the inspection of vessels on the IUU Vessel List, if such vessels are otherwise found in their ports;
- prohibit the import, landing or transshipment, of tuna and tuna-like species from vessels included in the IUU Vessel List.

Many resolutions have addressed information sharing with the IOTC Secretariat and other CPCs, including, the IOTC PSMR.

#### Box 10 | IOTC Resolutions that feature, complement or support port State measures

Title	Resolution	Superseded
<i>Scheme to promote compliance by non-contracting party vessels with IOTC Resolutions</i>	01/03	
<i>IOTC Programme of inspection in port</i>	02/01	05/03
<i>IOTC record of vessels authorised to operate in the IOTC area of competence</i>	07/02	13/02, 14/02, 15/04, 19/04
<i>Port State measures to prevent, deter and eliminate illegal, unreported and unregulated fishing</i>	10/11	16/11
<i>List of Vessels presumed to have carried out IUU fishing in the IOTC area of competence</i>	11/03	18/03

### 3.3. The IOTC Port State Measures Resolution

The IOTC has taken a leading role as an RFMO in adopting robust port State measures that are almost identical to those in the FAO PSMA in Resolution 10/11, which entered into force in March, 2011. As described above, this Resolution was superseded by Resolution 16/11 (*Box 11*) *On Port State Measures to Prevent, Deter and Eliminate Illegal, Unreported and Unregulated Fishing*, is attached in Appendix 1. The only change made in 2016 was to provide for an electronic port State measures (e-PSM) system, available on the IOTC website, to implement the Resolution.

An IOTC e-PSM application was developed which provided for a three years training programme to be evaluated by the Commission in 2020. The e-PSM application is described below in section 3.3.5.

As a regional measure, Resolution 16/11 is more specifically tailored to IOTC CPCs than the global provisions in the FAO Agreement and is binding on all CPCs, whether or not they are party to the PSMA. Mindful that many CPCs are also party to the PSMA and must implement its provisions as well, this document will focus on the requirements of the PSMR.

The Resolution is applied to CPCs' ports within the IOTC area of competence, but the CPCs situated outside the area must endeavour to apply it.

#### Box 11 | IOTC Port State Measures Resolution

*IOTC Resolution 16/11 on Port State Measures to Prevent, Deter and Eliminate IUU fishing entered into force on 1 March 2011 then as Resolution 10/11, and was amended in 2016 to include the e-PSM system. It is a legally binding measure that applies to all IOTC CPCs and reflects all the relevant provisions of the 2009 FAO Agreement on Port State Measures.*

## Port State measures

### Procedures for the implementation of the Indian ocean Tuna Commission

To effectively implement the IOTC PSMR, CPCs must fully understand their responsibilities and the scope of activities involved (**Box 12**). Their responsibilities involve developing relevant legislation and on-ground human and institutional capacity and establishing operational and communications systems that include interagency cooperation.

The scope of activities involve:

- fishing and fishing related activities in support of fishing;
- foreign vessels used for fishing or related activities;
- uses of port to be denied: landing, transshipping, packaging and processing of fish and for other port services including, inter alia, refueling and resupplying, maintenance and drydocking.

To ensure consistency in identifying activities, the following definitions are applicable:

- *"fishing"* is defined as searching for, attracting, locating, catching, taking or harvesting fish or any activity which can reasonably be expected to result in the attracting, locating, catching, taking or harvesting of fish;
- *"fishing related activities"* are defined as any operation in support of, or in preparation for, fishing, including the landing, packaging, processing, transshipping or transporting of fish that have not been previously landed at a port, as well as the provisioning of personnel, fuel, gear and other supplies at sea; (*the term "related activities" is used in this Manual, to indicate fishing related activities in support of IUU fishing*)
- *"illegal, unreported and unregulated fishing"* refers to the activities set out in paragraph 1 of Resolution 18/03.

The PSMR sets minimum standards for the functions of inspectors and the information to be provided in the written reports of each inspection.

CPCs must implement the IOTC PSMR in their capacity as port States and flag States, and must ensure that the responsibilities of the vessel owners, operators and agents are included in national legislation and procedures. The following sections address these various obligations.

## Box 12 | Structure of the IOTC Port State Measures Resolution

### Part 1 - General

- Definitions
- Objective
- Application
- Integration and coordination at the national level

### Part 2 - Entry into Port

- Designation of ports
- Advance request for port entry
- Port entry, authorisation or denial
- Force majeure

### Part 3 - Use of Ports

- Denial of use of port prior to inspection - criteria and procedures
- Information and communication provisions

### Part 4 - Inspections and Follow-up Actions

- Levels and priorities for inspection
- Conduct of inspections
- Results of inspection
- Transmittal of inspection results
- Training of inspectors
- Information on resource in the port State

### Part 5 - Role of flag States

### Part 6 - Requirements of developing States

### Part 7 - Duties of the IOTC Secretariat

*Note the similarities with the general structure of the FAO PSMA (Box 9).*

### **3.3.1. The responsibility of the port State in implementing the IOTC PSMR**

The port State has a range of responsibilities to implement the IOTC PSMR for all foreign vessels seeking entry into or in its ports, with certain exceptions shown in **Box 13**. The port State must therefore develop policy, legal, institutional and operational aspects at all relevant levels, as well as ensure sufficient human capacity to discharge its obligations (**Box 14**).

#### **Box 13 | Role and responsibility of the port State - application to foreign vessels**

##### *Part 1 paragraph 3:*

3.1 "Each CPC shall, in its capacity as a port State, apply this Resolution in respect of vessels not entitled to fly its flag that are seeking entry to its ports or are in one of its ports, except for:

- (a) vessels of a neighbouring State that are engaged in artisanal fishing for subsistence, provided that the port State and the flag State cooperate to ensure that such vessels do not engage in IUU fishing or fishing related activities in support of such fishing; and
- (b) container vessels that are not carrying fish or, if carrying fish, only fish that have been previously landed, provided that there are no clear grounds for suspecting that such vessels have engaged in fishing related activities in support of IUU fishing."

3.2 This Resolution shall be applied in a fair, transparent and non-discriminatory manner, consistent with international law.



The Resolution highlights six fundamental aspects that the port State must address:

**a.** *Integration and coordination at the national level*

The Resolution requires integration and coordination at the national level. This has implications for a range of aspects that include determining institutional mandates, decision-making procedures and developing human capacity and information systems. Such considerations may need to be reflected in national policies, plans, strategies as well as legislation and agreed procedures.

The PSMR requires CPCs, to the greatest extent possible, to undertake the following actions, which may be achieved through national policies, plans, strategies, legislation or procedures.

- Integrate or coordinate fisheries related port State measures with the broader system of port State controls. This would include port controls applicable to merchant vessels.
- Integrate port State measures with other measures to combat IUU fishing and related activities, taking into account as appropriate the IPOA-IUU. This would include, for example, VMS and observer programmes.
- Exchange information among relevant national agencies and coordinate their activities.

**b.** *Designation of ports*

CPCs are required to designate and publicise the ports to which foreign vessels may request entry and provide a list of these ports to the IOTC Secretariat. The IOTC will give the list due publicity on its website. Following this each CPC must, to the greatest extent possible, ensure that every port designated and publicised has sufficient capacity to conduct inspections in accordance with the Resolution.

**c. Port entry: authorisation and denial**

Each CPC must require an advance request to enter port (AREP) from all foreign fishing vessels and vessels that engage in fishing related activities. The minimum information to be submitted in the AREP is required in Annex 1 of the Resolution, but CPCs may require additional information. .

The e-PSM application described above in section 3.3 includes forms for AREPs and where needed a request for additional information (RAI) by the port State, as well as a form for notification to a fishing vessel (NFV). CPCs must require submission of the AREP at least 24 hours before entering into port, or immediately after the end of the fishing operations if the time to reach the port is less than 24 hours. For the latter, the port State must have enough time to examine the information in the AREP.

The CPC must deny port entry where there is sufficient proof of IUU fishing or related activities, in particular where a vessel is on an IUU Vessel List. However, entry into port may be allowed exclusively for inspecting the vessel and taking other appropriate actions at least as effective as denial of entry. Where entry is denied, the CPC must communicate its decision to the flag State, relevant coastal States and the IOTC Secretariat.

Where port entry is authorised, the CPC must require the vessel master or representative to present the authorisation for entry upon the vessel's arrival at port.

Nothing will prevent a CPC from permitting port entry to a vessel claiming force majeure exclusively to render assistance to persons, ships or aircraft in danger or distress. However, authorities should be mindful that State sovereignty over ports prevails and there is no obligation to allow entry to vessels making such a claim; in fact, they may be false and in some cases entry could present a threat or danger to the port State.

In order to ensure a smooth and effective process upon receiving an AREP, the request by a vessel for port entry, CPCs should ensure there is sufficient legal and procedural underpinning for:

- clear reporting and decision making procedures;
- procedures for receiving and reviewing the authorisation to enter port;
- effective procedures for communication and information exchange among relevant government agencies, and with flag States, other CPCs, IOTC and RFMOs;
- deterrent measures that can be taken against vessels that enter port where entry has been denied or where authorisations to enter have not been presented as required.

**d. Denial of use of port prior to inspection**

Similar to requirements in the FAO PSMA, the use of port must be denied in specified circumstances after entry into port, before or after inspection. They include situations where:

- a vessel has no authorisation to fish issued by the flag State;
- a vessel has no authorisation to fish issued by a coastal State for waters under its jurisdiction;
- clear evidence that the fish on board was taken in contravention of applicable requirements of a coastal State;
- a flag State does not confirm that the catch was taken in accordance with applicable requirements of an RFMO (including IOTC); and
- otherwise where there are reasonable grounds to suspect IUU fishing or related activities.

A form for requesting flag State confirmation that the catch was taken in accordance with RFMO requirements is in Appendix XII; it is also elaborated in section 6.3.7 below.

Evidence for the above situations may be discovered without inspection through external communications.

## Port State measures

### Procedures for the implementation of the Indian ocean Tuna Commission

#### e. Inspections

Levels and priorities for inspections are required: CPCs are required to inspect at least 5 percent of landings or transshipments in ports during each reporting year.

Inspections must involve the monitoring of the entire discharge or transshipment and include a cross-check between the quantities by species recorded in the prior notice of landing and the quantities by species landed or transhipped. When completed the inspector must verify and note the quantities by species of fish remaining on board.

Inspectors must avoid unduly delaying a vessel, ensure that the vessel suffers the minimum interference and inconvenience, and avoid degradation of the quality of the fish.

The port CPC may invite inspectors of other CPCs to accompany their inspectors and observe landings or transshipments of fish caught by vessels flagged to another CPC.

The functions of inspectors are in Annex 2 of the IOTC PSMR, and CPCs must ensure that they are carried out as a minimum standard. This could involve developing procedures to ensure implementation.

The CPC must ensure the following, including through legislation and procedures:

- Inspections are conducted by qualified persons authorised for that purpose, with the legal mandate and support to execute their duties.
- Prior to the inspection, inspectors present their identification to the vessel master.
- Inspectors examine all relevant areas of the vessel, fish, nets, gear, equipment, document or record relevant to verifying compliance with IOTC CMMs.
- Require the master to give inspectors assistance and information, including material/documents or certified copies.

- Where there are arrangements with the flag State, invite its participation in the inspection.
- All efforts are made to avoid unduly delaying the vessel and to minimise interference and inconvenience.
- Ensure that inspections are conducted in a fair, transparent and non-discriminatory manner that does not constitute harassment.
- There is no interference with the Master's ability to communicate with flag State authorities.

Following each inspection a written report must be completed that includes all the information set out in Annex 3. The IOTC e-PSM Application addresses the port inspection process, including examinations, findings by the inspector and apparent infringements, including reference to relevant legal instruments.

The port State CPC must then, within three full working days of the completion of the inspection, transmit by electronic means a copy of the inspection report and, upon request, an original or a certified copy thereof, to the master of the inspected vessel, the flag State and the IOTC Secretariat.

In addition and where appropriate, the report may also be sent to:

- the flag State of any vessel that transhipped catch to the inspected vessel;
- the relevant CPCs and States, including those States for which there is evidence through inspection that their vessel has engaged in IUU fishing, or fishing related activities in support of such fishing, within waters under their national jurisdiction; and
- the State of which the vessel's master is a national.

The IOTC Secretariat must without delay transmit the inspection reports to relevant RFMOs and post them on the IOTC website.

**f.** *Training of inspectors*

CPCs must ensure that its inspectors are properly trained taking into account the guidelines for the training of inspectors in Annex 5. To achieve this, CPCs should identify the human capacity needed to carry out inspections and plan for appropriate training. Cooperative mechanisms with other CPCs and IOTC for training of inspectors should be considered.

**g.** *Port State actions following inspections*

Following inspection, where there are clear grounds for believing that a vessel has engaged in IUU fishing or related activities, the inspecting CPC must

- notify the flag State and IOTC Secretariat, and as appropriate relevant coastal States, other RFMOs and the master's national State; and
- deny the use of port to the vessel if not already done.

Port services essential for the safety or health of the crew or the safety of a vessel should not be denied.

The CPCs are not prevented from taking additional measures in conformity with international law, and may take measures that the flag State has expressly requested or to which it has consented.

CPCs should consider identifying actions to take where inspections have revealed clear grounds for believing that a vessel had engaged in IUU fishing or related activities. The actions may be integrated in national legislation, procedures, policy or other and include - in addition to legislation implementing the IOTC PSM and requiring denial of the use of port - offences, fines and penalties (at punitive levels) for violations of national laws and IOTC CMMs, issuing banning orders for vessels/masters, imposing "Lacey Act" requirements prohibiting the import, sale, etc of any fish on board caught illegally in other countries' waters or in contravention of IOTC CMMs and creating offences for persons assisting a vessel where use of port or entry had been denied. Proposing the listing of the vessel on the IOTC IUU Vessel list could also be considered.

#### Box 14 | Role and responsibilities of the port State - fundamental requirements for implementing the IOTC PSMR

*The port State must implement fundamental aspects of the PSMR through legislation and procedures, including to:*

- implement legal requirements of PSM in national legislation, including;
- designating ports where foreign vessels may enter;
- requirements for port entry, including advance request, authorisation, denial of entry;
- conditions and requirements for denial of the use of port, before and after inspection;
- requirements for inspection;
- reporting and communication requirements;
- provide legal authorities and responsibilities for inspectors and authorised fisheries officers;
- appropriate requirements for evidence;
- appropriate requirements for providing information that is true, complete and correct;
- establish interagency institutional and administrative processes, including in designated ports, to assess advance requests to enter port, accept authorisations to enter port upon arrival, conduct inspections and enforce decisions;
- integrate and coordinate the implementation of the measures at national level;
- train inspectors to investigate and process requests from vessels for on board inspections.

*For a legislative template and framework for procedures, see "Implementation of Port State Measures", FAO, 2016.*

### **3.3.2. The responsibility of the flag State in implementing the IOTC PSMR**

The role and responsibilities of CPCs as flag States are described in order to promote compliance by their flag vessels with the objectives of the Resolution and the requirements of the port State CPCs, and to enhance cooperation among port and flag State CPCs to combat IUU fishing (*Box 15*). In summary, flag State CPCs:

- must require their vessels to cooperate with the port State inspections;
- where there are clear grounds to believe that one of its flag vessels has been engaged in IUU fishing or fishing related activities and is seeking entry to or is in the port of another State, they must request the port State to inspect the vessel or to take any other measures consistent with the Resolution;
- must encourage their flag vessels to land, tranship, package and process fish, and use other port services, in ports of States that are acting in accordance with the Resolution;
- are encouraged to develop fair, transparent and non-discriminatory procedures for identifying any State that may not be acting in accordance with, or in a manner consistent with, the Resolution;
- where, following a port State inspection, an inspection report is received indicating that its flag vessel has engaged in IUU fishing or fishing related activities, they must immediately and fully investigate the matter and upon sufficient evidence take enforcement action without delay in accordance with its legislation;
- must report to other CPCs, relevant port States and, as appropriate, other relevant States, RFMOs and FAO on the actions they have taken in respect of its flag vessels that, as a result of port State measures, have been determined to have engaged in IUU fishing or related activities.

Flag State CPCs must ensure (*Box 15*) that measures applied to their flag vessels are at least as effective in combating IUU fishing and related activities as measures applied to the vessels to which the Resolution applies (foreign vessels seeking entry into or in the port of a port State).



### Box 15 | Role and responsibilities of the flag State - fundamental requirements for implementing the IOTC PSMR

*The flag State must implement fundamental aspects of the PSMR through legislation and procedures, including to:*

- require their vessels to cooperate with the port State inspections;
- where there are clear grounds to believe that one of its flag vessels has been engaged in IUU fishing, they must request the port State to inspect the vessel or to take any other measures consistent with the Resolution;
- must encourage their flag vessels to use ports of States that are acting in accordance with the Resolution;
- are encouraged to develop fair, transparent and non-discriminatory procedures for identifying any State that may not be acting in accordance with, or in a manner consistent with, the Resolution;
- where, following a port State inspection, an inspection report is received indicating that its flag vessel has engaged in IUU fishing, they must immediately and fully investigate the matter and upon sufficient evidence take enforcement action without delay in accordance with its legislation;
- must report to other CPCs, relevant port States and, as appropriate, other relevant States, RFMOs and FAO on the actions they have taken in respect of its flag vessels that, as a result of port State measures, have been determined to have engaged in IUU fishing or related activities.

**For a legislative template and framework for procedures, see "Implementation of Port State Measures", FAO, 2016.**

### **3.3.3. *The responsibility of the vessel owner, operator or agent in implementing the IOTC PSMR***

The fishing industry plays an important role in compliance with requirements of the port State and flag State in implementing the IOTC PSMR their resolution as they can undermine the measures or enhance the effectiveness of the measures (*Box 16*). Vessel owners and operators, as well as the agents for vessels in the port are expected to be fully up-to-date with the content and requirements of Resolution 16/11 as implemented at national level by port States and flag States. The key requirements important for industry compliance concern reporting and inspection.

To support industry compliance, the IOTC e-PSM application includes a user guide for industry, as well as guides for port States and flag States.

In most cases the transmission of documents requesting entry into a port will be through the vessel's agents. The agents are often also best suited to provide translation services during the inspection. Concerning procedures, the fisheries authorities of a port should identify the key agents representing the foreign vessels seeking port entry, ensure they are familiar with relevant requirements and advise and encourage them to cooperate with the inspection teams.

Concerning legal matters, legislation should control the operators and agents to ensure their compliance and deter attempts to avoid responsibilities. Considering the nature of some operators and agents to avoid compliance, robust provisions should be enacted that control the appointment and operation of agents, including prohibition of conflict of interests.

Offences must be created in relation to operators and agents with the possibility of punitive fines and penalties for failure to comply with the range of requirements to implement the IOTC PSMR such as timely submission of full information, providing information promptly on request that is true, correct and complete, production of authorisations upon port entry, compliance with inspections, compliance with denial of port use and other.

### Box 16 | Role and responsibilities of the fishing industry

*The implementation of the PSM Resolution involves fundamental requirements with which the fishing industry must comply:*

- before entering port the master or the agent of the vessel must provide the advance request for entry into port to the appropriate authorities within the required time frame and with true, correct and complete information;
- in case of authorisation of entry, the master or agent of the vessel must, upon the vessel's entry into port, present the authorisation for entry to the appropriate authorities;
- cooperate with the Port State during the inspection of the vessel and be aware of the inspection procedures, give inspectors all necessary assistance and information, and present relevant material and documents;
- comply with all requirements under relevant port State legislation.

### **3.3.4. The responsibility of the IOTC Secretariat in implementing the IOTC PSMR**

The IOTC Secretariat is responsible for posting without delay on the IOTC website the following information:

- the list of designated ports;
- the prior notification periods established by each CPC;
- the information about the designated competent authority in each port State CPC;
- the blank copy of the IOTC Port inspection report form.

The Secretariat is also responsible for posting without delay on the secure part of the IOTC website copies of all port inspection reports transmitted by port State CPCs (*Box 17*). The Secretariat must post all forms related to a specific landing or transshipment together.

## Port State measures

### Procedures for the implementation of the Indian ocean Tuna Commission

In addition, the Secretariat must, without delay, transmit the inspection reports to the relevant RFMOs.

#### Box 17 | Duties of the IOTC Secretariat

*The IOTC PSMR requires the IOTC Secretariat to:*

- post on the IOTC web site:
  - the list of designated ports;
  - the competent authority in each port State CPC;
  - the prior notification period established by each CPC;
  - on a secure part of the website, the copies of all port inspection reports transmitted by port State CPCs, including all forms related to a specific landing or transshipment;
- transmit the inspection reports to the relevant RFMOs.

### 3.3.5. The IOTC e-PSM application

In 2016 the IOTC PSMR was amended to introduce a paragraph on a new e-PSM system. It provided that CPCs may use the system, available via the IOTC website, to implement the PSMR. A trial period of three years from 2016 was foreseen to allow for the delivery of a complete training programme and further improvement and development.

CPCs were called upon to encourage all stakeholders (vessel representatives, port States and flag States) to utilise, to the greatest extent possible, the e-PSM application to comply with the PSMR and provide feedback and inputs contributing to its development until 1 January 2020. The success of the application was to be evaluated at the sixteenth session of the Compliance Committee and consideration shall be given to making its use mandatory and defining a period for implementation.

After that date the possibility to submit an advance request for port entry manually in accordance with Article 6 would remain, should access to the Internet not be possible for any reason.

Made of three independent modules, the e-PSM application has been designed and developed to facilitate and assist the IOTC CPCs to implement the IOTC PSMR and related Resolutions. Information is at <https://iotc.org/compliance/port-state-measures>.

### **Module 1: e-PSM Forms and Processes**

The first module, e-PSM forms and processes, is a working and communication platform for the fishing industry, the port States CPCs, the flag State CPCs to implement their responsibilities in terms of the IOTC PSMR. As the first step of the PSM process, this module allows the fishing industry to submit electronically to port State CPCs an advance request for entry into port (AREP) to decide whether to authorise or deny the entry of the vessel into its port and communicate this decision to the vessel or to its representative.

### **Module 2: e-PSM Library**

The second module, e-PSM library, is an information sharing platform to IOTC CPCs where PSM related information can be found, including the following:

- information on designated ports, designated competent authority in each port State CPC and prior notification period established by each CPC;
- e-PSM application user manuals (Industry manual, port State CPCs manual and flag State CPCs manual);
- PSM forms created in the Module 1: Advance Request of Entry into Port (AREP) and Port Inspection Reports (PIR) (Restricted access);
- documents, technical reports, meeting reports, video on various fisheries topics (e.g. tuna fisheries management, fisheries Monitoring Control and Surveillance (MCS) and port State measures, etc.);
- internet link to useful internet resources (e.g. vessel movement information, port information, etc.).

– Background to the development of port State measures –

### **Module 3: e-PSM Reporting**

The third module, e-PSM reporting, is a reports-building tool where CPCs can generate reports related to the activities of foreign vessels in its port or activities of its flagged vessels in foreign ports.

This module allows CPCs to generate the mandatory report required by Resolution 05/03 (Details of landing of foreign vessels in ports), as well as the mandatory report required by Resolution 18/06 (Details of transshipments of flag vessels in foreign ports).

#### **e-PSM manuals**

User Manuals have been produced for:

- vessel representatives (Agents, Masters, Owners, Operators, Beneficial owners);
- port State competent authority;
- flag State competent authority;
- non-flag State and non-port State users.

They are essential documentation for proper use of the e-PSM application.

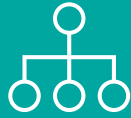

## CHAPTER 2



# OPERATIONAL AND TECHNICAL INFORMATION

## **A**quiring the knowledge to implement the IOTC Port State Measures

---

- Inspector appointment and training, powers of fisheries inspectors
- Ethics, confidentiality of information, health and safety on board
- Fish and product identification, fishing gear design and specifications
- Vessel Monitoring Systems.

*This chapter provides background for several of the training requirements in Annex 5 of the IOTC PSMR. It will enable inspectors to understand the protocols required to approach vessel personnel and conduct inspections on board fishing vessels from different countries and appreciate and address potential challenges and dangers on board vessels when they are executing their functions.*

*The first section of this chapter deals with the appointment and ethical protocols expected from inspectors. This is followed by requirements for health and safety training, which should be mandatory for all persons having to conduct on board inspections.*

*The following sections covering fish product identification, fishing gear, navigation equipment, position recording and vessel monitoring systems (VMS) serve to provide inspectors with a basis in understanding the fisheries, species caught and fishing gear they are likely to encounter as well as the technical knowledge needed for collecting evidence on vessel position and activities.*

*The powers of an inspector to conduct inspections and collect evidence for further judicial or administrative processes are discussed. They should comply with requirements and standards at national level and those that appear in relevant IOTC CMMs.*



# 4

## Inspector appointment and training

### 4.1.

Ethics and confidentiality  
of information

---

### 4.2.

Health and safety  
on board

---

### 4.3.

Fish and product  
identification

---

### 4.4.

Fishing gear design  
and specifications

---

### 4.5.

Navigation equipment

---

### 4.6.

Vessel Monitoring Systems

---

### 4.7.

Powers of fisheries inspectors

---



**T**he appointment and powers of fisheries inspectors are provided in national fisheries legislation, giving inspectors a legal mandate to inspect and, as appropriate, enforce all relevant legislation. Fisheries inspectors perform duties that stem from the sovereignty of their country, including over ports. Their role in relation to port State measures is to support implementation of by inspecting on board foreign fishing vessels seeking entry to or in their ports. They represent the fisheries authority and, on board foreign fishing vessels, their country.

---

In carrying out inspections in its ports the CPC must ensure that inspections are carried out by properly qualified inspectors authorised for that purpose, and that its inspectors are properly trained taking into account the guidelines for training inspectors in Annex 5 of the IOTC PSMR. Annex 5 provides that elements of a training programme should include at least the following areas, most of which are elaborated in this manual.

- a. Ethics.
- b. Health, safety and security issues.
- c. Applicable national laws and regulations, areas of competence and conservation and management resolutions of the IOTC, and applicable international law.
- d. Collection, evaluation and preservation of evidence.
- e. General inspection procedures such as report writing and interview techniques.
- f. Analysis of information, such as logbooks, electronic documentation and vessel history (name, ownership and flag State), required for the validation of information given by the master of the vessel.
- g. Vessel boarding and inspection, including hold inspections and calculation of vessel hold volumes.
- h. Verification and validation of information related to landings, transshipments, processing and fish remaining on board, including utilising conversion factors for the various species and products.

- i. Identification of fish species, and the measurement of length and other biological parameters.
- j. Identification of vessels and gear, and techniques for the inspection and measurement of gear.
- k. Equipment and operation of VMS and other electronic tracking systems.
- l. Actions to be taken following an inspection.

## **4.1. Ethics and confidentiality of information**

### **4.1.1. Professional conduct**

#### **The Spirit of boarding**

Although there are fully legal grounds for carrying out inspection of fishing vessels in port, the attitude or spirit of the boarding will have a major influence on both the reception on board the fishing vessel, and the results and value of the subsequent inspection. The most important factor for the inspection team is to be even-handed and professional throughout the event. If the master of the fishing vessel feels that he is dealing with professionals, he will be less likely to try to deceive or obstruct the inspectors.

#### **Professionalism**

Fisheries inspectors must always conduct themselves in a courteous, polite and professional manner with all members of the crew, keeping in mind that while he or she is a fishery inspector, a representative of the fisheries authority and in the case of a foreign vessel, a representative of his or her country (*Box 18*).

It is important to avoid personal involvement in discussions with persons on board the vessel and to avoid expressing a personal opinion on fisheries regulations, procedures and policies. These can undermine the authority of the inspection team and hence the effectiveness of the inspection process.

It is a common occurrence for the master of foreign vessels to offer some type of gift to officials when boarding their vessels. This often involves the offer of drinks, including alcoholic beverages. Refusal of these can also be perceived as an insult in some cases. States should have clear procedures on how to deal with these occurrences in accordance with their particular customs and culture.

The cultural customs of crews on foreign fishing vessels will vary from country to country and in many instances crews may have been at sea for many months at a time. It is both professional and courteous to respect their customs. A common practice is to remove shoes when entering a wheelhouse or the living quarters on a vessel. It is important to not comment on pets or pictures displayed in the vessel. On some vessels a small shrine may be situated on the bridge or in the chart room, do not tamper with these.

## Port State measures

### Procedures for the implementation of the Indian ocean Tuna Commission

#### Box 18 | Inspection of fishing vessels - Professional conduct

- Smart, uniform dress of inspectors throughout including no smoking or eating while on duty.
- Efficient embarkation on board inspected vessel.
- Polite but firm conduct of initial interview of master.
- Polite but firm treatment of crew members throughout inspection.
- No sitting down, leaning or slouching during the inspection.
- A 'matter of fact' but firm approach to the inspection of the vessel. Nothing should be given away until evidence of an offence is firmly established. Questions should be 'open' to crew members with all replies accurately noted. Not to accept any beverage for immediate consumption or any alcoholic gifts.
- Despite insistence on the part of the crew or officers for inspectors to accept gifts of fish or any other type of gift offered during or after the inspection, the inspector must politely refuse these, taking care as far as possible to not cause offence.
- The last point is often assisted by a standard notice, letter or card carried by the inspector noting that Ministry policy is that inspectors must 'not accept' any offer of a gift, fish or beverages by the master or crew. Such acceptance may constitute grounds for dismissal from the Inspection Service.

## 4.1.2. Uniforms and appearance

Uniforms are important to identify the inspector as a professional representative of their country and to separate them from other people that may be boarding the vessel such as chandlers, mechanics and technicians, among others. Uniforms therefore should be kept clean, well pressed and neat (*Figure 23*) worn in full and not in parts. Proper dress uniform consists of pants, shirt, hat, and shoes provided by the fisheries authority.

The most important first action is for the port inspectors to present him/herself to the master of the vessel. Identity cards or badge are to be shown at the outset. The port inspector must ensure that the master and the crew understand that you are a fisheries inspector and that you are on duty, and make sure of your authority in the circumstances. It is important to remember that being *in the execution of one's duty* implies much more than being on duty. It means that you are authorised in law to conduct the inspection and that you are granted the powers to do what you are doing.



*Figure 23: Fisheries inspector completing the port inspection report on board a vessel*

### 4.1.3. Confidentiality of information

A code of classification and access to information should be an integral part of fisheries management policies. All information collected on board a vessel must be treated in the strictest confidence. Do not share any information (especially catch information) with other officials that may be on board and never discuss particulars of other vessels with any of the personal on board. Breach of confidentiality of information should be noted in the Code of Conduct for Fishery Inspectors and be subject to disciplinary procedures, including up to dismissal from the service.

## 4.2. Health and safety on board

When boarding vessels alongside the quay or in the vicinity of the port, inspectors must be well prepared and anticipate unexpected occurrences. The primary objective of health and safety training is to ensure that inspectors are equipped with the necessary skills and awareness to safely perform their duties (Figure 24). The training aims to cultivate an attitude and commitment to safe working practices that will lead to a heightened awareness of safety issues and thus reduce the risk of accidents and injury while on board a vessel.

Health and safety on board is the responsibility of each individual, not only for personal safety but also for the safety of others and the vessel. It is the duty of all individuals to bring to the attention of the master or the Health and Safety Officer designated on board any perceived dangers to individuals or the vessel.



© IOTC

*Figure 24: Wearing hard hat is mandatory during offloading operation*



There are many aspects to health and safety and knowledge of these is developed with experience at sea. Although vessels are different in design and function, common health and safety risks are given below (**Box 19**).

- Improperly stowed equipment.
- Oil on ladders and decks. This can cause falls and injuries.
- Smoking in unauthorised places. This can cause fires and explosions.
- Incorrect safety clothing, leading to serious personal injury.
- Radiation Hazards (RADHAZ) emitting from radio, radar and laser transmitters. These are normally marked with circles on the deck into which crewmembers should not enter while the transmitter is on.
- Going up the mast without permission. This can result in radiation burns and physical injury from rotating radars.

#### Box 19 | Inspection of fishing vessels - Common risks on board vessels

- Un-safe boarding and danger of falling between quay and vessel
- Fish or cartons falling from overhead hoists
- Crane hooks swinging overhead
- Falling into open hatches
- Slippery deck
- Cables on the deck snatching up under tension from winches being started up
- Poorly stored fishing gear creating hazardous footing on or below decks;
- Refrigeration gas leakage

## Port State measures

Procedures for the implementation of the Indian ocean Tuna Commission

Health and safety training involves two broad categories: protective clothing and safety procedures, described below (*Box 19*).

### 4.2.1. Protective clothing

Protective clothing helps to prevent injury but does not prevent accidents from happening. These can only be reduced through awareness and an attitude respectful of safe working practices. Protective clothing includes those indicated in *Figure 25*.



Figure 25: Important protective clothes for the conduct of inspection in port

There is always the danger of objects falling or being knocked over when moving around in the narrow confines of a vessel. Boots with steel toecaps and ankle protection and "hard hats" help to prevent injury from these risks. In some harbours it is now mandatory for these items to be worn when working on deck or monitoring off-loading ashore. Good quality safety boots should also have non-slip soles that are not affected by chemicals and assist with traction on wet and slippery decks. However, it is essential to respect cultural practices on board foreign vessels where shoes are not worn on the bridge or in the living quarters.

A safety helmet or "hard hat" must be worn at all times when moving around on the upper deck of a vessel or monitoring off-loading. When going between decks the helmet can be replaced with a soft cap that will assist in protecting your head when moving around narrow passageways with low bulkheads.

In harbours where fishing vessels do not dock alongside the quay but remain at anchor within port limits, the inspection party will have to embark from a harbour launch. Despite operating in protected conditions, there are dangers similar to boarding at sea. A PFD should be worn during the boarding operation and while moving around on the upper deck.

Similar to the requirement for safety boots and hard hats, wearing a reflective jacket is compulsory in many harbours. The reflective jacket assists in making the inspector more visible, especially in low light conditions. It enhances the visibility of the inspector to crane or machinery operators.

Working gloves are useful to protect the hands from sharp objects and also to keep hands clean when inspecting and handling gear on board.

Freezer suits and gloves are essential for going into freezer holds and handling frozen products. At temperatures below minus 50° C freezer burns can occur instantly from casual brushing against metal items in a freezer hold and longer exposure can have serious long-term after-effects.

### 4.2.2. Safe working practices

Once on board, an inspector must quickly familiarise himself with the layout of the vessel and potential health and safety risks. A health and safety tour could be conducted by one of the officers, should the inspector consider it necessary. This will be essential on a vessel the inspectors are not familiar with, a reefer for example, where hatches are open and transshipping or brailing operations are on-going overhead (*Figure 26 & Figure 27*).



© IOTC



© IOTC

*Figure 26: Brailing operations on a purse seiner*



© IOTC



© IOTC

*Figure 27: Tunas are being conveyed to the wells located at the lower deck of a purse seiner*

### 4.2.3. Procedure for entering enclosed spaces

A number of dangers exist when entering enclosed spaces and it is essential that inspectors are both aware and trained to undertake inspections in these areas. All inspections of enclosed spaces must have an inspection party of a minimum of two people (*Figure 28*). Both must be officials of the port State and at no stage should crew members be used as an alternative to accompany a single inspector.

The two main dangers are low oxygen levels and being inadvertently locked in. The atmosphere in enclosed spaces without ventilation can result in low oxygen levels. This is often exacerbated in hot calm conditions. In freezer holds contamination from refrigeration gasses also poses a high risk.

Routine procedures for entering enclosed spaces are described below.

- Open hatches slowly and make sure the hatch is locked open. Inspectors may want to make special provision for this and one of the inspection party **MUST** monitor the open hatch at all times.
- All enclosed compartments must be well ventilated before entering.
- Shine a torch into the compartment if there is no lighting, and check for obstructions.
- If it is evident that the compartment has been closed for some time without ventilation (quite likely if there is no lighting), then arrange for the area to be ventilated. In an extreme situation artificial breathing apparatus would have to be used to enter the space.



© IOTC

*Figure 28: Inspection of a well on board a longliner*

## Port State measures

### Procedures for the implementation of the Indian ocean Tuna Commission

- In the event of a single inspector going into a compartment, he or she must wear a safety harness and lifeline controlled by the person at the open hatch. Under no circumstances must the inspector monitoring the open hatch or any other person enter the space unless breathing apparatus is available. The lifeline should be used instead.

### 4.3. Fish and product identification

The four main target tuna species in the Indian Ocean region are yellowfin (*Thunnus albacares*), bigeye (*Thunnus obesus*), albacore (*Thunnus alalunga*) and skipjack tuna (*Katsuwonus pelamis*) (Table 2). Southern bluefin tuna (*Thunnus maccoyii*) are caught in southern temperate zone and are managed throughout its distribution by the Commission for the Conservation of Southern Bluefin Tuna.

It is important for port inspectors to be able to identify the main species caught in the Indian Ocean region, both in their whole and processed states.

A complete identification species guide is provided in the port inspector tool kit.

*Table 2 - Principal fish species caught in the Indian Ocean region*

FAO Species Code	Common name (English)	Scientific Name
Target species		
YFT	Yellowfin tuna	<i>Thunnus albacares</i>
BET	Bigeye tuna	<i>Thunnus obesus</i>
SBF	Southern bluefin tuna	<i>Thunnus maccoyii</i>
SKJ	Skipjack tuna	<i>Katsuwonus pelamis</i>
ALB	Albacore or longfin tuna	<i>Thunnus alalunga</i>
Common bycatch species		
KAW	Kawakawa	<i>Euthynnus affinis</i>
SWO	Swordfish	<i>Xiphias gladius</i>
BUM	Blue marlin	<i>Makaira mazara</i>
BLM	Black marlin	<i>Makaira indica</i>
MLS	Striped marlin	<i>Tetrapturus audax</i>
SFA	Sailfish	<i>Istiophorus platypterus</i>
BSH	Blue shark	<i>Prionace glauca</i>
SMA	Shortfin mako shark	<i>Isurus Oxyrinchus</i>
PTH	Pelagic thresher shark	<i>Alopias pelagicus</i>
BTS	Big eye thresher shark	<i>Alopias superciliosus</i>
OCS	Oceanic white tip shark	<i>Carcharhinus longimanus</i>
FAL	Silky shark	<i>Carcharhinus falciformis</i>
TIG	Tiger shark	<i>Galeocerdo cuvier</i>
SPZ	Smooth hammerhead shark	<i>Sphyrna zygaena</i>
DOL	Dorado/dolphinfish	<i>Coryphaena hippurus</i>
LEC	Black escolar/smooth skin oilfish	<i>Lepidocybium flavobrunneum</i>
OIL	Escolar/ rough skin oilfish	<i>Ruvettus prestiosus</i>

## Port State measures

### Procedures for the implementation of the Indian ocean Tuna Commission

Confusion is often caused in the use of different common names of fish species by different nationalities. For example, *Thunnus alalunga* are called albacora by Spanish fishermen and *Thunnus albacares* are called albacore by French fishermen (**Table 3**). Port inspectors must crosscheck and verify catches back to their scientific names when conducting inspections, checking logbooks, recording catches and monitoring landings or transshipments.

**Table 3 - Comparative common names of the main species caught in the Indian Ocean region**

Scientific name	Common names			
	English	Japanese	Spanish	French
<i>Thunnus albacares</i>	Yellowfin tuna	Kiwada or maguro	Rabil	Albacore
<i>Thunnus obesus</i>	Bigeye tuna	Mebachi	Patudo	Thon obèse patudo
<i>Thunnus alalunga</i>	Albacore tuna or longfin tuna	Binnaga	Albacora or Atún blanco	Germon
<i>Euthynnus affinis</i>	Kawakawa	Suma	Bacoreta oriental	Thonine
<i>Katsuwonus pelamis</i>	Skipjack tuna	Katsuo	Listado or Barrilete	Bonite à ventre rayé

Identifying fresh species is relatively easy compared to distinguishing frozen or iced fish. Even at small sizes, freshly caught species have distinct coloration, body markings and body morphologies that provide rapid visual keys to positive identification (**Figure 29** & **Figure 30**). Frozen species are far more difficult to distinguish due to fin damage, discoloration, skin abrasion and distortion or crushing during the storage process.



Even though tunas are easiest to distinguish in fresh condition, misidentifications and lumping of yellowfin, bigeye and longfin commonly occurs in surface fisheries.

The following identity guide (Figure 30) should serve as a "best case" scenario for identifying the tuna target species tuna at all sizes (yellowfin, bigeye, longfin and skipjack). These examples can then be used to help differentiate samples that are in a less optimal condition.



**Figure 29:** Yellowfin tuna and bigeye tuna in fresh condition

## Port State measures

### Procedures for the implementation of the Indian ocean Tuna Commission

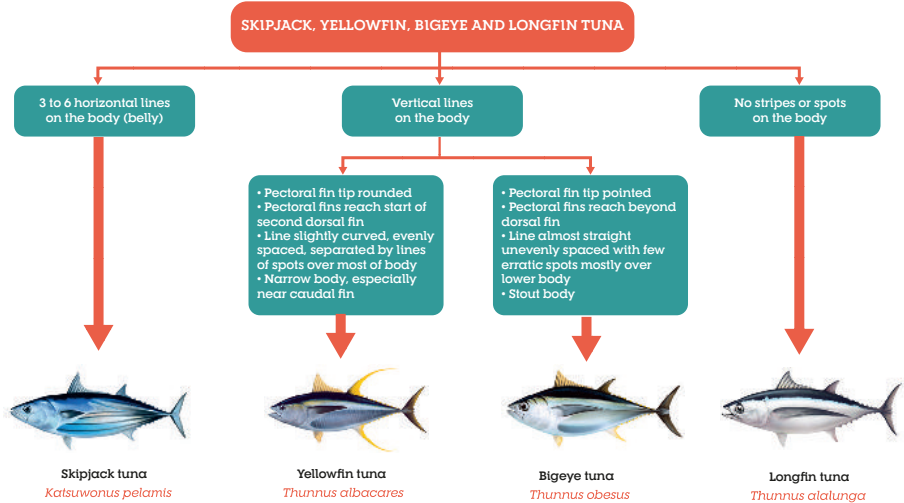





Source: IOTC, 2021

Figure 30: Identification features of the four main tunas species caught by purse seine, pole and line and longline vessels

### 4.3.1. On board fish processing and preservation

Processing that entails removing the head, tail and fins makes it difficult to distinguish between the larger tuna species and other diagnostic features are used to identify the species such as stomach lining and trunk shape. Frozen fillets are also difficult to relate to a species without knowledge of the standard processing methods used for the various species. [Table 4](#), [Table 5](#) and [Table 6](#), list the main processing methods and on board preservation codes used in IOTC statistical data reporting (Source: IOTC secretariat status report 2001 and IOTC 2005 Guidelines for the reporting of fisheries statistics to the IOTC).





*Table 4 - Types of on board fish processing codes used in IOTC*



IOTC code	Processing codes used in IOTC fisheries	Images
<b>NO/RND</b>	Unprocessed Small tuna, tuna-like and shark bycatch are commonly not processed	
<b>DR</b>	Dressed (gilled and gutted, headed, tailed and/or fins-off)	
<b>HP</b>	Highly processed (canned tuna, fish loins, fish fillets, fish meat, fish oil, smoked fish, dried fish)	
<b>SF</b>	Fins (sharks)	
<b>PR</b>	Processed (unspecified)	

## Port State measures

Procedures for the implementation of the Indian ocean Tuna Commission

Table 5 - Types of on-board fish processing codes used in IOTC

Code	Processing codes used in IOTC fisheries	
<b>WHO</b>	Whole/rounded - Not processed	
<b>GGO</b>	Head on, Gilled & Gutted, Tail on	
<b>GGT</b>	Head on, Gilled & Gutted, Tail off	
<b>HAG</b>	Head off, Gilled & Gutted, Tail on	
<b>HGT</b>	Head off, Gilled & Gutted, Tail off	
<b>GGOs</b>	Head on, Gilled & Gutted, Tail on with fins attached (for sharks)	<b>Rare</b>

Code	Processing codes used in IOTC fisheries	
<b>GGTs</b>	Head on, Gilled & Gutted, Tail off, with fins attached (for sharks)	
<b>HAGs</b>	Head off, Gilled & Gutted, Tail on, with fins attached (for sharks)	<b>Rare</b>
<b>HGTs</b>	Head off, Gilled & Gutted, Tail off, with fins attached (for sharks)	<b>Rare</b>
<b>LON</b>	Loins	
<b>FLT</b>	Fillet	
<b>BEM</b>	Belly meat	

## Port State measures

Procedures for the implementation of the Indian ocean Tuna Commission

Code	Processing codes used in IOTC fisheries	
<b>SF</b>	Shark Fins	
<b>ROE</b>	Eggs	
<b>STO</b>	Stomach	
<b>OTH</b>	Not elsewhere identified	<b>Rare</b>

*Table 6 - Types of on board fish preservation used in IOTC*

IOTC code	On board fish preservation description
NO	None
ST	Salt
DR	Dried
SM	Smoked
IC	Ice
BR	Refrigerated brine
RW	Refrigerated sea water
FR	Cold storage (Between 0 and -30 degree)
DF	Cold storage (Below -30 degree)

### **4.3.2. Conversion factors**

It is important to note that reports of catches to RFMOs are normally the live wet weight of the fish as it comes out of the water. Therefore, it is essential that inspectors are able to recognise the processing form by species, note it and convert the weight of the processed fish back to its live wet weight to be able to accurately verify catch reports and logbooks. Failure to do the conversion back to live wet weights and check with the logbook data can result in mis-reporting of the 'real' fish catches in the area. This is why it is imperative for inspectors to fully understand the importance of converting the processed weight back to live wet weight of fish catches to cross check harvesting levels by species by the vessels.

A conversion factor (or raising factor) is used to calculate the live weight of a fish from its product weight, (live weight is also termed; green weight or nominal weight). Depending of the processing method different conversion factors will be applicable for different products.

## Port State measures

### Procedures for the implementation of the Indian ocean Tuna Commission

#### Box 20 | Determination of conversion factor of a yellow fin tuna

A fresh unprocessed tuna weighs 75 kg. The fish is then processed by cutting out the gills and stomach and the fins and tail are cut off. The processed trunk is then re-weighed and found to be 68.81 kg.

The Conversion Factor (CF) is calculated by dividing the Live Weight (RND) by Processed weight (GGT).

$$CF = \text{Live Weight} / \text{Processed Weight}$$

Conversion factors for different tunas, sharks and other bycatch species are shown in [Table 7](#), [Table 8](#), and [Table 9](#) (Source: IOTC 2005 Biological data on tuna-like species gathered at the IOTC Secretariat: Status Report) and examples given in [Box 20](#) and [Box 21](#). These will have to be applied to product weights declared on board to crosscheck the catch weights reported in daily catch logs.

#### Box 21 | Using conversion factor to calculate live weight

80 tonnes of bigeye tuna are offloaded from a longline vessel.

→ The vessel log records approximately 88 tonnes.

→ The live weight is the processed weight multiplied by the conversion or raising factor.

$$\text{Live Weight} = 80 \times 1.09 = 87.2 \text{ tonnes}$$



=



x 1,09

*This figure verifies the vessels catch log recorded at 88 tonnes.*

Note that for the same species, different conversion factors may also apply. Factors to convert from processed to live weight have been published by the FAO (1992) and ICCAT.



During the unloading process inspectors will mostly encounter processed products and will have to apply the standard conversion or raising factors to calculate the live catch weights to compare to catch data.

*Table 7 - Conversion factors and processing code for target species*

Species	Common name	Processing	Raising Factor
YFT	Yellowfin tuna	GGT	1.09
		HDD	1.43
BET	Bigeye tuna	GGT	1.09
		HDD	1.43
SBF	Southern bluefin tuna	GGT	1.15
		HDD	1.43
ALB	Albacore [longfin tuna]	GGT	1.1
SKJ	Skipjack tuna	GGT	1.09

*Table 8 - Conversion factors and processing code for shark species*

Species	Common name	Processing	Raising Factor
BLS	Black Shark (Silky shark)	HDD	1.33
BSH	Blue shark	HDD	1.33
		GGT	1.13
BTS	Bigeye Thresher shark	GGT	1.13
FAL	Silky shark (black shark)	HDD	1.33
		TAL	1.55
		GGT	1.13
MSK	Mackerel sharks, Porbeagles, White sharks	HDD	1.33
		PDD	1.55
SKH	Sharks nei	TAL	1.55
		GGT	1.13
		HDD	1.33
SPY	Hammerhead sharks	HDD	1.33
THR	Thresher sharks nei	HDD	1.33
TIG	Tiger shark	HDD	1.33

## Port State measures

Procedures for the implementation of the Indian ocean Tuna Commission

*Table 9 - Conversion factors and processing code for bycatch species*

Species	Common name	Processing	Raising Factor
BIL	Billfish	GGT	1.33
		TAL	1.43
BLM	Black Marlin (White marlin; WM)	GGT	1.33
		TAL	1.43
BLZ	Indo-Pacific Blue Marlin (BUM)	GGT	1.13
		TAL	1.43
MLS	Striped Marlin	GGT	1.13
		TAL	1.2
SFA	Indo-Pacific sailfish	HDD	1.33
		GGT	1.13
		TAL	1.43
LEC	Black Escolar	HDD	1.33
OIL	Oilfish	HDD	1.33
		GGT	1.13
SSD	Shortnose spurdog	HDD	1.33
SSP	Shortbill spearfish	HDD	1.43
SWO	Swordfish	HDD	1.33
		GGT	1.18
		TAL	1.43
WAH	Wahoo	HDD	1.33
		GGT	1.13
BILL	Billfish nei	GGT	1.13
		PDD	1.43
MARL	Marlins nei	GGT	1.13
		TAL	1.43

*Table 8* is especially important to enable the inspector to cross check the weight of fins against carcass weights on board for compliance purposes (Resolution 17/05 regarding 5 percent limits). It is noted that the IOTC resolution is a bit weak with respect to weights of detached fins and carcasses, but if cleaned up to convert all weights back to live wet weights, this would further reduce the level of shark by catches in the Indian Ocean.

## **4.4. Fishing gear design and specifications**

Inspectors are likely to encounter a range of different fishing gears during port inspections that include gear not necessarily used within the immediate region. Depending on the vessel type and the fishery it is active in, accessibility to the gear to identify and measure can vary.

Items such as radio buoys, line or net haulers and net drums that are more conspicuous and fixed in place should be easy to access and identify, however much of the gear will be packed away or covered and inspectors may not find these gear components easy to identify or measure.

The Advance Request to Enter Port (AREP) includes listing the fishing gear on board. The authorisation to fish issued to the vessel by its flag State and/or licence issued by a coastal State will also specify the gear type the vessel may use. The inspection team will be required to cross check this information and inspect the gear to verify it is the same as has been authorised and if it has been used recently. Should gear be found that has not been declared or authorised, together with evidence of recent use, it may constitute evidence that the vessel has been engaged in IUU fishing.

### **4.4.1. Primary fishing gear used in the Indian Ocean region**

Fishing vessels calling into ports in the Indian Ocean region can originate from a broad area, both within and outside the Indian Ocean region and having deployed a variety of different fishing gear (*Figure 31*). However, it is most likely that the majority of the vessels (*Figure 32 & Figure 33*) will be from fleets fishing in the IOTC region targeting tuna and tuna like species. The four main industrial fishing gears involved in these fisheries are shown below.

## Port State measures

Procedures for the implementation of the Indian ocean Tuna Commission

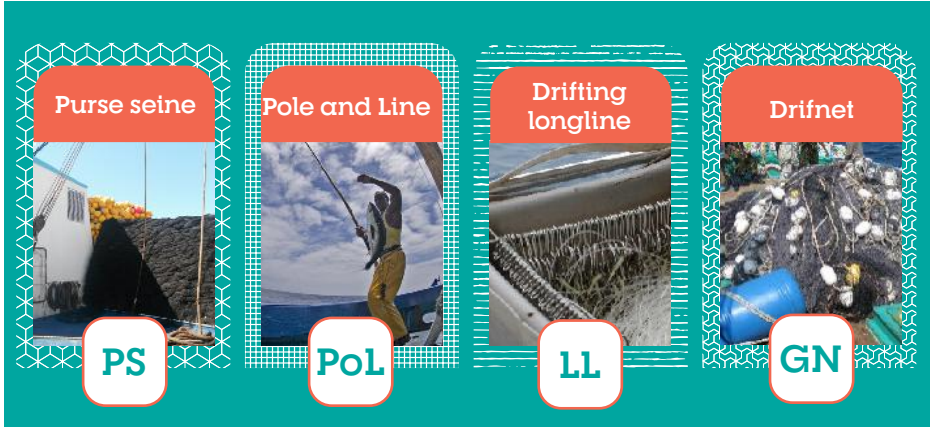

Source: IOTC, 2021

Figure 31: The primary fishing gears used in IOTC fisheries: Purse Seine (PS), Pole and line (PoL), drifting longline (LL) and Gillnet (GN)

Associated gear such as Fish Aggregating Devices (FADs) and sonar buoys will also sometimes be found on both fishing and support vessels (Figure 32 & Figure 33).



© IOTC



© IOTC

Figure 32: FAD buoys stored on upper deck of a purse seiner

Figure 33: Setting of a drifting FAD by a purse seiner

Other fisheries that are regionally based or where vessels come from places outside the IOTC Area can use the following gear:

- demersal trawl for prawn and finfish;
- demersal longline;
- mid-water trawl;
- demersal gillnets.

Inspectors should have a good understanding of how these gears are used and be able to identify and record the specifications of the different gear components. Detailed descriptions of these fishing gears are provided in *Table 10* and Appendix 11.

#### **4.4.2. Pelagic longline**

A drifting longline or pelagic longline consists of a mainline that is held near the surface or at a certain depth by means of regularly spaced surface buoys or floats (*Figure 34*). Branch lines, (also known as droppers, snoods or ganglions) with baited hooks are suspended from the main line at regular intervals between the buoys. The entire line can extend from 20 km to over 120 km.

## Port State measures

Procedures for the implementation of the Indian ocean Tuna Commission

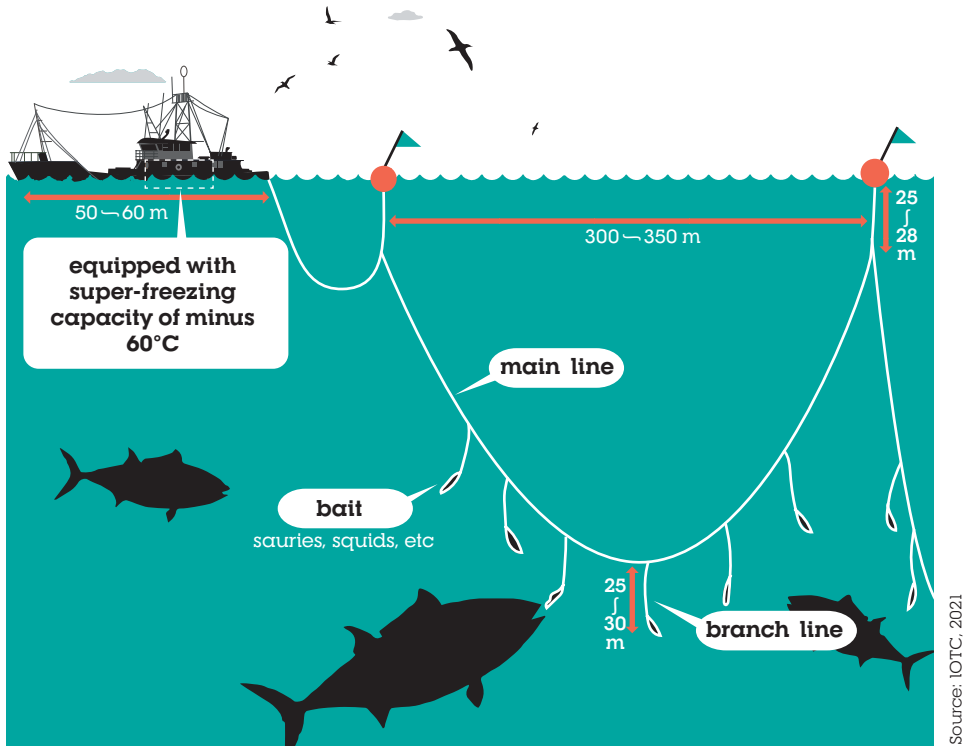

Source: IOTC, 2021

Figure 34: Main components of a drifting longline

### 4.4.3. Industrial tuna purse seine

Tuna purse-seining is an active fishing technique that involves surrounding a school of fish close to the surface with a seine net. The net is then pursed (closed off) along its bottom edge impounding the fish. When the net is hauled back on board the fish are concentrated into the "bunt" of the net and are then brailled out. The period from deployment of the net until the net is recovered on board is called a set.

The purse seine net (*Figure 35*) can measure 1,500 to 2,000 m long and 120 to 250 m deep. The top line is buoyed up to keep the top of the net on the surface and a chain or lead weights are attached to the bottom of the net to weigh it down. Steel rings (purse rings) are attached to the chain and a steel cable (purse line) feeds through the rings. The steel cable can be pulled in to close or "purse" the net from below. When not in use, the net is stacked up on the stern of the vessel ready to be set and is clearly visible. A small, powerful boat (skiff) is used to assist in setting the net around a school of fish and is hauled up astern of the net. A hydraulic power block attached to the end of a long boom is used to haul the net back and restack it in the net bin ready for the next set.



© IOTC

*Figure 35: Oceanic tuna seiner in fishing operation in the Indian Ocean*

#### 4.4.4. Pole and line

Pole and line fishing (*Figure 36*) targets surface schools of fish similar to those caught by a purse seine vessel. The gear consists of a pole with a short line attached. Poles are made of wood (including bamboo, also constructed of split cane) and increasingly of fiberglass. In industrial fisheries, "Pole and Line vessels" fishing for tuna can range from 15 to almost 40 meters in length with special arrangement for using as many poles as possible from the side of the boat and for keeping bait on board, in the best condition, if possible alive. The fish holds are divided up into a main central hold and smaller holds or tanks. The main hold is used to preserve the catch and is usually refrigerated on the larger vessels. Smaller vessels may use ice to preserve the catch on shorter trips.



*Figure 36: Pole and line fishing vessel in fishing operation in the Indian Ocean*



#### 4.4.5. Gillnet

Driftnets or gillnets (*Figure 37 & Figure 38*) consist of a series of net panels that are suspended in the water column. It is a passive method of fishing that does not use bait or actively trap fish. The fish swim into the net and become entangled. Gillnets can be broadly classified into three categories: set nets (anchored), drift nets and trammel nets.

Gillnets are generally made up of a series of panels with a weighted "foot-rope" attached along the bottom, and a "headline", to which floats are attached. The relation of floats to the weighted footrope will determine if the net will float or sink.

A trammel net consists of three layers of net. A slack, small mesh, inner panel of netting is sandwiched between two outer layers of netting, which are taut and have a larger mesh size. The inner panel may be made of twisted or monofilament nylon, whilst the outer panels are generally made of twisted nylon filament. Fish are caught by becoming entangled in the different layers.



*Figure 37: Driftnet of more than 25 km on board a tuna driftnetter operating in the Indian Ocean*



*Figure 38: Roller / guide used on tuna gillnet vessels*



#### **4.4.6. Vessels with alternative gear**

To a large extent the vessel type, construction and layout of fixed gear, such as line or net haulers will provide the first indication of the type of gear most likely to be found on board. Highly specialised vessels such as purse seine vessels are unlikely to be able to use alternative gears without significant and clearly visible alterations to the vessel.

In contrast a vessel designed for deploying and hauling longlines can be altered to use gillnets with little visible modification. The vessel can remove the net hauler (an extension to the capstan) and roller and stow these under tarpaulins so that they are not easily visible or recognised. Vessels that were originally designed for trawling can fit equipment for hauling gillnets or using longlines while still having their trawl net and trawl doors on board. Demersal trawlers for finfish can similarly be altered to target prawn by modifying the nets and footrope without any alteration to its trawl winches or warp drums.



It is important for inspection teams to be able to identify different fishing gears and associate the gear with the equipment used to deploy the gear. Prior to starting the inspection, a checklist can be prepared, based on the information received of what type of gear should be expected. Where reports have been received that the vessel may have been engaged in fishing using unauthorised gear, the inspection team can increase their effort to look for and identify evidence that may support these reports. *Table 10* provides a guide that can be prepared during the inspection brief to direct attention to specific areas on board where the gear components are likely to be found.



*Table 10 - Summary checklist of fishing gear components that can be identified in the primary fishing sectors on larger commercial vessels*

Vessel Type	Gear List	Location on board	
Purse Seine	Purse seine net	Stacked aft with rings on the port side and floats on the starboard side.	
	Skiff	On stern behind the net.	
	Power block	On hydraulic arm on the port side.	
	Two purse wire winches	These are situated next to each other against the starboard side behind the bridge.	

## Port State measures



Procedures for the implementation of the Indian ocean Tuna Commission

Vessel Type	Gear List	Location on board	
Longline (Pelagic / tuna)	Main line storage bin	Line type: Braided monofilament Tarred 4-strand twisted cord Upper deck behind the bridge. Often covered. The hydraulic system to lay the line attached above the bin.	
	Baskets with branch lines / traces and hooks	Packed either on the upperdeck or near stern, these will be covered to protect from sun or can be in storage compartments. [coiled up and made up of mixture of monofilament, multifilament lines and sekiyama wire]. Check for steel trace on the hook.	
	Line hauler	On starboard side of the bridge where the starboard gunwale is cut down	
	Branch line hauler/coiler	Found on the starboard side next to the line hauler.	
	Line setter	Situated right against the stern gunwale.	
	Line thrower	Situated against stern gunwale to port of the line setter.	

Vessel Type	Gear List	Location on board	
Mono system	Main line drum	<p>Large drum with approximately 6mm diameter monofilament nylon On the hauling deck forad of bridge against port side.</p> <p>[Note these systems don't require separate line hauler].</p>	
	Traces	<p>Stored in large tubs with hooks clipped on around side of tub. Usually monofilament.</p> <p>Packed either on the upperdeck or near stern, these will be covered to protect from sun or can be in storage compartments.</p>	
	Traces on reels	Reels of traces are mounted near the stern.	

## Port State measures

### Procedures for the implementation of the Indian ocean Tuna Commission

Vessel Type	Gear List	Location on board	
Other items to check on board longliners	Radio buoys	<p>Often stored, with or without antenna connected, on upper deck directly behind bridge.</p> <p>These buoys must be marked according to IOTC Resolution 19/04: <i>"Each Contracting Party and Cooperating Non-Contracting Party with the IOTC shall ensure that its fishing vessels authorised to fish in the IOTC area of competence are marked in such a way that they can be readily identified with generally accepted standards such as the FAO Standard Specification for the Marking and Identification of Fishing vessels."</i></p>	
	Ridged plastic floats	<p>Stored in a cage usually on the upper deck behind the bridge.</p> <p>These buoys should also all be marked according to IOTC Resolution 19/04.</p>	
	De-hooker & line cutters	<p>Will be packed away with gaffes and harpoons. Often in storage compartment forward of the hauling deck.</p>	

Vessel Type	Gear List	Location on board
Demersal longliners Double line and Trot line	Mainline	Thick floating rope 16 to 22 mm diameter. Stored in a large bin usually close to the stern where setting takes place.
	Ground line of fishing line	<p>These are stored in cases or tubs, approximately 200-meters to a case with 100+ hooks.</p> <p>Stored in compartments close to the stern where setting takes place.</p> <p>May also be found close to the hauling station where lines are repaired and repacked.</p> <p>Trot line sections, 2 to 4 meters long are also stored in tubs or cases but have fewer hooks attached. The hooks are often attached to a single tuna clip in clusters of 3 to 7 hooks.</p>
	Weights or stones	<p>Average weight is between 5 and 10 kg.</p> <p>These can be round stones tied up in a net bag or cast cylindrical or square concrete weights. Some vessels may also use links of steel chain or cast iron "tear drop" shaped weights.</p>
	Line hauler	A double line demersal longliner will have a capstan or large rope hauler for the main line and a line hauler for the bottom line situated next to each other in a hauling station on the starboard side forward of the bridge.
Single or Auto Liner	Magazines	<p>Hooks are attached to a single main line approximately 12mm in diameter.</p> <p>The hooks are suspended from a rail (magazine) with up to 1,000 hooks on a magazine. The magazines are stored in a dedicated compartment at the stern.</p>
	Automatic baiting machine	Found at the setting position at the stern.
Other longline equipment	Anchors	Single and double line longliners use 40 to 80 kg anchors made out of heavy steel rail often with short steel sections protruding at an angle to facilitate grip on the seabed.
	Surface buoys	<p>Radio buoys similar to pelagic longliners stored on the upper deck.</p> <p>Plastic "windy buoys" usually about 60 litres capacity. These may be deflated and stored in compartments below deck to protect them from the sun.</p>



## Port State measures

### Procedures for the implementation of the Indian ocean Tuna Commission

Vessel Type	Gear List	Location on board
Gillnet	Gillnet storage	Gillnets are stored in bins similar to a longline. These are situated close to the stern ready for setting.
	Setting roller	A broad roller may be situated across the stern with high rails on the sides to facilitate setting the net.
	Net hauler	A long capstan drum [up to 1-meter long] used to haul the net back is usually positioned on the starboard side forward of the bridge.
	Net channel or guides	A large diameter pipe or open channel running down the starboard side is used to guide the net back to its storage bin near the stern.
Demersal and pelagic (mid-water) trawl for finfish.	Trawl net	The trawl net will be either packed up on the trawl deck just behind the bridge. On smaller or medium size trawlers the net will most likely be rolled up on a net drum. Packed on the deck or rolled up on a net drum, the codend will be most accessible. This will facilitate measuring the codend mesh size if required.
	Ground gear / bobbins and rock-hopper	The heavier ground tackle is often packed on the sides of the trawl deck.
	Warp drums	The two main warp drums are situated on either side of the trawl deck with the warp leading to large rollers suspended above the stern gunwale.
	Trawl doors	When entering port many trawlers bring the trawl doors inboard onto the trawl deck. The door type can assist in distinguishing between a pelagic or demersal trawler.
Demersal trawl prawn	Beam trawls	Smaller nets held open by ridged beams. As several (up to four) can be towed at any one time these are likely to be dismantled and packed away in storage. The ridged beams (up to 3-meters long) will be stacked on the upper deck near the stern.
	Outriggers	A beam trawler is often distinguished by two outriggers used to tow multiple nets. These will be stowed inboard when the vessel enters port and should be clearly visible on the port and starboard sides.
	Conventional trawl for prawn	Some prawn trawlers are modified from conventional demersal trawlers and tow a single net with doors to keep it open. The gear is lighter than for finfish and the codend will have a noticeably smaller mesh.



## 4.5. Navigation equipment

IOTC CPCs are required to report catch and effort and areas where catches are taken for their fleets operating in the IOTC Area. Parties reporting catches statistics from areas outside the IOTC area must also report these data separately.

When inspecting catch and navigation logbooks and to accurately record coordinates for catch areas in the port inspection report form, inspectors should have a theoretical understanding of position recording in latitude and longitude and basic navigational terms to allow them to analyse and cross reference and verify recorded positions and areas. This requires a basic understanding of position recording in latitude and longitude and the statistical method for reporting catch areas required by the IOTC. A theoretical description of latitude and longitude and some basic navigation terms are provided in Appendix III.

All vessels inspected will have a suite of electronic navigation and communication systems on board (*Table 11*) that should include that shown in *Figure 39* and *Figure 40*.

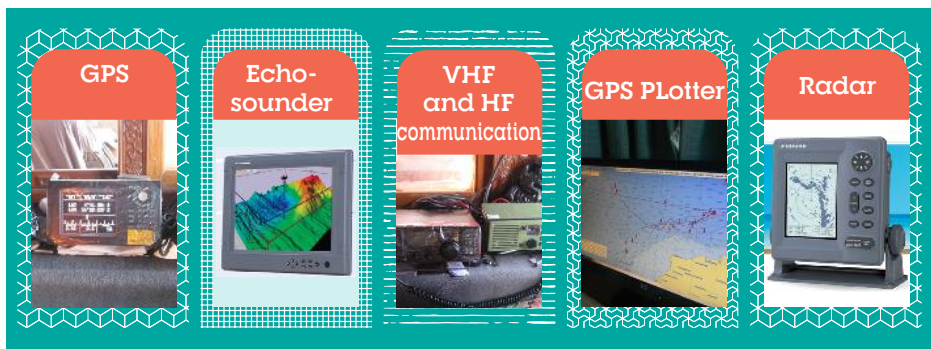

Source: IOTC, 2021

Figure 39: Some navigation & communication systems

## Port State measures



### Procedures for the implementation of the Indian ocean Tuna Commission

More advanced communication equipment is likely to include computerised satellite systems, such as Inmarsat and, on purse seine vessels, a range of sophisticated sonar systems and equipment to interrogate sonar buoys on FADs. The basic electronic navigation equipment that is likely to be found on all vessels is listed in *Table 11* and shown in *Figure 41*. In the event of there being suspicion of a vessel misreporting or falsifying position information, a specialist may be called in to download information from plotters or computerised navigation systems.



*Figure 40: Electronic navigation and communication systems on board purse seiner*

*Table 11 - Basic navigation and communication equipment likely to be found on the bridge of all vessels*

<p><b>Compasses / magnetic / gyro</b></p>	<p>A compass always points to the north and is used to give direction when steaming from one place to the next. Two main types of compasses can be found on the bridge:</p> <p>The magnetic compass, which is affected by the earth's magnetic field and is independent of any source of power;</p> <p>The gyro compass, which is a mechanical compass requiring power to operate.</p>
<p><b>Auto pilot</b></p> 	<p>The auto pilot is used to steer the vessel on a specified course. The auto pilot electronically reads the compass and controls the rudder.</p>
<p><b>GPS / Plotters</b></p> 	<p>GPS (global positioning system) uses satellites to give the precise position of the vessel at all times.</p> <p>Satellites orbiting around the earth are used to determine accurate positions on the earth's surface using a GPS unit. The GPS units show a position as Latitude and Longitude displayed in "degrees, minutes and points of minutes".</p> <p>Note: Most GPS units record positions in degrees, minutes and decimal points of minutes. The points of a minute can be calculated back to seconds by multiplying by 60. Alternatively seconds can be converted to decimal points of a minute by dividing the seconds by 60.</p> <p>For example</p> <p><math>30'' = 30 / 60 = 0.500</math> of a minute</p> <p><math>20'' = 20 / 60 = 0.333</math> of a minute</p> <p><math>50'' = 50 / 60 = 0.833</math> of a minute</p>
	<p>A GPS Plotter is an electronic map which can show the track of the vessel and on which a course can be set. It can be connected to the GPS or operate independently using satellites and will also show the position of the vessel at all times.</p> <p>One of the advantages of the plotter is that the vessels tracks can be saved and recalled. These data can also be copied and transferred to other units and be analysed.</p>

## Port State measures

Procedures for the implementation of the Indian ocean Tuna Commission

### Radar



Radar uses radio waves to reflect off objects within a specific range around a vessel. Radar can show other boats or the coastline in times of darkness or poor visibility.

### Echo sounder



An Echo-sounder transmits a sound wave downwards from below the boat and the time it takes for the reflection from the seabed (echo) to return to the vessel shows the depth of the water. The sound waves also reflect off fish and can assist the skipper to locate fish shoals. The depth on an echo sounder can be recorded in either meters (m) or fathoms (fm) and it is very important to note in which units the depth is being recorded. Remember: 1 fathom = 1.83 m

Modern echo sounders also have facilities to integrate the position with depths recorded and these are saved on the system and can be recalled.

### Radios VHF



Two types of radios are used:

1. VHF (Very High Frequency) has limited range used for local communications up to approximately 25 miles.
2. MF & HF (Medium & High Frequency) for communication over longer distances over 1000 miles.

### Radio HF





© IOTC



© IOTC



© IOTC

**Figure 41:** Communication equipment and computerised satellite systems on board a carrier vessel

## 4.6. Vessel Monitoring Systems

Technology for tracking vehicles and animals using HF radio and radar has been in place for more than twenty years, however tracking of fishing vessels only attracted attention with the advent of satellite technology becoming commercially viable in the mid 1980s. Several countries started implementing VMS on their vessels for Monitoring Control and Surveillance (MCS) in the early 1990s.

VMS systems have an important implication for MCS programs when countries require in their legislation that vessels must install, maintain and keep operational at all times a VMS while engaging in fishing or related activities and at all times when in areas under national jurisdiction. Flag vessels may also be required to keep VMS operational at all times in areas beyond national jurisdiction.

The system allows monitoring agencies to track the vessels' movements, the areas being fished and importantly can indicate when and where a vessel returns to port. It is important to note that VMS only provides tracking information on compliant vessels carrying the units. Non-licensed vessels and vessels not carrying VMS that are involved in IUU fishing will not be monitored and VMS can therefore not replace conventional MCS measures.

IOTC Resolution 15/03, paragraph 1 requires that:

*"Each Contracting Party and Cooperating Non Contracting Party (CPC) shall adopt a satellite-based vessel monitoring system (VMS) for all vessels flying its flag 24 metres in length overall or above or in case of vessels less than 24 metres, those operating in waters outside the Economic Exclusive Zone of the Flag State fishing for species covered by the IOTC Agreement within the IOTC area of competence."*

Paragraph 5 requires that:

*"Information collected shall include:*

- *the vessel identification;*
- *the current geographical position of the vessel (longitude, latitude)*

*with a position error which shall be less than 500 metres, at a confidence level of 99 percent ; and*

- *the date and time (expressed in UTC) of the fixing of the said position of the vessel."*

Inspectors should be familiar with the following when undertaking inspections of VMS shipboard equipment:

- understanding of how VMS functions and its purpose;
- familiarity with the main types of shipboard VMS equipment;
- a general understanding of the different installation options;
- identifying indicators for any evidence of tampering with the system;
- identifying any extra peripherals connected to the equipment and, if found, to query the purpose of these.

#### **4.6.1. VMS functions and types**

The preferred communications medium involves the use of satellite systems because the geographic coverage is greater. Satellites are not the only option, however: several tracking applications for land-based vehicles use cellular telephony or high frequency radio. Some of these other communication systems have similar reliability and security as satellite systems, and may be of lower cost, but they have less coverage and have more applications in near shore fisheries or smaller vessels (Global System for Mobiles - GSM - 6 nm; Coastal Automatic Identification System - AIS - 40 nm).

In a satellite-based system, data reports sent from the vessel are transferred to a satellite and then on to a terrestrial, or "earth", station. The VMS components on the vessel are termed VMS, or sometimes Automatic Location Communicators. These minimally include a GPS antenna and receiver, a processing unit, (which may be embedded or user-supplied), and a transmitter and antenna appropriate for the communications that links the vessel via a land earth station to the fisheries monitoring centre (FMC) ashore. The earth station validates and stores the data, and makes them available to the monitoring agency. The fishery monitoring centre retrieves the data and

## Port State measures

### Procedures for the implementation of the Indian ocean Tuna Commission

stores them in a database. The identity and location of shipboard VMS units are presented on a map display, comparing vessel positions with features of interest, such as maritime boundaries boundaries (e.g. of exclusive economic zones (EEZs) and territorial seas), and regulated fisheries areas.

VMS can broadly be divided into two broad categories:

- one-way communication, transmitting data only from the unit to the shore station;
- two-way, communication, allowing the shore station to communicate (poll) back to the VMS unit on board and re-programme the unit remotely to report at more frequent intervals.

The communications system carries position reports and other messages from the shipboard equipment - VMS, through space and surface lines, to the FMC. Depending on the time interval that positions are transmitted, the information can be analysed to determine the vessel's course and speed. Advantages of being able to poll the vessel and obtain data at shorter intervals are that more detailed and accurate information on the vessels activities at any time can be obtained. The IOTC Resolution 15/03 (paragraph 7) requires:

*"each CPC shall ensure that the information in paragraph 5 is transmitted to the FMC at least once every 4 hours. Each CPC shall ensure the masters of fishing vessels flying its flag ensure that the satellite tracking device(s) are at all times fully operational."*

The predominant service providers used for the space segment in most VMS programmes are Argos, Inmarsat-C and D+, and Iridium. Other service providers include Orbcomm and Qualcomm (EutelTRACS in Europe and Boatracs in North America).

### **Argos**

Argos is a global satellite-based location and data collection system dedicated to studying and protecting our planet's environment. The Argos (CLS) system is carried on polar-orbiting satellites operated by the USA's Nation-



al Oceanic and Atmospheric Administration and the CNES (French Space Agency).

The Argos system (*Figure 42 & Box 22*) results from Franco-American cooperation involving: CNES (French Space Agency), NOAA (National Oceanic and Atmospheric Administration), with support from NASA (National Aeronautics and Space Administration), CLS (Collecte Localisation Satellites), operator of the system. In 2006, Eumetsat (European meteorological organisation) joined the Operations Committee.

The polar-orbiting satellites offer good coverage at high latitudes, and process one-way, ship to shore, communications (two-way communications are planned). Argos positions are provided in either of two ways: GPS positions for shipboard units that have an integrated GPS, and positions calculated by measuring Doppler shift for units both with GPS and those without it. Ship-board equipment for Argos service is manufactured by several companies (Source <http://www.argos-system.org>).

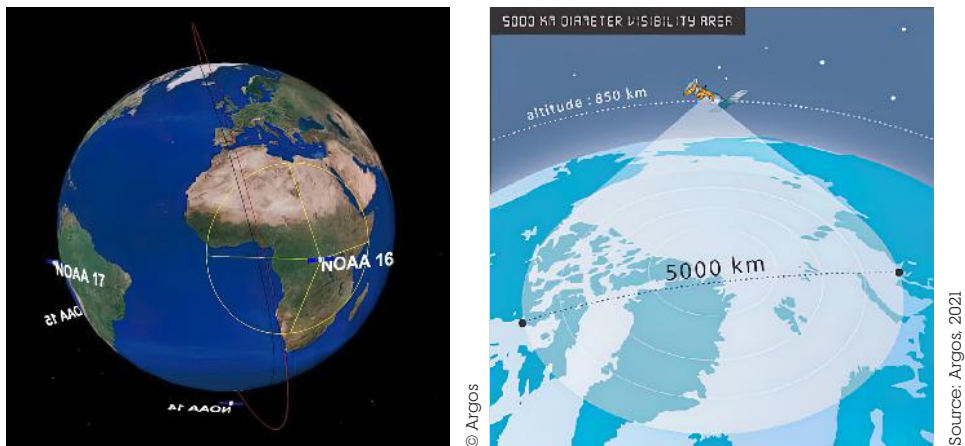

Figure 42: Argos satellites constellation and coverage

## Port State measures

Procedures for the implementation of the Indian ocean Tuna Commission

### Box 22 | Argos system

- Six operational satellites : K, L, M, N, N', Metop
- Polar orbit satellites
- 1 orbit is run in around 100 min
- Altitude: 850 kms
- Ground area: 5000 kms diameter
- Average duration of a satellite pass = 10 min

### Inmarsat

Inmarsat (*Figure 43 & Box 23*) was originally founded in 1979 as the International Maritime Satellite Organisation (Inmarsat), a not-for-profit international organisation, set up at the behest of the International Maritime Organisation (IMO), a UN body, for the purpose of establishing a satellite communications network for the maritime community.

Inmarsat C is a cornerstone of the Global Maritime Distress and Safety System (GMDSS) supporting five out of nine communication functions defined in the IMO SOLAS Convention, Chapter IV. It is a packet data communication system providing store and forward messaging including e-mailing, distress alerting and distress priority messaging to associated Rescue Coordination Centres, reception of maritime safety information via the International SafetyNET service, data reporting and polling service.

Inmarsat-C and Inmarsat-D+ services use geostationary satellites along the equator, providing almost global two-way coverage. Because of the satellites' equatorial locations, coverage at low latitude is good but may be incomplete at very high latitudes (around 70°). Inmarsat offers several types of communication service, but Inmarsat-C and D+ are most suitable for VMS applications as they are cost-effective for text messages and data packets. Shipboard equipment for Inmarsat-C and D+ service is manufactured by several companies.

### Box 23 | Inmarsat system

- 4 geostationary satellites at an altitude of 36000 kms
- Alphasat, with a very high bit rate, expected launch in 2012
- Fleet broadband voice and data simultaneously at a high rate (432 kb/s)

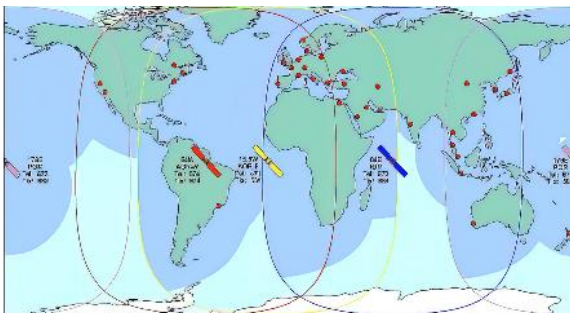

Source: Inmarsat, 2021

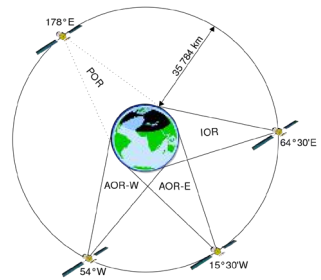

Source: Inmarsat, 2021

Figure 43: Inmarsat satellites constellation and coverage

### Iridium

The Iridium satellite constellation (*Figure 44 & Box 24*) is a large group of satellites providing voice and data coverage to satellite phones, pagers and integrated transceivers over Earth's entire surface.

The constellation consists of 66 active satellites in orbit, and additional spare satellites to serve in case of failure. Satellites are in low Earth orbit at a height of approximately 781 km and inclination of 86.4°. Orbital velocity of the satellites is approximately 27,000 km/h.

## Port State measures

Procedures for the implementation of the Indian ocean Tuna Commission

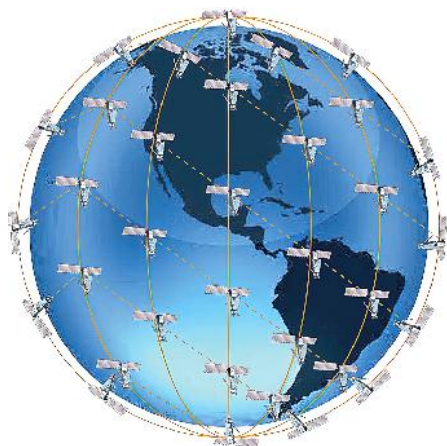

Source: Iridium, 2021



Source: Iridium, 2021

Figure 44: Iridium satellites constellation and coverage

### Box 24 | Iridium system

- 66 satellites between altitudes of 780 and 800 kms
- 6 orbit plans
- Frequency = Ka and L bands
- The signal is forwarded from 1 satellite to another satellite before being downloaded and processed at Phoenix in Arizona

## Orbcomm and Qualcomm

The Orbcomm (*Figure 45*) system employs multiple satellites in low earth orbit. The Orbcomm earth stations process global, two-way data communications. Two types of VMS programmes are available from Qualcomm - Boatracs and EutelTRACS. Position reports are provided in either of two ways: GPS positions for shipboard units that have an integrated GPS, and positions calculated by measuring Doppler shift (for units with and without GPS). EutelTRACS covers Europe and adjacent portions of the Atlantic Ocean, the Mediterranean and the Middle East. Boatracs covers eastern North America and adjacent portions of the Atlantic Ocean. The Qualcomm systems provide two-way communications.

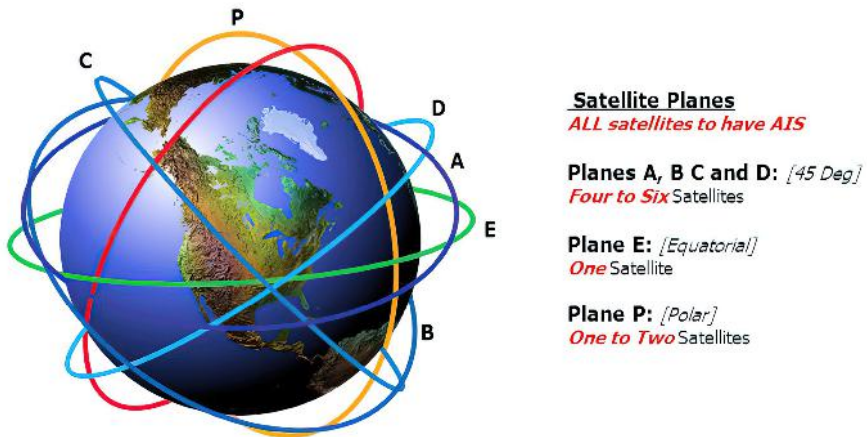

*Figure 45: Orbcomm satellites constellation and coverage*

#### **4.6.2. VMS identification guide**

The following is a guide to assist identifying the VMS systems fitted to tuna fishing vessels during inspections.

Note the antenna size and shape as it is fitted above the bridge and must not be confused with other electronic navigation antennae.

##### ***Thrane & Thrane (Sailor) Capsat TT-3022D***

This includes the re-badged Sailor 3022D or Capsat units and appears to be those most commonly fitted. The Sailor 3022 D unit is an exact unit as the Thrane and Thrane 3022 D, but olive green in colour (*Figure 46*).



© IOTC



© IOTC

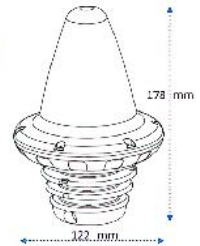

© IOTC

The terminal dimensions are L 180 x l 165 x H 50 mm for a weight of 2.9 kg.  
The antenna dimensions are 122 Ø x L 178 mm for a weight of 0.9 kg.

*Figure 46: Thrane & Thrane (Sailor) Capsat TT-3022D unit and antenna*

### ***Thrane & Thrane (Sailor) Capsat TT-3026S Mini C***

The Inmarsat-C is a communication system, which enables the user to send and receive data to and from mobile terminals. The Inmarsat-C system provides the possibility of reaching remote areas where other methods of communication are impossible. The Inmarsat-C satellite network provides the link between the mobile and the destination office. It uses four geostationary satellites to cover the world. Satellite data link coverage is complete between 70° North and 70° South. Because the Polar regions cannot be seen from geostationary satellites these regions are not covered.

## Port State measures

Procedures for the implementation of the Indian ocean Tuna Commission

The family mini Capsat TT-3026M/S/D (Figure 47) are three different models. The TT-3026S include EGC SafetyNet and FleetNet reception capabilities. It is fully compliant with the latest Inmarsat-C specifications for SOLAS/GMDSS with distress, he has 2-way data, fax, and e-mail transfer to destinations worldwide, data and position reporting to multiple destinations and time intervals. Built-in Vessel Monitoring System allows event-based position reporting.



© IOTC

© IOTC



© IOTC

The terminal dimensions are L 117 x l 64 x H 22 mm for a weight of 0.3 kg.  
The antenna dimensions are 163 Ø x L 146 mm for a weight of 1.1 kg.

Figure 47: Thrane & Thrane (Sailor) Capsat TT-3026S Mini C Unit and antenna

## Trimble Galaxy

Galaxy (Figure 48) enables users to access the Inmarsat-C two-way messaging service from virtually anywhere in the world. Maritime users can exchange messages with their offices and other vessels using 5-bit, 7-bit, or 8-bit transmissions. The messages can be sent via telex, internet email, fax, or PSDN delivery. These units are fitted to many tuna vessels from the fleet of Taiwan, province of China.





© IOTC

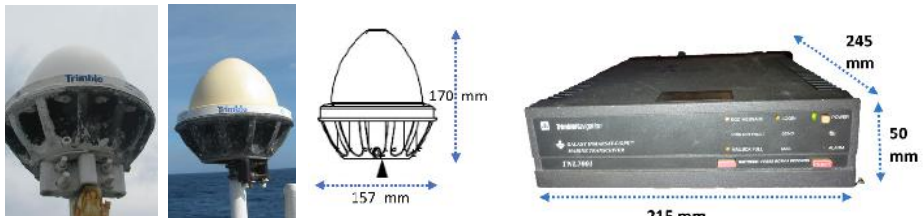

© IOTC

The terminal dimensions are L 245 x l 215 x H 50 mm for a weight of 2.9 kg.  
The antenna dimensions are 157 Ø x L 170 mm for a weight of 2 kg.

Figure 48: Trimble galaxy unit and antenna

## Argos

The electronic components of the Argos unit are entirely enclosed within the dome shaped "aerial" of the unit. This is mounted externally with a good view of the sky - usually above the bridge. The dome is white, measures 300mm in diameter and 160mm in height and is mounted on top of a pole. The dome will be connected to a junction box that is mounted indoors - usually in the communications area.

Numerous Argos VMS transmitters have been marketed, of different kinds. They are generally known under a generic name MAR GE (MAR GE RB, MAR GE, MAR GE V2, MARGE V3, LEO, Vela). Most common model that can be found on the field nowadays is the MAR GE V2.

## Port State measures

Procedures for the implementation of the Indian ocean Tuna Commission

### Argos MARGE

The MAR-GE Argos-GPS transmitter (*Figure 49*) is specially designed for fishing vessel monitoring. It automatically transmits the position, speed, and heading of the fishing vessel to the Argos satellite system. The MAR-GE can also transmit catch reports which include fish species and quantities with a data terminal. It has a full global coverage (from north to south pole), and backup positioning by the Argos satellite system as well as a backup battery in case of main board power failure.



The terminal dimensions are 125 x 80 x 55 mm for a weight of 0.50 kg.  
The antenna dimensions are 300 Ø x H 160 mm for a weight of 2.4 kg.

Figure 49: MARGE unit and antenna

## Argos MARGE V2

The MAR GE V2 Argos-GPS transmitter (*Figure 50*) is specially designed for fishing vessel monitoring. It automatically transmits the position, speed, and heading of the fishing vessel to the Argos satellite system. The MAR GE V2 can also transmit catch reports which include fish species and quantities with a Pson data terminal or with a PC.



The terminal dimensions are L 150 x 160 x H 100 mm for a weight of 0.48 kg.  
The antenna dimensions are 165 Ø x H 135 mm for a weight of 1.45 kg.

*Figure 50: Marge GE V2 unit and antenna*

## Port State measures

Procedures for the implementation of the Indian ocean Tuna Commission

### Argos (Seimac) FVT

The FVT (*Figure 51*) acquires GPS positions of the fishing vessel from a built in GPS receiver and relays these positions via ARGOS satellite system. The FVT has a full coverage from North to South pole with positions every hour or half hour.

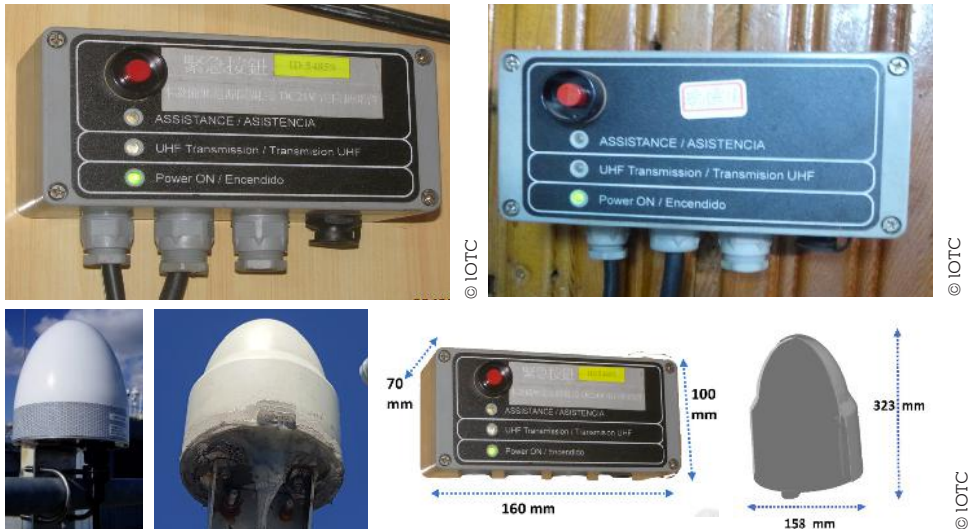

The terminal dimensions are L 160 x l 100 x H 70 mm for a weight of 0.50 kg.  
The antenna dimensions are 158 Ø x H 323 for a weight of 2.8 kg.

*Figure 51: Seimac unit and antenna*

### Argos CLS LEO

The LEO (*Figure 52*) has global coverage and real-time position reports (with speed and heading), zone management (geo-fencing), airtime cost control by zone (at port) and has REMOTE CONTROL (Consultation of terminal parameters (ON, OFF, battery on, etc.), modification of terminal settings (report-

ing frequency...), positions on demand (polling), consultation of archived positions (tracking replay mode), sensor monitoring. The ALARM functions are: alarms triggered by geographic event (entry/exit of zone, vessel at port or stationary) or by modification of a technical parameter (loss of Iridium or GPS signal, power supply failure, battery back-up ON/OFF...). It has a global satellite tracking, logbook and email (Iridium), up to 90 days data memory.

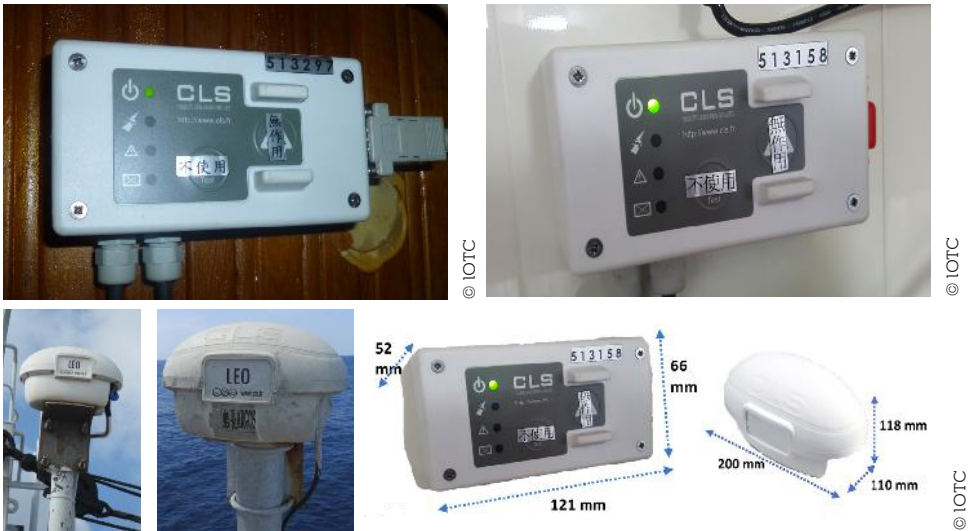

The terminal dimensions are L 121 x l 66 x H 52 mm for a weight of 145 g.  
The antenna dimensions are L 200 x l 110 x H 118 mm for a weight of 762 g.

Figure 52: LEO unit and antenna

## CLS VELA

VELA (Figure 53) is an ARGOS/GPS transmitter specifically designed for fishery vessel monitoring. It automatically transmits the position, speed and heading of the vessel by the Argos satellite constellation. VELA has a full global coverage (from north to south pole), GPS positions reported at regular intervals (every 60 minutes), Robust design for harsh environments, 48 h bat-

## Port State measures

Procedures for the implementation of the Indian ocean Tuna Commission

tery life in case of main board power failure. VELA terminal is a ship and fleet tracking solution. It has been designed for maritime tracking on board ships with an IP66 dome. Position, speed and heading of vessels are transmitted by the ARGOS satellite constellation, the brainchild of various international space agencies. The reason for VELA terminal being more affordable is that the VELA terminal utilises ARGOS transmissions that are not real-time but serves its purpose of tracking vessels sufficiently. Although tracking is delayed, it is possible to get a position every 15mins if required.

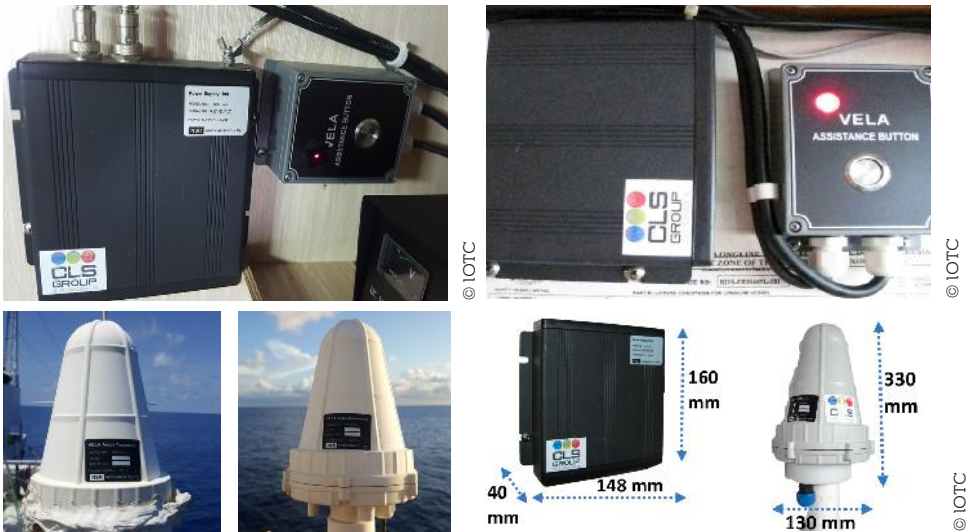

The terminal dimensions are L 148 x l 160 mm x H 40 mm for a weight of 0.9 kg.  
The antenna dimensions are 130 Ø x 330 mm height for a weight of 1.5 kg.

Figure 53: CLS VELA unit and antenna

### CLS Thorium TST-100 (Iridium)

The Electronic components of the Thorium TST unit (Figure 54) are entirely enclosed within the dome shaped "aerial" of the unit. This is mounted externally with a good view of the sky - usually above the bridge.

A junction box is mounted in the cabin so as to allow two-way communications and remote diagnostics thanks to small LED lights. GPS position report sent at regular intervals (every 6h, 3h, 1h, 30 minutes, 15 minutes). On-demand GPS position (polling), ship speed and heading also transmitted. Transmission time is less than 5 minutes (95 percent)

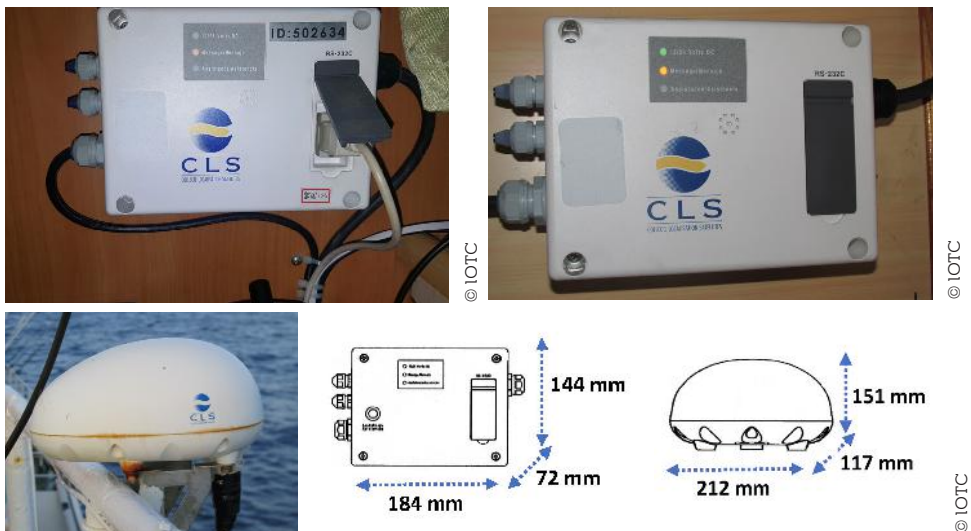

The terminal dimensions are L 184 x l 144 x H 72 mm for a weight of 500 g.  
The antenna dimensions are L 212 x H 151 x l 117 mm for a weight of 1.2 kg.

Figure 54: Thorium TST unit and antenna

### Furuno Felcom 16/19

The FELCOM 19 (Figure 54) mainly consists of an antenna unit and a communication unit. Connected to a PC, the FELCOM19 provides the full range of general communication services for mobile and fixed terrestrial subscribers

## Port State measures

### Procedures for the implementation of the Indian ocean Tuna Commission

in the Inmarsat C communication network. Its compact size permits installation where space is limited.

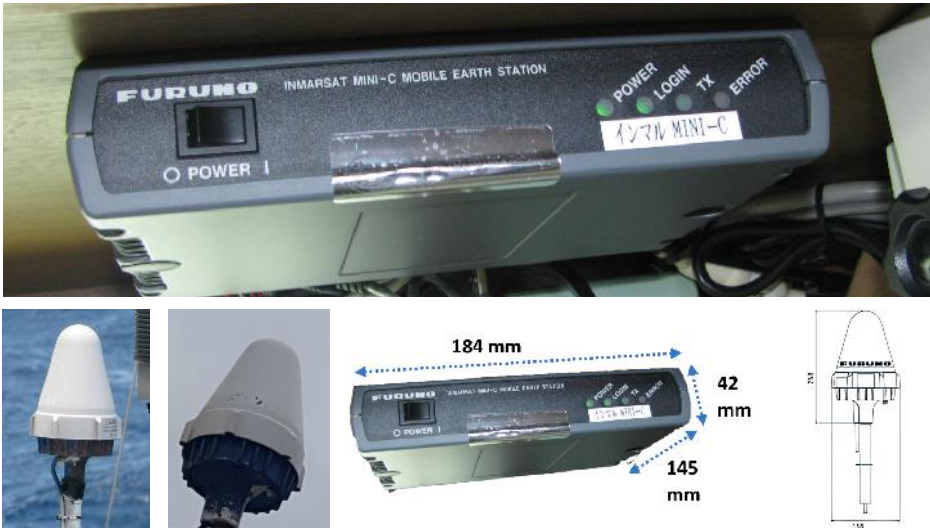

The terminal dimensions are L 187 mm x l 145 mm x H 42 mm for a weight of 1.2 kg.  
The antenna dimensions are 156 Ø x L 258 mm for a weight of 1.4 kg.

Figure 55: Furuno Felcom unit and antenna

## Japan Radio Company (JRC) JUE-95VM

With the JUE-95VM Inmarsat C, (Figure 56) VMS, JRC has developed a compact, mobile satellite communication system, to allow quick and easy worldwide tracking of a vessels precise location, utilising two-way data messaging. Fisheries monitoring are usually costly and difficult. JRC's formidable formula, a compact, affordable JUE-95VM system, integrating the latest technologies, makes monitoring of fishing activities cost-effective and highly accurate.





© IOTC



© IOTC

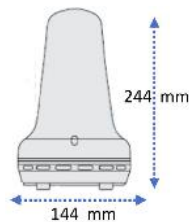

The terminal dimensions are L 210 x l 150 x H mm for a weight of 1.3 kg.  
The antenna dimensions are 144 Ø x L 224 mm for a weight of 1.5 kg.



© IOTC

Figure 56: JRC JUE-95VM unit and antenna

### **Thrane & Thrane (Sailor) Capsat (6194 terminal control unit TT3027D Antenna)**

The SAILOR 6194A TCU (*Figure 57*) is a key part of the mini-C revolution since it is an active box with a small microprocessor that can handle NMEA, CAN and LAN. Another feature added as a direct result of end-user feedback is the three status LED's that can provide information on Inmarsat signal and log-in, GPS fix, DN1D and program download. SAILOR 6194A terminal control unit is used for the following purposes: for connecting covert alert buttons

– Inspector appointment and training –

## Port State measures

Procedures for the implementation of the Indian ocean Tuna Commission

for use in Ship Security Alert (SSA) systems, or SAILOR 6108 Non-SOLAS Alarm Panels or SAILOR 3042E Alarm Panels in Non-SOLAS Distress systems, for connecting a SAILOR 3027 terminal, which has a CAN interface, with other equipment that has Ethernet or RS-232 interface, for executing custom scripts that can react on events registered by the Terminal Control Unit, e.g. in SCA-DA applications and for vessel monitoring. The Terminal Control Unit is supported by the Thrane LINK Management Application, a Windows program that provides easy monitoring and software update of connected Cobham SATCOM devices with Thrane LINK support.



The terminal dimensions are L 222 x l 110 x H 52 mm for a weight of 1.3 kg.  
The antenna dimensions are 157 Ø x 170 mm for a weight of 1.1 kg.

Figure 57: Thrane & Thrane (Sailor) Capsat 6194 terminal unit and antenna

### CLS Triton (Iridium)

The Triton Advanced Terminal (*Figure 58*) automatically transmits the position, speed and heading of the vessel via the Iridium satellite system. It is robust, highly reliable and easy-to-install. The Advanced version with the junction box can also transmit/receive catch reports, emails, weather data, on demand. It can also connect to an Android tablet with Bluetooth or laptop via a USB port. Tamperproof: 1. Tampering detector if transceiver is dismantled, 2. Tamperproof screws, 3. Tampering detector that generates a warning message when the dome is opened.

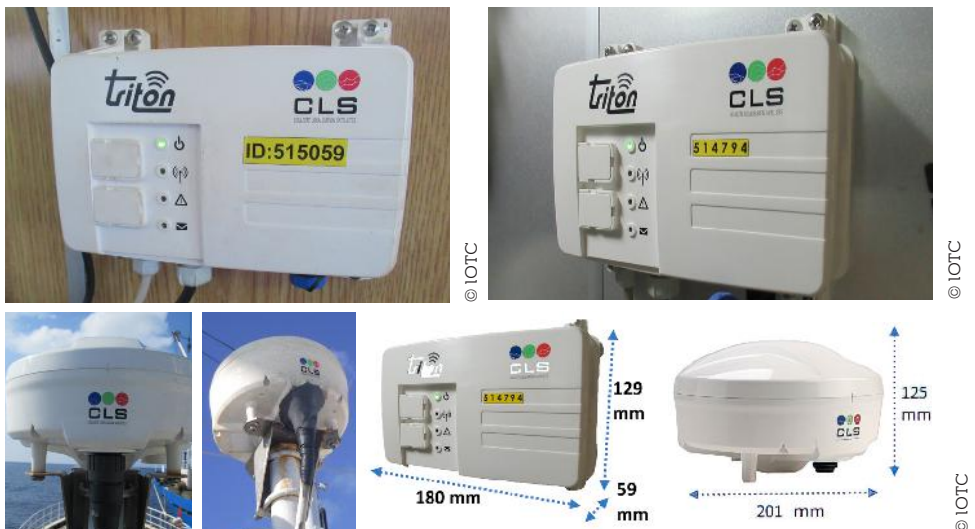

The terminal dimensions are L 180 x l 129 x 59 mm for a weight of 0.36 kg.  
The antenna dimensions are 201 Ø x 125 mm for a weight of 1.65 kg.

*Figure 58: CLS triton (Iridium) unit and antenna*

## Port State measures

Procedures for the implementation of the Indian ocean Tuna Commission

### Cobham/SAILOR 250 FLEETBROADBAND

In addition to complete office communication functionality, VPN and use of IP applications, SAILOR 250 (Figure 59) Fleet Broadband can be used for dedicated tracking and telemetry applications. This advanced functionality can enhance efficiency by ensuring your support on shore has all the information they need, from real-time engine data for maintenance to position data for fleet tracking and management.

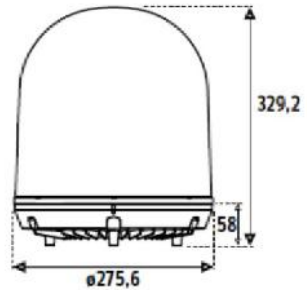
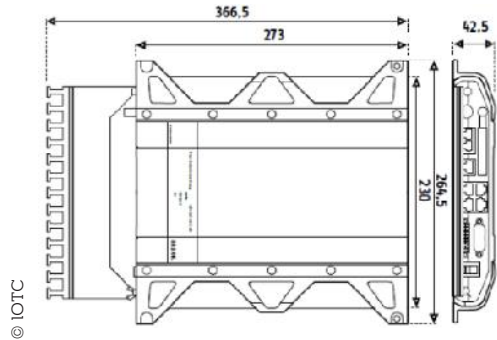

The terminal dimensions are L 273 x l 264 x H 42.5 mm for a weight of 2.5 kg.  
The antenna dimensions are 275 Ø x H 329 mm for a weight of 4.2 kg.

Figure 59: Cobham/SAILOR 250 FLEET BROADBAND unit and antenna

### Pole Star MAT - IDP690 (Figure 59)



The terminal dimensions are L 194 x W114 x D59 mm for a weight of 0.48 kg.  
The antenna dimensions are L 125.8 x H 100.8 mm for a weight of 0.46 kg.

Figure 60: Pole Star MAT - IDP690 unit and antenna

### BEAM Oceana 800

Oceana 800 (Figure 61) has an in-built GPS module that can provide tracking, monitoring and instant messaging in maritime based applications within various types of vessels. The GPS module provides accurate positioning and enables tracking worldwide. The tracking function has to be configured and enabled on the Oceana 800 via the Falcon. Once turned ON, tracking and instant messages can be sent to a phone number, e-mail address, or any tracking application via SMS/email.

## Port State measures

Procedures for the implementation of the Indian ocean Tuna Commission



The terminal dimensions are L 210 x l 150 x H 50 mm for a weight of 1.3 kg  
The antenna dimensions are 224 Ø x H 144 mm for a weight of 1.5 kg.

Figure 61: BEAM Oceana 800 unit and antenna

## Glocom GX-9

Glocom's GX-9 (Figure 62) user terminal has been designed to bring a variety of communication services to the small and medium sized vessel owner/operator, including voice and internet with IP packet data up to 384 kbps downloads in a shared channel.



© IOTC



© IOTC

The terminal dimensions are l 275 x L 345 x H 50 mm for a weight of 2.8 kg.  
The antenna dimensions are 330 Ø x H 270 mm for a weight of 3.9 kg.

*Figure 62: Glocom GX-9 unit and antenna*

### ***Multiple VMS units on board vessels***

Some industrial tuna vessels have two different VMS units (Figure 62 & 63) installed on board (Figure 63 & Figure 64). One of the units transmit the positions to the flag State FMC while the 2nd VMS unit transmit positions to the coastal State FMC where the vessel is licensed to operate in the waters. Both of these units have small LED Lights to indicate that the units are switched on. However, this does not indicate when precisely the unit is transmitting the VMS data so as to avoid intentional jam of the signal. These units will have a dome shape aerial mounted above the bridge. The VMS boxes visible in this photo are the junction boxes for power.

## Port State measures

Procedures for the implementation of the Indian ocean Tuna Commission



Figure 63: Two VMS units installed on board a tuna longliner (Thrane & Thrane 3022D INMARSAT and Junction Box of the Trimble Galaxy unit)



Figure 64: Two VMS units installed on board a tuna longliner (Thrane & Thrane 3022D INMARSAT and Junction Box for the Argos MARGE unit)

### 4.6.3. Means used by vessel to tamper with or falsify VMS data to prevent detection of IUU fishing activities

Physical interfering or 'tampering' with the shipboard transponder equipment (Figures 64 & 65) to falsify information or data transmitted in order to prevent monitoring and detection of potential infractions can be grouped into the following categories into the categories in [Figure 65](#).



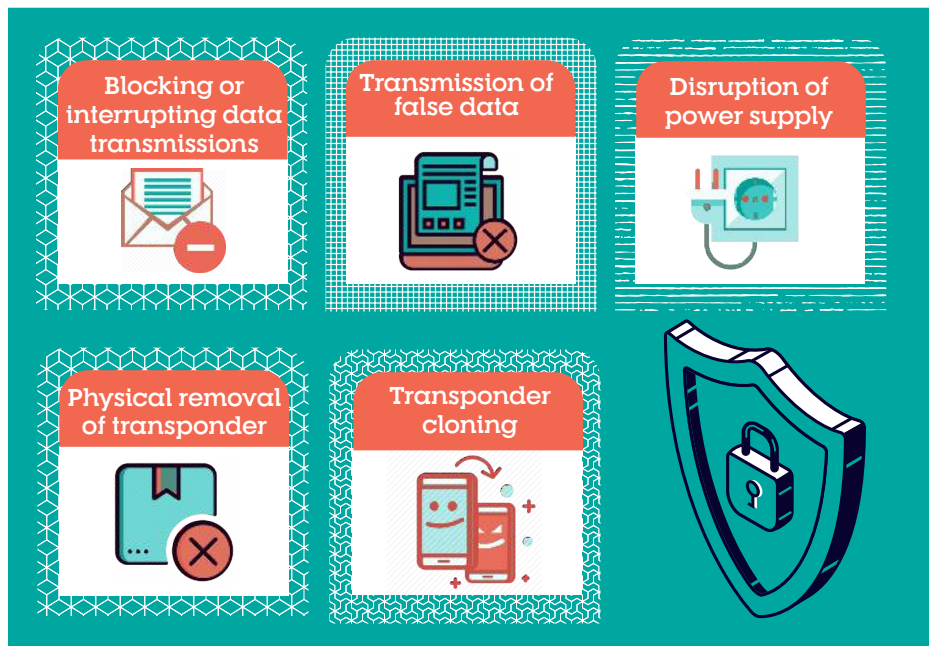

Figure 65: Tampering with the shipboard transponder equipment to falsify data transmitted

### **Blocking or interrupting data transmissions**

This can involve covering the antenna (such as with a metal bucket), coating the antenna with metal-based paint and/or disconnection or removal of the antenna cable. If suspected by the FMC and/or the inspector, detailed inspections will be required of the antenna and antenna cable for signs of interference such as metal based paint residue around the vicinity of the antenna.

It is difficult to prevent this type of tampering and rigid penalties will only assist. However, the use of security sealed connectors on the antenna cable will make it more difficult to tamper with the connections.

– Inspector appointment and training –

## Port State measures

### Procedures for the implementation of the Indian ocean Tuna Commission



Figure 66: Argos junction Box with on/off switch



Figure 67: Argos junction Box switched off

### **Transmission of false data**

This is where position reports are input manually and then transmitted. Such overriding of the transponder's internal GPS would have to be done by a programmable GPS unit or computer software that is able to falsely simulate GPS information. On board, evidence of this will be difficult to detect but more recent transponders or those 'type approved' "e.g. as a condition of licence", that are completely sealed and/or are equipped with security seals will make this more difficult.

### **Disruption of power supply**

This involves either turning off the transponder in the usual way (Figure 67) or removal of power cables, so again look for evidence of cable interference (Figure 66). Type approving will deter this to some extent by for example, specifying the use of units with an auxiliary battery supply that will continue to transmit even after the primary power source has been interrupted and notify the FMC of the power interruption.

### ***Physical removal of transponder***

This literally involves removing the transponder from the vessel which may then be placed on another vessel, thus leaving the vessel to go unmonitored.

Looking for signs of removal behind and in the vicinity of the transponder alongside evidence of re-wiring or disconnection of the cable should be undertaken. Type approval of installation procedures which would make removal more difficult, and the use of security seals on both the antenna and transponder with associated fines for such tampering will assist with the detection of this form of tampering. As VMS transponders are assigned to a particular vessel, the vessel registration papers should be carefully examined to verify that they are genuine if such an activity is suspected.

### ***Transponder cloning***

This involves placing a second transponder on board that is capable of adopting the same behaviour as the approved one but can facilitate the simulation of false positional information. This type of tampering is technically complex and evidence of this is difficult to detect during an inspection. Much of the prevention for this rests with the manufacturer (the use of unique internal identifier known only to the manufacturer and system operator). If any of the above actions are suspected, the equipment suppliers should be contacted for verification. This can be done with Argos transponders by comparing the Doppler track with the VMS track. Some INMARSAT transponders have a sealed data logger which can also be consulted by the supplier and will normally show any discrepancy between the recorded and reported positions.

#### ***4.6.4. On board inspection of the VMS***

The vessel's notification to enter port requires listing the type of VMS unit installed and the FMC to which it reports. Where possible the inspection teams should obtain the VMS records from the FMC prior to the inspection taking place. Effectively only the land-based national Fisheries Monitoring Centre receiving the VMS information can confirm if the system is operating correctly. However, depending on the preliminary assessment of the VMS

## Port State measures

### Procedures for the implementation of the Indian ocean Tuna Commission

information, the inspection team will have to make a decision on whether to undertake a routine inspection or, where falsified VMS information is suspected, a more detailed investigation may be initiated that could also include inviting specialists in the field to accompany the inspection team.

A routine checklist to verify that the VMS equipment meets with the conditions of IOTC Resolution 15/03 is described in [Box 25](#).

#### Box 25 | Checklist for the inspection of VMS

1. The VMS unit must be installed on vessels above 24 metres in LOA or above or in case of vessels less than 24 meters, those operating in waters outside the Economic Exclusive Zone of the flag State fishing for species covered by the IOTC Agreement within the IOTC area of competence.
2. The VMS unit must be located with a sealed unit, and protected by seals (or mechanisms) of a type that indicates whether the unit has been accessed or tampered with (tamper proof). Verify for evidence of the unit being tampered with, such as broken seals, scratch marks on screws sealing the unit, evidence of the cable junctions being removed.
3. The VMS unit must be switched ON at the time of inspection and have reliable power feed and / or internal auxiliary power supplies.
4. The state of the cables leading into and out of the unit should be checked.
5. The routing of the cable to other units should be checked.
6. The condition of the antenna: evidence of paint on the antenna or connectors is evidence of recent changes.

## 4.7. Powers of fisheries inspectors

The fishery inspector's authority is exercisable throughout the territory and waters of the country may extend to flag vessels in areas beyond national jurisdiction. Inspectors' powers are described in the fisheries legislation and they must have knowledge of their exact powers under their country's legislation.

The powers usually include: boarding vessels and entering premises ashore and carrying out inspections; inspecting vessels, licences, authorisations, records and documents, gear, catch and equipment; requesting information from the master and crew; and general powers of search. The authority assigned to inspectors should grant them the power to collect evidence and seize necessary exhibits, particularly where there are reasonable grounds to believe that a vessel has been involved in IUU fishing or related activities.

The power of seizure and arrest may be included, but if not the inspector should be accompanied by an officer who has such power (for example a fisheries authorised officer or member of the police or defence agency).

Inspectors must be issued with and carry at all times identification that provides proof of their appointment and powers as an inspector.

The results from analysing information in the advance request to enter port are likely to provide the first indication that the vessel may be implicated in IUU fishing (*Box 26*) or related activities. This will alert the inspection team and possibly guide them to the most probable source of evidence required to confirm or dispute these suspicions. However, it is also possible that verification of documents and gear and catch inspection may reveal evidence of IUU fishing or related activities not previously suspected.

#### **4.7.1. Collection of evidence and follow-up actions**

Where there are grounds to suspect a vessel has been engaged in IUU fishing, an important task of the inspection team will be to collect and record evidence to support these suspicions. The evidence will have to be submitted to the IOTC Secretariat and the flag State of the vessel and must be judicially sound

IOTC Resolution 18/03, *Establishing a list of vessels presumed to have carried out illegal, unreported and unregulated fishing in the IOTC area of competence*, requires CPCs in possession of information that one or more vessels has engaged in IUU fishing activities within the IOTC Area within a 24 month period prior to the annual meeting of the Compliance Committee to submit a list of such vessels to the IOTC Executive Secretary using the IOTC Reporting Form for Illegal Activity in Annex 1. The list must be accompanied by information gathered from inspections undertaken in port or at sea, and Annex 1 requires associated documents to be attached, such as boarding reports.

Annex 1 calls for information on the details of the vessel and of the IOTC Resolution elements contravened, and the inspection reports should have sufficient evidence to support the proposal for vessel listing.

The inspector must have a sound knowledge on how to recognise, collect, preserve and record evidence, and maintain the "*chain of custody*" in order to satisfy the legislation and legal or administrative processes of his or her country and, as necessary, the requirements of IOTC for vessel listing.

The "*chain of custody*" refers to the chronological documentation or recordings that reflect the sequence of custody, control, transfer, analysis, and disposition of physical or electronic evidence. Evidence presented in legal or administrative proceedings must be verified by reporting on the chain of custody.

To preserve evidence, it is important that the rules of evidence are strictly observed according to the legislation of the port State in terms of the way the raw material (film, memory cards, documents, etc) are handled and stored.

The generally accepted steps while preserving evidence are presented in *Figure 68*.



Source: IOTC, 2021

*Figure 68: Preserving evidences: main steps*

Inspectors may also be required to present themselves as expert witnesses where judicial or administrative processes are set up for prosecution, compensation or other actions as a result of the alleged contravention.

**Box 26 | IOTC definition of IUU fishing activities (Resolution 18/03)**

*For the purposes of this resolution, fishing vessels are presumed to have carried out illegal, unreported and unregulated fishing activities when a Contracting Party or Cooperating non-Contracting Party ("CPCs") has provided information that such a vessel has, within the IOTC Area and in relation to species covered by the IOTC Agreement or by IOTC Conservation and Management Measures:*

- a. engaged in fishing or fishing related activities and is neither registered on the IOTC Record of Authorised Vessels in accordance with Resolution 15/04 [superseded by Resolution 19/04], nor recorded in the Active list of vessels; or
- b. engaged in fishing or fishing related activities when its flag State is without quota, catch limit, or effort allocation under IOTC Conservation and Management Measures where applicable unless that vessel is flagged to a CPC ; or
- c. failed to record or report its catches in accordance with IOTC Conservation and Management Measures or has made false reports; or
- d. taken or landed undersized fish in contravention of IOTC Conservation and Management Measures; or
- e. engaged in fishing or fishing related activities during closed fishing periods or in closed areas in contravention of IOTC Conservation and Management Measures; or
- f. used prohibited fishing gear in contravention of IOTC Conservation and Management Measures; or
- g. transhipped fish to, or otherwise participated in joint operations with, support or re-supply vessels that are not included on the IOTC Record of Authorised Vessels or not on the Record of Vessels Authorised to Receive Transshipments At-Sea in the IOTC Area; or
- h. engaged in fishing or fishing related activities in waters that are under the national jurisdiction of a coastal State without the permission or authorisation of that State or in contravention of the laws and regulations of that State (without prejudice to the sovereign rights of the State concerned to undertake enforcement measures against such a vessel); or
- i. engaged in fishing or fishing related activities whilst being without nationality; or
- j. engaged in fishing or fishing related activities having intentionally falsified or concealed its markings, identity or registration; or
- k. engaged in fishing or fishing related activities in contravention of any other binding IOTC Conservation and Management Measures.



Every case will be different and the evidence will vary from case to case. Entries in logs, marks on charts, evidence of VMS tampering, computer navigation equipment (on laptops), electronic plotters, together with any prohibited species and other catch thought to be caught in contravention of license conditions or management measures will all be considered as evidence. Other evidence available from the FMC may include VMS data (if any) or any other sightings from national sea or air assets as well as another cooperating party. More and more evidence is becoming accepted and admissible in fisheries cases, in some countries photos of illegal activity taken from aircraft that are endorsed by the plane's pilot as having been taken at the time and place specified are admissible evidence.

In support of evidence of IUU fishing, as a minimum, the following should be collected including copies, highlighting incorrect entries, such as those in *Figure 69*.

## Port State measures

### Procedures for the implementation of the Indian ocean Tuna Commission



Figure 69: Preserving evidences: collection of documents

Examples of photographic evidence are provide in *Figure 69*.



Source: IOTC, 2021

*Figure 70: Preserving evidences: photographs to be taken*

#### **4.7.2. Interviewing, recording and witness statements**

Cameras and video cameras are used to photograph marking of the vessels, documents, fishing gear, equipment, catch and working spaces as required. Any significant events during the inspection should be photographed or videoed as a basis for later evidence.

Video and voice recordings are to be labelled and securely saved by the inspector for later use. They may be used to record interviews with the master and crew members. However, it is essential that:

## Port State measures

### Procedures for the implementation of the Indian ocean Tuna Commission

- the master or crew member is informed that the interview is being tape recorded;
- the master or crew-member is read his/her rights before an interview starts, especially if the interview is likely to be used as evidence for further legal action;
- there must always be two inspectors in the interview room;
- the preamble to the interview must contain a clear statement by the interviewing inspector such as that provided in **Box 27**.

#### Box 27 | An example of a preamble

"This is .... [NAME OF THE INSPECTOR].... on board the fishing vessel .... [NAME OF VESSEL].

The date is .... [DATE]...., the time is.... [TIME]....,

I am interviewing the master of the vessel .... [NAME]... with regard to ...[NATURE OF THE POSSIBLE VIOLATION(s) and/or general compliance with national legislation and iotc measures]...

Mr [NAME and position OF PERSON INTERVIEWED] has been read his legal rights and understands them. He is taking part in this interview voluntarily.

Also in the room are .. [NAME OF OTHER INSPECTOR AND ANYONE ELSE IN THE ROOM].

At the end of the interview, the inspector must close the recording with a statement of the time the interview finished. Notes of the main points of the interview are to be recorded in the notebook. Video recordings should digitally display, where possible, the date and time of the recording. The title or label of the recording must state who is participating, date, time, and location, and it must be securely saved.

Interviews of the vessel master and other crew members can be a vital evidence source (assuming that they are voluntary). Aside from dates, times, names, and signatures, other more important guidelines to conduct interviews include are presented below in *Figure 71*.

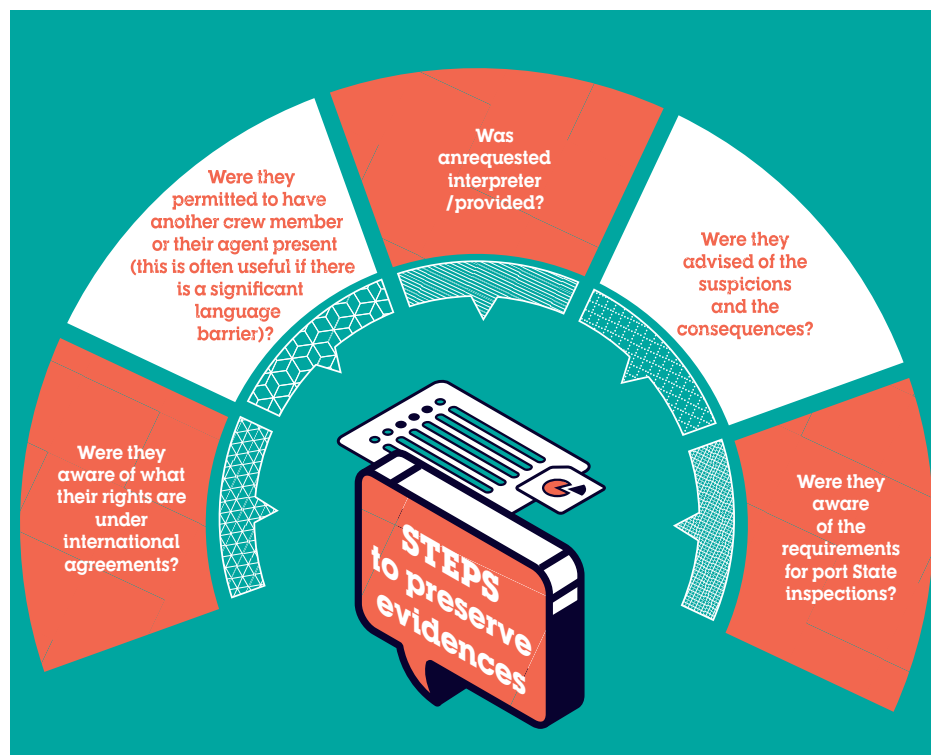

Source: IOTC, 2021

*Figure 71: Steps to preserve evidences*

Witness statements should be prepared, and the original copies of all witness statements should be in the correct form and signed. All witness statements must be read, checked against a set of questions (*Figure 72*).

## Port State measures

Procedures for the implementation of the Indian ocean Tuna Commission

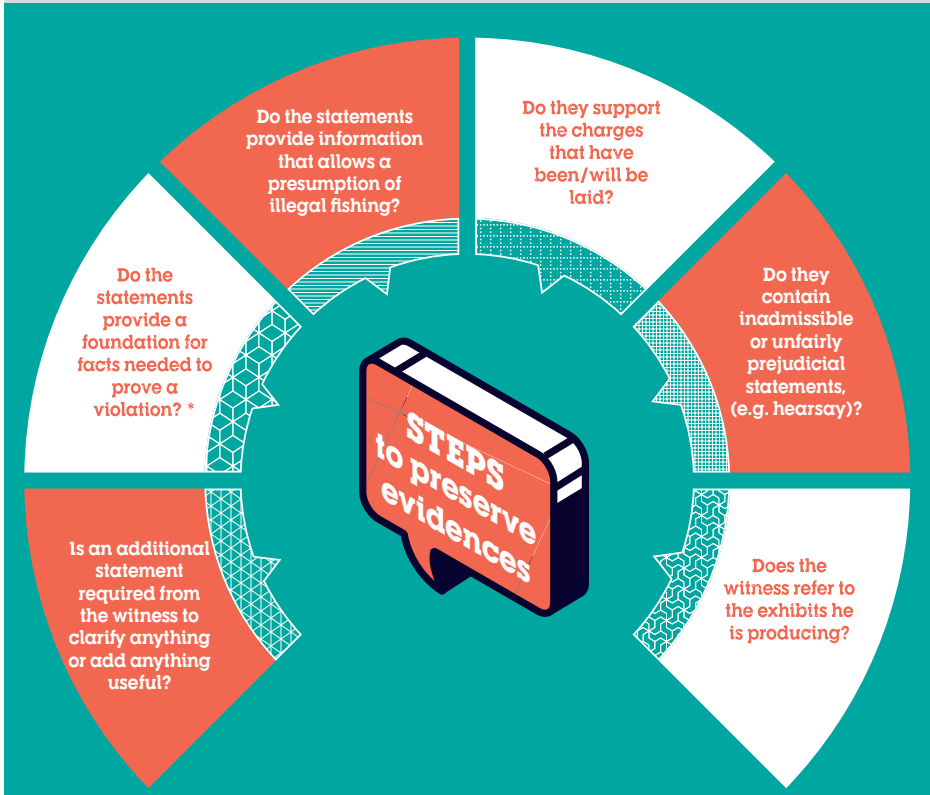

Source: IOTC, 2021

\* Some Fisheries Acts provide that 1) if an officer suspects any fish to which the charge relates were taken (illegally) in a particular area of waters; 2) he/she gives evidence of the grounds for the suspicion; 3) the court thinks the suspicion reasonable, then, in the absence of proof to the contrary, the fish are deemed to have been taken illegally.

Figure 72: Steps to preserve evidence

Any notes taken and other evidence collected by the inspectors will be vital to support the recordings and witness statements.



## CHAPTER 3



# PROCEDURES

### Implementing the IOTC PSMR

- Advance request to enter port
- Risk Assessment, port entry authorised or denied
- Standard Operating Procedures for on board inspection in port
- Monitoring landing and transshipment in port
- Procedures for following up and information sharing

*This chapter provides the key procedures and outputs required to implement the IOTC PSMR.*

*The first section outlines the requirements for advance requests by a vessel to enter port. It describes a risk assessment process that should be followed for each request and explains documents required by the IOTC PSMR and e-PSM system to be used in the process. The outcome is expected to provide a guide to the level of inspection and monitoring to be directed towards vessels granted permission to enter port.*

*The second section involves the practical conduct of inspections and monitoring the offloading of catches and is an integral part of implementing the port State measures. Suggested Standard Operating Procedures are provided that aim at co-ordinating procedures among different countries in the region.*

*The last section covers the subsequent reporting procedures and dissemination of reports and information to further strengthen the effectiveness of the IOTC PSMR objectives.*



# 5

## Advance Request to Enter Port

### 5.1.

Assessment of vessel  
request to enter port

---

### 5.2.

Risk assessment process

---

### 5.3.

Procedures to assess the AREP

---

### 5.4.

Risk Assessment Report and guide  
to complete the form "Checklist -  
Assessment of the AREP"

---

### 5.5.

Inspection briefing

---



The IOTC PSMR requires CPCs to designate and publicise the ports to which the foreign vessels may request entry. The IOTC maintains a list of designated ports, IOTC maintains a list of such ports, and CPCs must ensure they have sufficient capacity to conduct inspections at the designated ports.

An advance request to enter port must be made by vessels to enter designated ports (using the AREP form in Annex 1 of the PSMR) at least 24 hours before entering into port or immediately after the end of the fishing operations, if the time distance to the port is less than 24 hours and the port State has enough time to examine the information. It sets up the procedure to research and verify a vessel's background and activities prior to being authorised to enter port.

Where the AREP shows sufficient proof that a vessel has engaged in IUU fishing or related activities in support of such fishing, in particular the inclusion of a vessel on an IUU Vessel List, the CPC must deny that vessel entry into its ports. However, entry may be authorised only for purposes of inspection and taking other actions at least as effective as denial of entry, and use of port is not permitted.

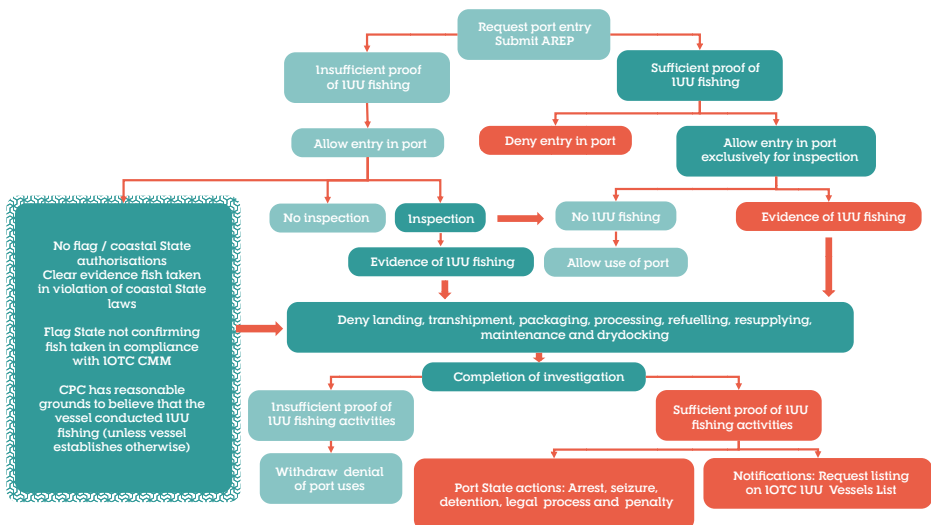

Figure 73: The process underlying port State measures  
– Advance Request to Enter Port –

## 5.1. Assessment of vessel request to enter port

The AREP provides the opportunity for port State authorities to examine and verify information provided by the vessel and determine whether the vessel, its owner and/or master have or may have engaged in IUU fishing activities. The decision to grant port entry and/or use of port is the right of the port State, which exercises complete sovereignty over its ports. The IOTC PSMR recognises this by providing that a vessel can enter a port only when it is authorised to do so by the port State. The decision to authorise port entry depends on the outcome of the assessment of the AREP.

The IOTC PSMR provides that each port State may adopt more stringent measures, including for port entry and use, than those agreed in the Resolution. CPCs may therefore require vessels to submit more information in the AREP than that required in ANNEX 1 of the IOTC PSMR, but nonetheless CPCs must observe the requirements of the IOTC PSMR concerning of use the e-PSM system, described above in section 3.3.

Assessment of the AREP by port State authorities is therefore a very important step in implementing the IOTC PSMR. The final decision to authorise or deny the entry into its port should be based on a detailed risk analysis. A "risk" factor" should be assigned to each vessel based on the information provided and additional information that may be obtained by authorities from the vessel's flag State, another coastal State, an RFMO or other network or organisation. The risk assessment process is described in the next section.

In the process to assess the AREP, two additional steps may be taken as described in the next section. These are integrated in the IOTC e-PSM system and involve sending forms for a Request for Additional Information (RAI) and Notification to a Fishing Vessel (NFV). The e-PSM system provides instructions for completing, previewing and receiving responses to the forms. It is essential that there is strong interagency cooperation, including clear and effective liaison and communications between the fisheries authority and others, such as authorities responsible for ports, customs, immigration, enforcement and legal matters. It must be clear that entry into port and use of port by fishing vessels and support vessels (carriers of fish that has not been landed, supply, refuelling etc) cannot take place without the decision or approval of the fisheries authority.

The vessels seeking entry must be required to wait outside the port until written notice has been provided by fisheries authorities to the vessel and the appropriate agencies.

*Entry into port and use of port (including port services) must be prohibited until cleared by fisheries authorities.*

Where a vessel claims *force majeure* or distress, fisheries authorities must be contacted immediately on receipt of such notice to advise whether: the claim is likely to be genuine; inspection should be effected prior to entry into port; the vessel should be allowed to enter port.

Because of the port State's complete sovereignty over the ports, it is not required to permit vessels claiming *force majeure* to enter port. For example, they may be refused entry where they pose threats to the port State's environment, security, health, good order or any other reason.

If it is agreed to allow port entry, the vessel must proceed to a designated port and authorities must be present on docking to verify the *force majeure* or distress. The vessel must be prohibited from using the port for any reason other than that claimed for *force majeure*, e.g. landings, crew exchange, provisioning or repairs, or other related activities.

## Port State measures

### Procedures for the implementation of the Indian ocean Tuna Commission

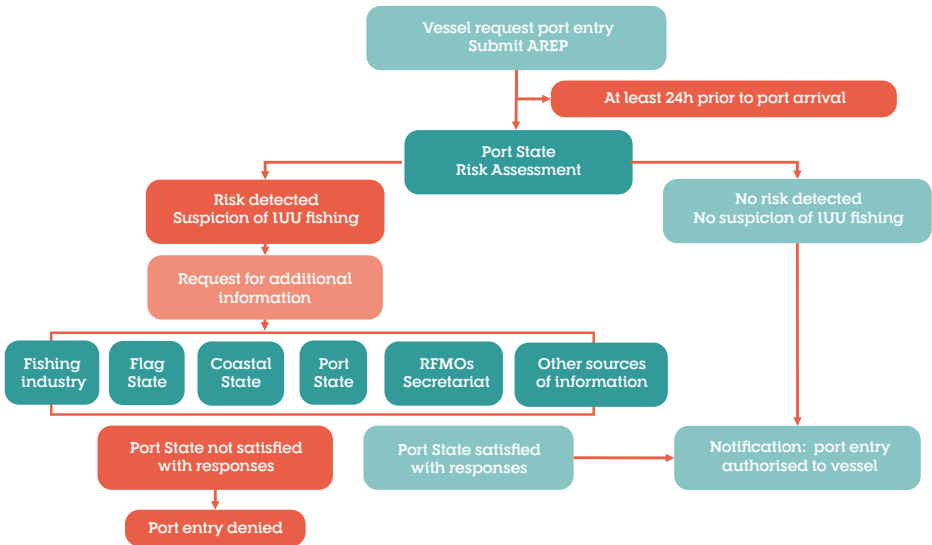

Source: IOTC, 2021

*Figure 74: Vessel advance request to enter port (AREP) and assessment and communication processes*

Four documents facilitate and formalise the assessment process for entry into port. They are in Appendices IV to VIII of this manual and in the e-PSM application, and are summarised in *Figure 74* and *Box 28*, and comprise:

- the Advance Request to Enter Port (AREP)
- the Checklist for assessing AREPs
- the request for additional information following a request to enter port (RAI-AREP)

## Box 28 | Port entry - Requirements and procedures

### 1. Vessel - Prior to Entry

*AREP for a designated report to be submitted (using IOTC e-PSM system as required) at least 24 hours prior to entering port or less if ceasing fishing provided sufficient time is given to review the AREP.*

*All required information must be provided truthfully.*

### 2. Fisheries/port authorities - Procedures Prior to Entry

*Review vessel AREP information, and may seek additional information via:*

- IOTC e-PSM form Request for Additional Information - AREP or via e-PSM;
- Flag State, coastal State, RFMOs, other sources;

### 3. AREP risk assessment.

### 4. Fisheries/port authorities - Decision

*Notify the vessel of its decision on the IOTC e-PSM Form "Notification to Fishing Vessel":*

- Allow entry, send authorisation for entry (to be presented at docking)
- Allow entry exclusively for inspection where there is sufficient proof of IUU fishing or related activities, and taking other actions as effective as denial of entry in combating IUU fishing and related activities, and deny use of port;
- Deny entry where there is sufficient proof of IUU fishing or related activities, including being on an RFMO IUU Vessel List, except that:

### 5. Communication/notification of decision on port entry

#### Port Entry denied

- Communicate to vessel or representative.
- Notify:
  - flag State;
  - as appropriate coastal States; and
  - IOTC Secretariat (which may inform other RFMOs).

*Deny use of port, take measures under national law.*

#### Port Entry authorised

*Communicate authorisation to vessel or representative.*

*Upon port entry, the vessel or representative must present the authorisation.*

### 6. Force majeure or distress

*May allow entry for force majeure or distress, exclusively for rendering assistance to persons, ships or aircraft in danger or distress*

## Port State measures

### Procedures for the implementation of the Indian ocean Tuna Commission

It is essential that there is a clear liaison and communications among port, customs, immigration and fisheries authorities to ensure that the fisheries authority controls access or denial of port entry where the port is the first point of landing for all fishing vessels and carrier vessels with fish onboard. The vessel must wait outside the port until written notice has been provided by the fisheries authority to the vessel and the appropriate agencies, e.g., port, customs and immigration. The vessel must not be permitted to use the port until cleared by fisheries.

Recall that "use of port" includes landing, transshipping, packaging, and processing of fish and use of other port services including, among others, refuelling and resupplying, maintenance and drydocking.

In cases where it has been agreed to allow port entry for *force majeure* or distress, and mindful that many vessels make false claims of *force majeure* in order to gain port access, fisheries authorities must be present on docking to verify the *force majeure* or distress before any use of port takes place, including crew exchange, provisioning or repairs. If the claim is valid, the vessel is only allowed to use the port for the purpose for which the *force majeure* was claimed.

## 5.2. Risk assessment process

The risk assessment process requires verifying components of the information provided in the AREP and any additional information received and assigning a level of risk to each of these to determine the likelihood of the vessel having been engaged in or associated with IUU fishing activities.

In determining risk levels and planning inspections for the vessels at high risk, CPCs should be mindful that the IOTC Resolution provides minimum levels of inspection of at least 5 percent of landings or transshipments in its ports during each reporting year, and the FAO Agreement sets priorities for inspection. The latter include vessels denied entry or use of a port, requests from other parties States or RFMOs and other vessels for which there are clear grounds for suspecting that they have engaged in IUU fishing activities.



Taking into account these levels and priorities, and to focus the efforts of available inspectors where they are likely to be most effective, the risk assessment process is essential for identifying high risk vessels where there is suspicion, sufficient proof or other evidence of IUU fishing activities.

Examples of criteria for identifying the vessel as high risk and therefore requiring further investigation or inspection, based on information in the AREP, are shown below in **Box 29**.

### Box 29 | Examples of criteria for identifying a vessel as high risk

Example of criteria	High risk vessel
<ul style="list-style-type: none"> <li><input type="checkbox"/> Vessel is not included in the IOTC Authorised Vessel Record (Res. 19/04)</li> <li><input type="checkbox"/> Vessel is on IOTC Authorised Vessel Record but has a record of IUU fishing activities and does not comply with the Resolution on Registered Vessels respecting actions by the flag State in such a case, e.g., change of beneficial ownership;</li> <li><input type="checkbox"/> Recent or frequent name changes</li> <li><input type="checkbox"/> Recent or frequent flag changes</li> <li><input type="checkbox"/> Recent or frequent change of ownership</li> </ul>	<ul style="list-style-type: none"> <li><input type="checkbox"/> Information is not provided by the vessel or is false, incorrect or misleading</li> <li><input type="checkbox"/> Efforts to communicate with the flag State not successful</li> <li><input type="checkbox"/> VMS/AIS records not available</li> <li><input type="checkbox"/> Information on the last port call cannot be verified</li> <li><input type="checkbox"/> Authorisation to tranship from or to a donor vessel not available;</li> <li><input type="checkbox"/> Declarations to tranship to or from a donor vessel are not available or incomplete</li> </ul>

## Port State measures

### Procedures for the implementation of the Indian ocean Tuna Commission

The "*Checklist - Assessment of advance request of entry in port*" (Appendix VI), is designed for internal use by the port State fisheries authority to keep track of the timing of actions and decisions taken during processing the requests. It also provides the basis for briefing the inspection team and advising them of the level of risk and where special attention needs to be focused during the inspection.

It has been complemented in the e-PSM application by a framework for a risk assessment report (RAR). However, the senior official (e.g. Principal Secretary) has the discretion to define the criteria used at national level and to take a decision.

As noted above, after submission of an AREP and where more information is needed, the e-PSM system provides a form for a "*request for additional information*" and it explains the process for completing and reviewing the form and receiving responses (See Appendix VIII).

Similarly, where a vessel's AREP does not meet the above criteria and there is no cause for suspicion of IUU fishing activities, the vessel may be given a low risk profile, particularly if it provides verifiable information such as that provided in **Box 30**.

### Box 30 | Examples of criteria for identifying a vessel as low risk

#### Example of criteria for

#### Low risk vessel

- Flag State authorisation to engage in fishing or fishing related activities;
- Registration on the IOTC Record of Authorised Vessels with all details listed;
- Valid and applicable authorisation to engage in fishing or fishing related activities required by a coastal State in respect of areas under the national jurisdiction of that State;

- Logbook information indicating that the fish on board conforms to the applicable authorisation on board,
- The vessel and owner details are in the IOTC Record of Authorised Vessels

Source: IOTC, 2021

Following the assessment of the AREP (*Figure 75*) and depending on the perceived risk, the decision is communicated back to the vessels on the form "Notification to fishing vessels" via the IOTC in the e-PSM system (Appendix VII).

The risk assessment can lead to the following outcomes (*Figure 76*):

- sufficient proof of IUU fishing activities:
  - deny port entry;
  - allow port entry but exclusively for inspection and must deny any other use of port;
  - where legitimate force majeure is claimed, allow port entry exclusively for the purpose for which it was claimed and deny any other use of port.

## Port State measures

Procedures for the implementation of the *Indian ocean Tuna Commission*

- No evidence or insufficient proof of IUU fishing activities:
  - Allow port entry, where inspection may or may not take place.

When a vessel is denied port entry the port State authorities must immediately notify the vessel of such decision and communicate the decision to the vessel's flag State, relevant coastal States, the IOTC and relevant international organizations, as well as other relevant States that may have been influential in the decision (**Box 30**).

### Box 31 | Requirement / procedure to be followed by the port State for a vessel denied port entry

Mandatory denial of use of port for a vessel that has been authorised to enter port without restrictions, but has not necessarily been inspected where:

- The vessel is not registered on the IOTC RAV or is on the IOTC IUU Vessel List.
- The vessel does not hold an authorisation to engage in fishing or related activities as required by its flag State.
- The vessel does not hold an authorisation to engage in fishing or related activities required by a coastal State in areas under its jurisdiction or there is clear evidence that fish was taken contrary to coastal State requirements.
- The flag State does not confirm, on request, within a reasonable time that the fish was taken in accordance with relevant RFMO requirements.
- There are reasonable grounds to believe that the vessel was otherwise engaged in IUU fishing or related activities, unless the vessel can establish that it was:
  - acting in a manner consistent with relevant IOTC resolutions; or
  - in the case of provision of personnel, fuel, gear and other supplies at sea, the vessel that was provisioned, at the time of provisioning, was a vessel that had not engaged in IUU fishing.

Port services must not be denied:

- where they are essential to the health of the crew or the safety of the vessel, provided that these needs are proven; or
- where appropriate, for the scrapping of the vessel.

Action/notification:

- Prompt notification of the decision to deny use of port must be given to the flag State and other involved port State agencies and, as appropriate, relevant coastal States, IOTC or other relevant RFMOs and international organizations.
- Report the IUU activity to IOTC for inclusion on the IUU Vessel List.

Withdrawal of denial of use of port:

- Denial of use of port may be withdrawn if there is sufficient proof that the grounds were inadequate or erroneous or no longer apply. Notification of withdrawal must be given to those included in the notification of denial of port use.

## Port State measures

Procedures for the implementation of the Indian ocean Tuna Commission

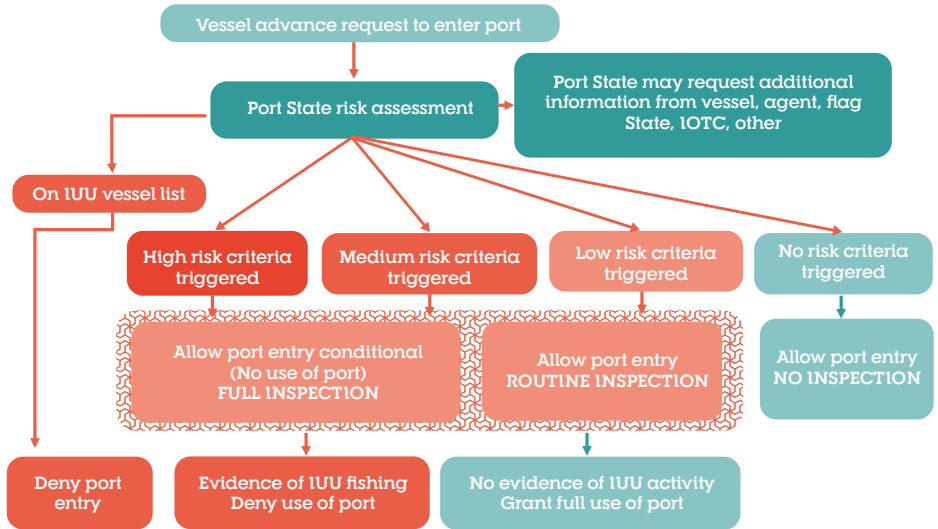

Source: IOTC, 2021

Figure 75: Risk assessment process

Following the risk assessment process (Figure 75), if entry into the port is authorised and the port State decides to inspect the vessel, directions should be given on the inspection to be conducted on board the vessel. Normally, inspections target the following items in Figure 76.



Source: IOTC, 2021

Figure 76: Main target points of the inspection in port

The IOTC PSMR requires:

- CPCs to carry out inspections of at least 5 percent of landings or transshipments in its ports during each reporting year; and
- inspectors to make all possible efforts to avoid unduly delaying a vessel and ensure that the vessel suffers the minimum interference and inconvenience and that degradation of the quality of the fish is avoided.

The port CPC may invite inspectors of other CPC to accompany their own inspectors and observe the inspection of landings or transshipment operations of fishery resources caught by fishing vessels flying the flag of another CPC.

### 5.3. Procedures to assess the AREP

This section is aimed at providing a detailed guide to the process to be followed in the assessment process of the AREP.

#### **A** Name of the fishing vessel

Recommended source of information:

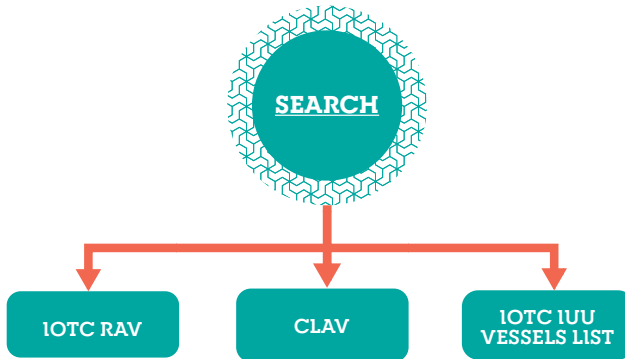

Figure 77: Recommended sources of information

Source: IOTC, 2021

Search IOTC Online Tools for vessel details [<https://iotc.org/vessels>], to obtain access to vessels information.

Or consult the Consolidated List of Authorized Vessels (CLAV) Online tools: <http://clav.iotc.org>

Note: vessels from Taiwan, Province of China, are not on the IOTC web site, consequently request information from IOTC Secretariat at [IOTC-authorized.vessels@fao.org](mailto:IOTC-authorized.vessels@fao.org)

Contact details are presented in [Table 12](#).



Table 12 - Contact details for IUU Vessel Lists

<b>IOTC:</b> <a href="http://www.iotc.org/English/iuu/search.php">http://www.iotc.org/English/iuu/search.php</a>
<b>CCSBT:</b> <a href="https://www.ccsbt.org/sites/default/files/userfiles/file/docs_english/CCSBT_IUU_Vessel_List.pdf">https://www.ccsbt.org/sites/default/files/userfiles/file/docs_english/CCSBT_IUU_Vessel_List.pdf</a>
<b>IATTC:</b> <a href="http://www.iatcc.org/VesselRegister/IUU.aspx?Lang=en">http://www.iatcc.org/VesselRegister/IUU.aspx?Lang=en</a>
<b>NEAFC:</b> <a href="http://www.neafc.org/blist">http://www.neafc.org/blist</a>
<b>ICCAT:</b> <a href="http://www.iccat.int/en/IUU.asp">http://www.iccat.int/en/IUU.asp</a>
<b>CCAMLR:</b> <a href="https://www.ccamlr.org/en/compliance/illegal-unreported-and-unregulated-iuu-fishing">https://www.ccamlr.org/en/compliance/illegal-unreported-and-unregulated-iuu-fishing</a>
<b>WCPFC:</b> <a href="https://www.wcpfc.int/wcpfc-iuu-vessel-list">https://www.wcpfc.int/wcpfc-iuu-vessel-list</a>
<b>Norway:</b> <a href="http://www.fiskeridir.no/english/fisheries/norwegian-black-list">http://www.fiskeridir.no/english/fisheries/norwegian-black-list</a> (Maintains α "Black List" of IUU vessels)

## Port State measures

Procedures for the implementation of the Indian ocean Tuna Commission

### Target information

The fields in the AREP (see [Table 13](#)) must be verified.

*Table 13 - The fields to be verified in the AREP*

	Flag State
	International Radio Call Sign
	Certificate of registry ID
	VMS type and Fisheries Control Centre
	Type of vessel
	Vessel owner(s)
	IOTC number
	Fishing gear specified in the authorisation to fish

History of vessel: IOTC record of authorised vessels will provide details in four categories of information: vessel identification, administrative details, vessel characteristics and history of the vessel.

A search for a vessel on an RFMO list/record of authorised vessels may not produce a result. This may be due to the spelling of the vessel name or an administrative reason. It is then advisable to contact the organisation (e.g. RFMO) directly with the available information from the AREP.

## Verification process

If the vessel is not on IOTC RAV verify if it is present on the authorised vessel (*Table 14*) list of another RFMO.

*Table 14 - Checks if not on IOTC Record of Authorised Vessels*

	Previous names - in cases where there have been frequent name changes (check all past names against IUU Vessel Lists)
	Frequent flag change
	Use IMO number (when available) to cross check other lists
	Use the vessel's IRCS to search and cross check

*Note that a vessel can appear on more than one IUU Vessel list*

Where a vessel was previously on an IUU Vessel List and has been re-flagged it is essential to contact the flag State for verification of the new registration and to query if they were aware of the vessel's IUU history or change of name (*Box 32*). It is important to check if there was a change of ownership with the re-flagging or if the previous owners still have shares in the vessel.

Record the response received from the organisation. Should the response still be inconclusive this would indicate a possibility of the vessel having attempted to use a false name. In this case the flag State should be contacted for comment or further verification of the vessel's credentials.

Failure of a flag State to respond would place such a vessel into a high-risk category. Should any of the other information provided in the AREP be found to be incorrect or unverifiable this would be sufficient evidence to refuse port entry to the vessel.

## Port State measures

Procedures for the implementation of the Indian ocean Tuna Commission

### Box 32 | Example of change of name of fishing vessel

An IUU vessel known as *Black Moon* had previous names *Dorita*, *Eolo*, *Magnus*, *Thule* and *Red Moon*. This vessel was listed under different names on different IUU Vessel Lists. It used a new name "*Ina Maka*" to gain port entry. However it still displayed the international radio call sign (IRCS) for the vessel registered as the "*Black Moon*". (Source COLTO IUU Vessel Listing).

### **B** IMO number

Recommended source of information (Figure 78).

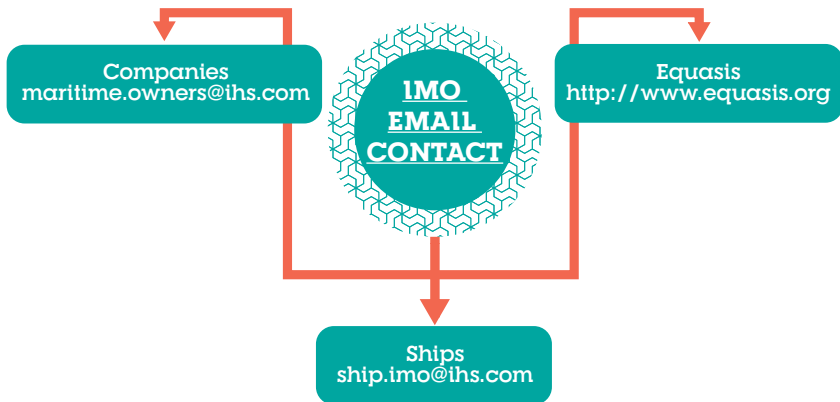

Figure 78: Sources of information for IMO number

Equasis is a tool aimed at reducing substandard shipping. It provides safety related information on ships and companies.

Web site: <http://www.equasis.org>

Fairplay operates a service following receipt of a completed IMO number Request Form.

Contact: IHS Fairplay, Lombard House, 3 Princess Way Redhill, Surrey RH1 1UP United Kingdom.

Telephone: +44 1737 379043.

Web site: <http://www.imonumbers.lrfairplay.com/>

Email: [data-audit@lrfairplay.com](mailto:data-audit@lrfairplay.com)

### Target information

Provide details for verification of following fields in the request form ([Table 15](#)).

*Table 15 - IMO number: target information & verification process*

	Port and date of last port call
	Current flag State
	International Radio Call Sign
	Vessel owner(s)
	Previous name of the vessel
	Type of vessel
	Vessel contact information
	Certificate of registry ID
<p><i>Note: AIS may also provide information of the vessels last port of call and its current location.</i></p>	

An IMO number provides information on the vessel specifications, vessel contact information, flag State, owner's details, history of change of ownership and re-flagging. The IMO number is assigned to the vessel at the time of construction and will not change despite vessel modifications or change of ownership.

## Port State measures

Procedures for the implementation of the Indian ocean Tuna Commission

### Verification process

Provide details for verification of following fields in the request form (*Table 16*).

*Table 16 - IMO number: verification*

	Port and date of last port call
	Current flag State
	International Radio Call Sign
	Vessel owner(s)
	Previous name of the vessel
	Type of vessel
	Vessel contact information
	Certificate of registry ID

## C Fishing authorisations

Recommended source of information:

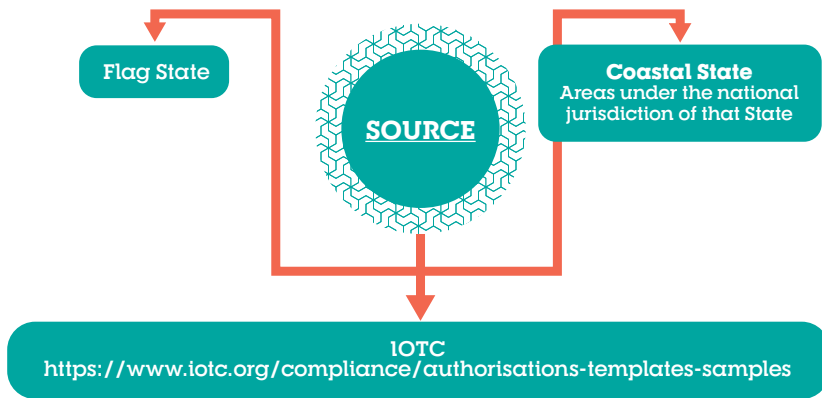

Source: IOTC, 2021

Figure 79: Sources of information for fishing authorisations

Communicate with entities that have provided the vessel with an authorisation to fish (ATF) and / or tranship (from flag State) or fishing or transshipment license issued by a coastal State.

Search on the IOTC web site for template ATF, name of the Competent Authority, name and contact of personnel of the Competent Authority, signature of the personnel of the Competent Authority, official stamp of the Competent Authority (Figure 79).

<https://iotc.org/compliance/authorizations-templates-samples>

[CPCs request login at [IOTC-Authorised-Vessels@fao.org](mailto:IOTC-Authorised-Vessels@fao.org) ]

## Port State measures

### Procedures for the implementation of the Indian ocean Tuna Commission

#### Target information

Request details on authorisation issued to the vessel with respect to the information in **Table 17**.

*Table 17 - Fishing authorisations: target information & verification process*

	Identifier
	Issuing authority
	International Radio Call Sign
	Authorised period valid
	Authorised fishing area
	Authorised target species
	Gear
	VMS records

If a vessel has fished within areas under national jurisdiction of another country, request details of the authorisation issued by that country and repeat the process.

#### Verification process

Verify with information provided in **Table 18**.

*Table 18 - Fishing authorisations: verification*

	Fishing authorisation issued by authorised officers of the flag State
	Authorised fishing area compared with where the vessel has reportedly fished
	Authorised fishing gear
	Validity of fishing authorisation (Date to/from, annualy)
	Authorised target species (species or group of species)
	VMS requirements (reporting frequency, manual reporting)



Any discrepancies noted in an ATF would be a cause for suspicion. Should there be suspicion of the validity of the flag State authorisation to fish provided by the vessel in the AREP then contact the relevant authorities of the flag State and request details with respect to **Table 19**.

*Table 19 - Fishing authorisation: verification in the case of suspicion*

	Identifier (national serial number of the ATF/fishing license)
	Authorised period valid (ATF/fishing license)
	Authorised fishing area (ATF/fishing license)
	Fishing Gear
	Issuing authority (ATF/fishing license)
	International Radio Call Sign
	Authorised target species
	VMS records

## D

### **Relevant transshipment authorisation(s)**

#### **Recommended source of information:**

Verify information regarding the transshipment authorisation issued by the fisheries authority of the flag State.

IOTC web site for list of authorised Carrier vessels: <http://www.iotc.org>. Select list of authorised Carrier vessels, Select "Search for carrier vessels only" and select all county flag and all vessel type, then click search".

## Port State measures

### Procedures for the implementation of the Indian ocean Tuna Commission

#### Target information

Verify vessel details ([Table 20](#)).

*Table 20 - Transshipment authorisations: target information on vessel details*

	Vessel name
	IOTC record number
	National Registration number
	Authorisation status
	Flag State
	International Radio Call Sign

Verify vessel characteristics, including vessel history ([Table 21](#)).

*Table 21 - Transshipment authorisation: target information on vessel history*

	Type of vessel
	Length of vessel
	Tonnage of vessel
	Gear used by vessel
	Owner of vessel
	Operator of vessel

*Note: If the carrier is not listed on the IOTC RAV, check other RFMO lists of authorised vessels. Carriers pass through other RFMO areas of competence and may be tempted to use the excuse that they are registered in another RFMO and thought they could carry out operations in the IOTC area of competence as well.*

## Target information (Table 22)

Table 22 - Transshipment authorisations: target information & verification process

	Verify the validity & the detail of the competent authority issuing the transshipment authorisation
	Note if the vessel is included on IOTC list of authorised Carrier vessels
	Cross reference and verify information with AREP
	Cross check with transshipment authorisation to see whether area of transshipment authorisation matches TRX location
	Check dates with transshipment validity

**E**

### Transshipment information concerning donor vessels

Recommended source of information:

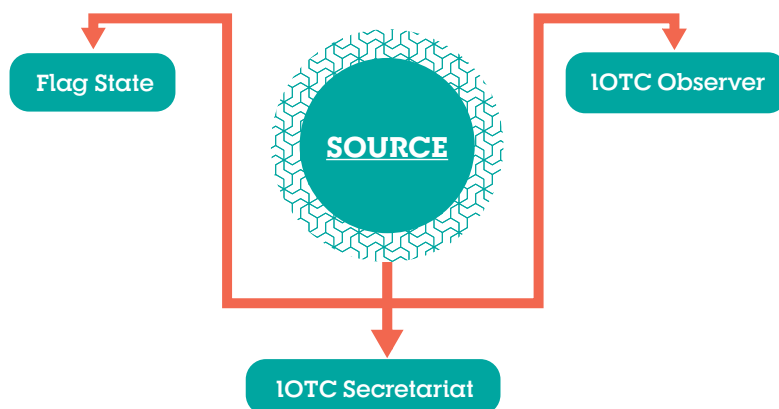

Figure 80: Sources of transshipment information

Where there is doubt or if the information is not provided by the flag State or copies are not made available with the AREP, request information from the IOTC Secretariat ([IOTC-transshipment@fao.org](mailto:IOTC-transshipment@fao.org)) and check the identity and

## Port State measures

### Procedures for the implementation of the Indian ocean Tuna Commission

information with the IOTC observer assigned to the vessel or the observer provider (*Figure 80*).

### Target information (*Table 23*)

*Table 23 - Transhipment authorisation: target information*

	Original transhipment authorisation provided to the donor vessels
	Transhipment declarations from donor vessels
	Transhipment declarations from receiving vessel

### Verification process

In case of carrier vessel calling into port, it is recommended that the port State verify the transhipment declarations as per *Table 24*.

*Table 24 - Transhipment authorisation: verification*

	Verify that the declarations are on board the carrier vessel and have been communicated to the IOTC secretariat
	Verify detail of transhipment declaration: area, species, date
	Verify transhipment declarations have been signed by the IOTC observer assigned to the carrier vessel

## F Total catch on board

Recommended source of information (Figure 81).

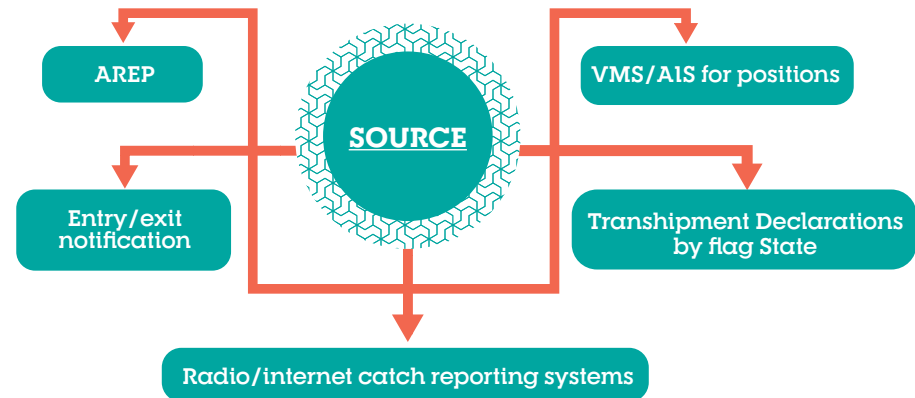

Source: IOTC, 2021

Figure 81: Sources of transhipment information

## Target information (Table 25)

Table 25 - Total catch on board: target information

	<p>The total quantities of fish on board per species and product codes.</p> <p>The areas of catch for each species: high sea and waters of coastal State</p>
---	--

## Port State measures

Procedures for the implementation of the Indian ocean Tuna Commission

### Verification process (Table 26)

Table 26 - Total catch on board: verification

	Catch area with authorisations to fish
	Verify species match those on the authorisation to fish
	For shark fins note percent to total weight of shark trunks
	Total catch does not exceed allowable catch on authorisation
	Check by-catch limit to total weight of target species

## 5.4. Risk Assessment Report and guide to completing the "Check list - Assessment of the AREP" form

The Risk Assessment Report (RAR) form in the IOTC e-PSM system was designed to update and facilitate electronic use of the Checklist for assessment of AREPs, described below. However, the Checklist is still available for manual use if needed.

The RAR and the Checklist are designed for internal use by the port State to record relevant:

- actions (e.g. receipt of AREP);
- information (e.g. vessel listed on IUU or authorised vessel lists); and
- communications (e.g. with flag State, vessel, other).

in the process of deciding whether to grant a vessel port entry. The outcomes provide the basis for briefing the inspection team and advising them of the level of risk and where special attention needs to be focused during the inspection.

The RAR and the Checklist both have fields for receipt of an AREP, investigations of relevant RFMO vessel lists (IUU, authorised vessels) and valid flag State authorisations to fish. Other sources of intelligence are also invited, and the list is not exhaustive in either case.

However, they differ in some respects because the RAR fields also include:

- vessel identifiers mismatch;
- vessel particulars;
- previous denial of port entry;
- active vessel;
- serious misreporting on previous catch declaration;
- flag history;
- VMS on board;
- owner history;

## Port State measures

### Procedures for the implementation of the Indian ocean Tuna Commission

- previous IUU Vessel Listing;
- owner on IUU Vessel List;
- previous AREP in this port;
- no reply to RAI;
- license to fish in coastal State waters;
- at sea transshipments;
- invalid flag State authorisations to fish.

The Checklist fields include the following, not on the RAR form:

- transshipment authorisations and information on donor vessels;
- recommendations on port access and inspections;

In completing the forms, it is encouraged to add all relevant information even where a specific field may not be provided.

The check list in *Table 27* is available in Appendix VI. The actions and instructions to complete the form are described below for each field.

#### General completion instructions:

- Date of actions:
  - Record a date when it was addressed using format DD/MM/YYYY.
  - Where an action took more than one day to complete record the start and end date of the process.
  - Where a request for additional information is made record the date when the request was made, note the means of transmitting the request for information, i.e. fax, email, telephone call. Record the date that a response was received back from the request.
- Potential irregularities, comments, results of actions:
  - Record in free text the result of the research or verification process. Where the information is inconclusive or there is suspicion of falsified or inconclusive information this must be highlighted for further action or investigation.



Table 27 - Check-list Assessment of AREP

		<b>CHECK LIST</b> <b>ASSESSMENT OF ADVANCE REQUEST OF ENTRY IN PORT</b>	
<b>Name of officer</b>	Record the name of the fisheries officer	<b>ID</b>	Record the identification number of the fisheries officer
Items/Actions	Date of Action	Potential irregularities/Comments/Results of Actions	
<b>AREP Received</b>	...../...../.....	<p>Record the date and time that the AREP was received.</p> <p>Note:</p> <p>→ By what means it was conveyed, email, fax or hard copy.</p> <p>→ Did it come direct from the vessel, through an agent or via the vessels fishing authority or any other body.</p> <p>Tick the appropriate box (√)</p>	
<b>Vessel name</b>	Record the name of the vessels		
<b>Flag</b>	Record the flag		
<b>IOTC Number</b>	Record the IOTC number		
<input type="checkbox"/> 1 <sup>st</sup> port call <input type="checkbox"/> Occasional <input type="checkbox"/> Regular			
<b>Port and date of last port call:</b>			
Record the date, and name or code of last port call			
<b>Purpose of call:</b>	<input type="checkbox"/> Landing <input type="checkbox"/> Transhipping <input type="checkbox"/> Packaging <input type="checkbox"/> Processing of fish <input type="checkbox"/> Refuelling <input type="checkbox"/> Resupplying <input type="checkbox"/> Maintenance <input type="checkbox"/> Drydocking <input type="checkbox"/> Force majeure		Tick the purpose of the call (√).

## Port State measures

Procedures for the implementation of the Indian ocean Tuna Commission

<p><b>Verification on IUU Vessel Lists</b></p> <p>IOTC: <a href="http://www.iotc.org/English/iuu/search.php">www.iotc.org/English/iuu/search.php</a>          ICCAT : <a href="http://www.iccat.int/en/IUU.asp">www.iccat.int/en/IUU.asp</a>          CCSBT : <a href="http://www.ccsbt.org/site/authorised_vessels.php">www.ccsbt.org/site/authorised_vessels.php</a>          CCAMLR  <a href="http://www.ccamlr.org/en/compliance/non-contracting-party-iuu-vessel-list">www.ccamlr.org/en/compliance/non-contracting-party-iuu-vessel-list</a>          IATTC <a href="http://www.iattc.org/VesselRegister/IUU.aspx?Lang=en">www.iattc.org/VesselRegister/IUU.aspx?Lang=en</a>          WCPFC  <a href="http://www.wcpfc.int/vessels#IUU">www.wcpfc.int/vessels#IUU</a>          NEAFC  <a href="http://www.neafc.org/blist">www.neafc.org/blist</a>          OPRF (Maintains links to four of the major tuna RFMO's)  <a href="http://www.tuna-org.org/vesselneg.htm">www.tuna-org.org/vesselneg.htm</a>          Norway (Maintains a "Black List" of IUU vessels)  <a href="http://www.fiskeridir.no/english/ fisheries/norwegian-black-list">www.fiskeridir.no/english/ fisheries/norwegian-black-list</a></p>	<p>---/---/---</p>	<p>On IUU Vessel List : <b>YES</b> <input type="checkbox"/> <b>NO</b> <input type="checkbox"/></p> <p>Process followed:</p> <p>→ to verify if the name of the vessel is associated with any IUU Vessel List;</p> <p>→ record web sites consulted.</p> <p>First conduct an electronic search on all available IUU Vessel Lists using the vessels name, IRCS and IMO number.</p> <p>If the vessel name does not reflect on either the IOTC positive list or any of the IUU Vessel Lists contact flag State and check if it is on the positive list of another organisation.</p> <p>In terms of IOTC Resolution 16/11 – Paragraph 7, a request for additional information can be sent to either / or both the agent/vessel and flag State.</p> <p>Check if the vessel has any recorded name changes and re-check the previous names for IUU Vessel Listing.</p> <p>Where a vessel was previously on an IUU Vessel List and has been re-flagged it is essential to contact the flag State for verification of the registration and to query if they were aware of the vessels IUU history. It is important to check if there was a change of ownership with the re-flagging or if the previous owners still have shares in the vessel.</p>
<p><b>Verification on Positive Lists</b></p>	<p>---/---/---</p>	<p>On positive list : <b>YES</b> <input type="checkbox"/> <b>NO</b> <input type="checkbox"/></p> <p>Record YES if it is registered on a recognised positive list.</p> <p>Note: vessels from Taiwan Province of China, are not on the IOTC web site, consequently request information from IOTC Secretariat at <a href="mailto:authorised.vessels@iotc.org">authorised.vessels@iotc.org</a></p>

<b>In case not on positive lists, contact with (✓):</b>		
<input type="checkbox"/> flag State <input type="checkbox"/> others _____	---/---/---	When a vessel does not appear on a positive list and is also not recorded on an IUU Vessel List then additional information can be requested from the flag State or directly from the vessel or its owners.
<b>Receipt of response</b>	---/---/---	Comment on response and list if on another positive list or reason provided for it not being listed.
<b>Flag State Authorisation to fish</b>	---/---/---	Verify details on the ATF(s) issued to the vessel (if available).  In the event that the vessel has not previously entered the port and there is no prior history of the vessel having been inspected in the port it would be advisable to contact the flag State fishing authorities and request a copy of the authorisation to fish issued to the vessel. The contents of this can be crosschecked with the information provided by the vessel in its AREP.  Where the vessel indicated that it was fishing with an fishing license from a coastal State then these documents will also be scrutinised for authenticity. Any discrepancies noted would be a cause for suspicion.
<b>In case not provided, contact with:</b>	---/---/---	If the vessel does not provide a copy of an authorisation to fish in the AREP or following a further request to the vessel for this information; then record if contact was attempted or made with the flag State or the authorities of coastal States.
<input type="checkbox"/> flag State <input type="checkbox"/> coastal State		
<b>Receipt of response</b>	---/---/---	Record the main aspects of the response, comments on completeness and timeliness.

## Port State measures

### Procedures for the implementation of the Indian ocean Tuna Commission

<p><b>Flag State Authorisation to fish</b></p>	<p>---/---/---</p>	<p>Verify details on the ATF(s) issued to the vessel (if available).</p> <p>In the event that the vessel has not previously entered the port and there is no prior history of the vessel having been inspected in the port it would be advisable to contact the flag State fishing authorities and request a copy of the authorisation to fish issued to the vessel. The contents of this can be crosschecked with the information provided by the vessel in its AREP.</p> <p>Where the vessel indicated that it was fishing with an fishing license from a coastal State then these documents will also be scrutinised for authenticity. Any discrepancies noted would be a cause for suspicion.</p>
<p><b>In case not provided, contact with:</b></p> <p><input type="checkbox"/> flag State <input type="checkbox"/> coastal State</p>	<p>---/---/-----</p>	<p>If the vessel does not provide a copy of an authorisation to fish in the AREP or following a further request to the vessel for this information; then record if contact was attempted or made with the flag State or the authorities of coastal States.</p>
<p><b>Receipt of response</b></p>	<p>---/---/-----</p>	<p>Record the main aspects of the response, comments on completeness and timeliness.</p>
<p><b>Transhipment authorisation</b></p>	<p>---/---/-----</p>	<p>Verification of information for transhipment authorisations with the relevant fisheries organisation, flag State or coastal State will follow the same procedure as verifying the ATF.</p> <p>In addition the carrier vessel should be cross checked to see if they appear on the RFMO positive list or IUU Vessel List. The carrier should be on the IOTC list of registered vessels to operate in the IOTC Are of Competence.</p>

<b>In case not provided, contact with:</b>		Details of the response received from the organisation must be recorded. Should the response still be inconclusive this would indicate a possibility of the vessel having attempted to use a false name. In this instance the flag State should be contacted for comment or further verification of the vessels credentials. In the event of the flag State not responding it would place such a vessel into a high risk category. Should any of the other information provided in the AREP be found to be incorrect or unverifiable this would be sufficient evidence to refuse port access to the vessel.
<input type="checkbox"/> flag State <input type="checkbox"/> other _____	___/___/___	
<b>Receipt of response</b>	___/___/___	Record the main aspects of the response, comments on completeness (Identifier, issuing authority and validity) and timeliness.
<b>Transshipment information on donors vessels</b>	___/___/___	Verification of information for transshipment on donors vessels: flag, catch area, species  The donor vessels should be cross checked to see if they appear on the positive list or IUU Vessel List of a relevant fisheries organisation.
<b>Donors vessels not on positive list, contact with:</b>		When a donor vessel does not appear on a positive list and is also not recorded on an IUU Vessel List then additional information can be requested from the flag State or directly from the vessel or its owners.
<input type="checkbox"/> flag State <input type="checkbox"/> other _____	___/___/___	
<b>Receipt of response</b>	___/___/___	Record the main aspects of the response, comments on completeness (Identifier, issuing authority and validity) and timeliness.

## Port State measures

Procedures for the implementation of the Indian ocean Tuna Commission

<p><b>Request of additional information</b></p>	<p>Yes <input type="checkbox"/>          ___/___/___</p> <p>Response received:          ___/___/___</p> <p>No <input type="checkbox"/></p>	<p><input type="checkbox"/> Coastal State authorisation to fish (specify): _____</p> <p><input type="checkbox"/> Flag State authorisation to fish</p> <p><input type="checkbox"/> Flag State authorisation to tranship</p> <p><input type="checkbox"/> Fishing logbook from ___/___/___ to ___/___/___</p> <p><input type="checkbox"/> Certificate of registry of the fishing vessel</p> <p><input type="checkbox"/> IOTC transhipment declarations</p> <p><input type="checkbox"/> VMS record from ___/___/___ to ___/___/___</p> <p>Copy of vessel master <input type="checkbox"/> Passport <input type="checkbox"/> National ID</p> <p><input type="checkbox"/> Others documents: (specify): _____</p> <p><i>Tick (✓) what information you have requested.</i></p>
<p><b>Recommendations on port access</b></p>	<p>___/___/___</p>	<p><input type="checkbox"/> Allow entry and use of facilities</p> <p><input type="checkbox"/> Allow entry but no use of port facilities, until cleared by full port inspection (If not cleared deny use of port facilities and proceed with PSM measures to contact flag State and other appropriate coastal States and IOTC Secretariat).</p> <p><input type="checkbox"/> Deny entry</p> <p><i>Tick (✓) where appropriate.</i></p>
<p><b>If entry authorised, recommendations for inspections</b></p>	<p>___/___/___</p>	<p><input type="checkbox"/> Flag State authorisation to fish/TRX authorisation</p> <p><input type="checkbox"/> Flag State authorisation to tranship</p> <p><input type="checkbox"/> Fishing logbook</p> <p><input type="checkbox"/> Fishing gear and associated equipment</p> <p><input type="checkbox"/> Catch on board</p> <p><input type="checkbox"/> Other document: _____</p> <p><i>Tick (✓) where appropriate depending of the inconsistencies found during the assessment of the AREP to provide the basis for the briefing of the inspection team and where special attention needs to be focused during the inspection.</i></p>

## 5.5. Inspection briefing

As part of the inspectors "Tool Kit" and to assist in preparation for the inspection, a detailed brief should be prepared for the inspection team that will conduct the inspection. This briefing will assist in guiding inspectors to specific areas where there are likely to be discrepancies in the information that was provided in the AREP.

Depending on the level of inspection required, i.e. *full inspection including documents, gear and catch or routine inspection of documents and monitoring off-loaded catch*, the briefing allows the inspection team to prepare their equipment and entering enclosed or sub-zero temperature compartments during the operation. The brief should include the elements in [Table 28](#).

## Port State measures

### Procedures for the implementation of the Indian ocean Tuna Commission

Table 28 - Elements of the inspection briefing

	Copies of the Advance Request to Enter Port (AREP) submitted by the vessel
	Copies of the request for additional information following a request to enter port (e-PSM form)
	Copies of the RAR or the Checklist for AREP
	Copies of the notification to fishing vessel (NFV e-PSM form)
	The mandate authorising the inspection, referencing the country's legislation and relevant IOTC Resolutions
	Summary of investigation from the risk assessment, noting specifically any information that should be verified and receive more attention in the inspection process
	Copies of the transshipment declarations where these are available
	Copies of the VMS/AIS records where these are available
	List of fishing gears and quantities expected to be present on board
	List of the product codes and weight of the target and by-catch species that the vessel declared on board
	tables and formulas for calculating volumetric measurements of fish holds



# 6

## Standard Operating Procedures - on board inspection of vessel

### 6.1.

Pre-boarding process

---

### 6.2.

On board inspection - Standard Operating Procedures

---

### 6.3.

Monitoring landing and transhipments in port

---

### 6.4.

Follow up procedures, actions and requirements, and information sharing

---

### 6.5.

Information systems on port State measures

---



The on-board inspection of foreign vessels in port plays a central supporting role in detecting evidence of IUU fishing or related activities and implementing the requirements of the IOTC PSMR. Levels and priorities for inspection are provided in Part 4 of the Resolution, "*Inspections and Follow-up Actions*", and include the following requirements, shown below.

- As a minimum, each CPC must carry out inspections on at least 5 percent of landings or transshipments in its ports during each reporting year.
- The inspections must involve monitoring the entire discharge or transshipment and include a cross-check between the quantities by species recorded in the prior notice of landing and the quantities by species landed or transhipped. For transshipments, the information should also be cross checked with the information from the IOTC Observer on the carrier vessel. When the landing or transshipment is completed, the inspector shall verify and note the quantities by species of fish remaining on board.
- Inspectors should make all possible efforts to avoid unduly delaying a vessel and ensure that the vessel suffers the minimum interference and inconvenience and that degradation of the quality of the fish is avoided.
- The port CPC may invite inspectors of other CPCs to accompany their own inspectors and observe the inspection of landings or transshipment operations of fishery resources caught by fishing vessels flying the flag of another CPC.

The resolution requires that the inspectors carry out functions described in Annex 11 ("*Port State Inspection Procedures*") as a minimum standard).

In addition, each CPC in carrying out inspections in its ports, must conform with paragraph 11 in the IOTC PSMR ("*Conduct of Inspections*") and:

- ensure that inspections are carried out by properly qualified inspectors authorised for that purpose;
- ensure that, prior to an inspection, inspectors are required to present to the master of the vessel an appropriate document identifying themselves;

## Port State measures

### Procedures for the implementation of the Indian ocean Tuna Commission

- ensure that inspectors examine all relevant areas of the vessel, the fish on board, the nets and any other gear, equipment, and any document or record on board that is relevant to verifying compliance with relevant conservation and management resolutions;
- require the master of the vessel is required to give inspectors all necessary assistance and information, and to present relevant material and documents as may be required, or certified copies thereof;
- if there are appropriate arrangements with the flag State, invite the flag State to participate in the inspection;
- make all possible efforts to avoid unduly delaying the vessel to minimise interference and inconvenience, including unnecessary presence of inspectors on board, and to avoid action that would adversely affect the quality of the fish on board;
- make all possible efforts to facilitate communication with the master or senior crew members of the vessel, including where possible and where needed that the inspector is accompanied by an interpreter;
- ensure that inspections are conducted in a fair, transparent and non-discriminatory manner and do not constitute harassment of any vessel;
- not interfere with the master's ability to communicate with the authorities of the flag State in conformity with international law.

National legislation, procedures or an interagency memorandum of understanding should clearly designate the authority for permitting the vessel to enter and use the port for all purposes provided in the IOTC PSMR and for conducting initial inspections.

It is recommended that the fisheries authority should play the lead role and be aware at all times of the vessel movements.

## 6.1. Pre-boarding process

### 6.1.1. Selection of fishing vessel and risk assessment

Following the assessment of the AREP and depending on the perceived risk based on the outcomes of the RAR or Checklist, a final decision is made (**Box 33 & Box 34**). Where there is:

- sufficient proof of IUU fishing or related activities, then:
  - deny port entry, conditional on a valid request by the vessel for health and safety of the crew or force majeure that may endanger the vessel and crew;
  - allow port entry exclusively for the purpose of inspecting it and taking other appropriate actions but deny all use of port;
- insufficient proof of IUU fishing or related activities, then:
  - allow port entry and inspect at least 5 percent of landings or shipments in ports during each reporting year;
- a finding that the vessel does not have an authorisation for fishing or related activities required by the flag State or a coastal State, or evidence that the fish on board was taken illegally from coastal State waters, or the flag State does not confirm that the fish on board was taken in contravention of an RFMO's CMMs, or there are reasonable grounds to believe that the vessel was otherwise engaged in IUU fishing or related activities;
  - deny use of port, communicate decision to flag and relevant coastal States and IOTC and, as needed, inspect;
- Allow port entry under a valid claim of force majeure or distress where it will not threaten or adversely affect the safety, security, environment, good order of the port State.

### Box 33 | Risk assessment outcomes

*If the vessel is not on an IUU Vessel List or there is insufficient proof of having engaged in IUU fishing or related activities, then depending on the results of the RAR and/or Checklist, it will be categorised as a high, medium or low risk vessel which in turn should influence the inspection process.*

### ***High risk***

A high-risk vessel will require a full inspection involving:

- inspection of all documents and cross referencing document information with that provided in the AREP (vessel registration and safety certificates, authorisation(s) to fish, authorisations for transshipment, transshipment declarations catch logbooks, production logbooks, engineers logbooks);
- inspection of gear and recording gear specifications;
- hold inspection to estimate volume and weight of the catch, and validate the processed catch for correct packaging identification as well as correct weights; and
- identification of the catch species on board.

The results of the inspection will determine whether or not to allow the vessel further port facilities. Should the inspection result in any suspicion that the vessel has been engaged in or associated with IUU fishing it can be denied further port services, vessel can be detained and appropriate flag State, coastal States and IOTC Secretariat are so informed. In the event that the results of the inspection are inconclusive the vessel may be requested to provide further information to verify that it has not been associated with IUU fishing activities.

Port services may be suspended until such information is provided. Where the result of the inspection verifies that the catch and fishing methods conform to the conservation measures of the IOTC then it should be granted permission to continue with off-loading its catch and be granted port facilities. It would be expected that if the vessel is given permission to continue to land its catch, the off-loading will be fully monitored to verify catch statistics provided.

### ***Medium risk***

A vessel will be classified as medium risk where some of the information provided cannot, with a high level of confidence, be verified or is inconsistent with some information collected in the data search. The inspection process will first address these inconsistencies and could, as a result, deny the vessel

all use of port. Should the result of the inspection be acceptable, then the vessel will be granted permission to continue with its planned port activities.

Depending on the results from verifying information of the vessel's documents, the inspection process may be extended to include inspection of the gear and catch prior to allowing the off-loading to commence. It would be expected that if given permission to continue to off-load, the vessel's catch will be fully monitored to verify catch statistics.

### ***Low risk***

Vessels that have regularly entered the port without any prior record of infringements and where all their information has been verified may be limited to a routine inspection of their documents. Depending on the size of the port and the number of vessels entering it is conceivable that not all these vessels will be fully inspected at each port visit. Depending on the regulations of the port State the landing of the catch may also be monitored.

#### **Box 34 | Risk categories assigned to vessel**

*Three risk categories can be assigned to vessels given permission to enter port.*

- High Risk - Unverified data provided but no record of IUU activity. No prior inspection record.
- Medium Risk - Data partially verified but uncertainties still exist.
- Low Risk - Data verified and vessel routinely inspected during prior port visits.

*Assigning these risk levels to vessels will assist in determining and planning the operational requirements of the inspection.*

### **6.1.2. Preparation for boarding**

The importance of preparations prior to boarding a vessel in port cannot be over-emphasised. All subsequent activities during the inspection will depend on the thoroughness of these checks.

#### ***Preparation of documents***

Prior to undertaking the operation the inspection teams should be given a detailed briefing covering all the relevant documents they will required to check and the report forms that will have to be completed during the inspection.

The documents should include those shown below.

- summary of investigation from the risk assessment, noting specifically any information that should be verified in detail;
- the vessel's details and name of the master and fishing master;
- the mandate authorising the inspection, referencing the relevant IOTC resolutions and the country's legislation;
- gear present on board;
- list of the product codes and weight of the target and by-catch species that the vessel declared on board;
- copies of the inspection reports;
- notebook for recording additional information;
- discharge forms;
- name of observer aboard, if available.

#### ***Vessel photographs***

A detailed inventory of digital pictures of vessels is a valuable tool to positively identify vessels and discover where IUU vessels may have changed names and registration numbers.



The physical structure of the vessel, relative position of the bridge, rails, equipment and aerial arrays are key features used to identify a vessel. Detailed pictures of the hull showing physical damage, such as dents or weld marks are unique features that can be used to positively identify a vessel even after modifications and painting. A photographic record should be set up and maintained of all vessels calling into the port and where necessary these can be shared with other port States and IOTC.

### ***Communication and agent responsibility***

The leader of the inspection team must have a means of communication (mobile phone or radio) to be able to communicate with their office. In the inspection process this will allow for queries on documentation or to get advice on any aspect that may not have been covered in the pre-briefing or analysis of the AREP.

Prior communications with the vessel will, in most cases, be through the vessel's agent. The agent can assist with translations and is most likely to have direct links with the vessel operators and / or owners. The arrangements to undertake the inspection and the presence of the agent during the inspection can facilitate communications and the inspection process. Where there is no one to assist with translation then "*translations cards*" will have to be used to request the documentation and communicate on the inspection process of gear and catch. This may slow down the process and inspectors need to maintain a strict protocol of being both firm and patient, especially when dealing with a vessel that is undertaking its first port visit.

### ***Inspection protocol***

#### ***Inspectors' uniforms***

Appearance and uniform dress are important aspects when inspecting a vessel. A uniform represents the authority that is necessary for the importance of the inspection process. Inspectors, through the Fisheries Management authority, also represent their State on the vessel. However, the practicalities of moving around on the vessel also have to be taken into account. It is conceivable that an inspection team of several persons could be dressed differently. The lead of the inspection team, in a formal uniform to undertake the

## Port State measures

### Procedures for the implementation of the Indian ocean Tuna Commission

introductions and document inspection, with assisting members dressed in apparel that will be more suitable for moving around on the vessel to inspect gear. Inspection of refrigerated holds will also require suitable protective clothing.

In all aspects the dress must take into account health and safety standards and the requirement to wear safety boots, hard hats and reflective jackets. Thin working gloves are usefully to both protect the hands from sharp objects and have the added advantage of keeping your hands clean when inspecting and handling gear on board.

#### Introduction protocol

The first introduction to the vessel's personnel and the protocols followed are very important in preparing for the full inspection process. They highlight the importance and significance of the inspection to follow.

When first boarding, if not met by an officer or the agent, remain either on the quay side or next to the boarding ramp and wait for a vessel representative to lead you to the bridge. Introductions and presentation of identification must follow irrespective of whether the vessel has been boarded before or the personnel are known. This can have implications should a judicial process follow from any infractions discovered and reported after the inspection.

Countries' customs vary with respect to shaking hands and initial address. A cue can be taken from the vessel personnel and on some oriental vessels a polite bow may be the most appropriate. Providing the names and identity of the inspection team should follow the greeting by presentation of official identification cards. As soon as possible ascertain the rank of the officers or crew meeting the team and address them by their rank.

Request a suitable place to work on board to analyse documents. Larger carrier vessels have a "day-room" for the master that serves as an office and is ideal. Giving consideration to limited space on fishing vessels a suitable work space could be the chart table, radio room or a convenient space on the bridge.

## Inspection tool kit

Inspectors must be equipped with the documents, identification guides and equipment necessary to record details of gear specification and measure gear. A checklist of the inspector's tool kit for conducting an inspection on board would include the kit in *Figure 82*.

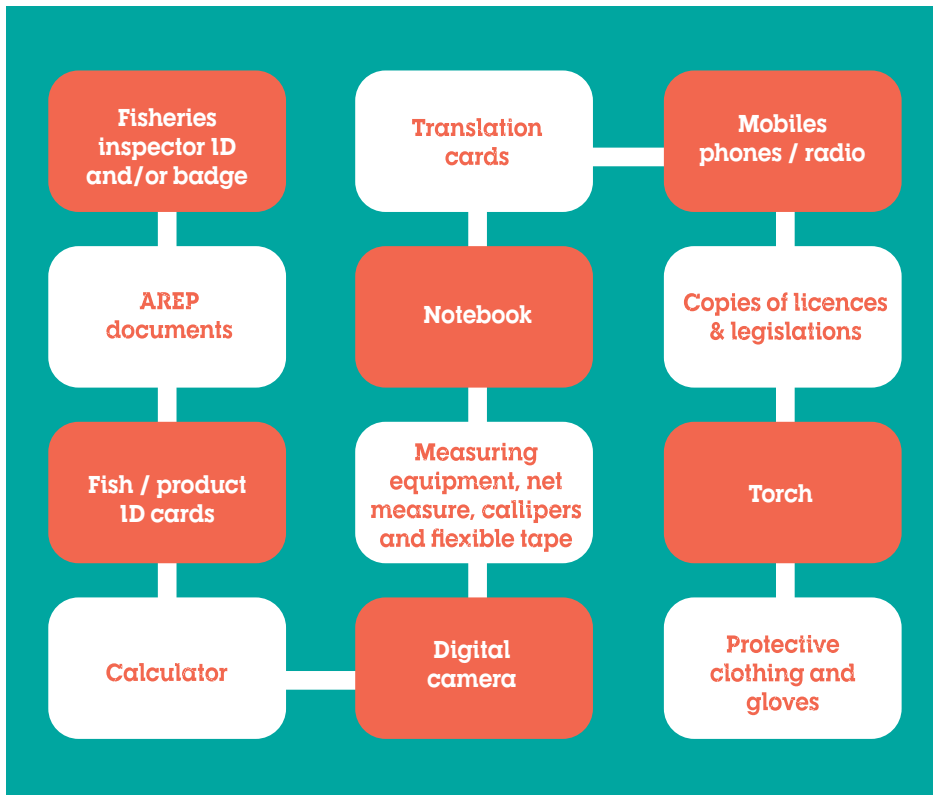

Source: IOTC, 2021

*Figure 82: Inspection tool kit*

### ***Inspector notebook***

It is essential that inspectors carry a personal notebook at all times and record additional and supporting information resulting from their inspections. Data recorded should as far as possible be cross referenced to the numerical sections of the port inspection report form. A detailed notebook, with clear dates and kept in chronological order can be invaluable for compiling more detailed reports on inspections and may also serve as evidence in a judicial process. When taking digital photographs, it is also important to cross reference them to notes taken at the time.

## **6.2. On board inspection - Standard Operating Procedures**

### **6.2.1. Requirement of the port State inspection**

Detailed requirements for port State inspection procedures are in Annex 11 of the IOTC PSMR. The operating procedures for inspection proposed below are provided as a guide and should be developed, utilised and modified by inspection teams to suit the situation at the time of inspection or depending on the condition on board. It is divided into two main sections, inspection of documents and physical inspection, described below.

### ***Inspection of documents***

The inspection of the documents on board the fishing vessel requires the inspector to verify:

- and cross reference information with the assessment of the AREP;
- the information found during the inspection of the documents with findings from the physical inspection;
- operations and catch details (e.g. fishing logbook) with those monitored on board by observers or logbooks, or during the offloading process.

### ***Physical inspection***

Physical inspection is the "hands on" part of the inspection and includes recording gear specifications and checking on equipment to verify information provided in the documentation, and looking for additional components that have not been listed or declared. The process includes:

- inspecting compartments for gear or equipment or evidence of catch;
- inspecting bridge equipment for its working order and reliability, e.g., navigation plots, VMS, AIS, computers, etc.;
- inspecting fish storage holds;
- identifying fish, weights and products to see if they conform to catch and transshipment documents;
- monitoring the off-loading process.

### ***Port Inspection Report Form (Annex III of the IOTC PSMR)***

The port inspection report form is presented in Appendix IX together with a description of the required information and format for each of the data fields that have to be completed by the inspection team following the inspection of the vessel.

A complementary inspection report form (B) related to compliance with IOTC CMMs has been developed (Appendix X) to verify the compliance with technical management measures that apply to fishing vessel fishing for tuna and tuna-like species in the IOTC Area.

The IOTC PSMR requires that:

*"the port State CPC shall, within three full working days of the completion of the inspection, transmit by electronic means a copy of the inspection report and, upon request, an original or a certified copy thereof, to the master of the inspected vessel, to the flag State, to the IOTC Secretariat and, as appropriate, to:*

- a.** *the flag State of any vessel that transhipped catch to the inspected vessel;*

## Port State measures

### Procedures for the implementation of the Indian ocean Tuna Commission

- b. *the relevant CPCs and States, including those States for which there is evidence through inspection that the vessel has engaged in IUU fishing, or fishing related activities in support of such fishing, within waters under their national jurisdiction; and*
- c. *the State of which the vessel's master is a national. (IOTC PSMR paragraph 13.1).*

The IOTC Secretariat is also required to "without delay" transmit the inspection reports to the relevant regional fisheries management organisations, and post the inspection report on the IOTC website.

#### **6.2.2. Port State inspection - Standard Operating Procedures**

The procedures for carrying out a port inspection of a vessel should support the implementation of national legislation. National legislation, in turn, should implement IOTC CMMs, but this is not always the case.

Inspectors should be aware of the requirements in both national legislation and those in relevant IOTC CMMs, and keep in mind that it is only the national legislation that can serve as a basis for further legal or administrative proceedings by the port State.

Port States should ensure that national legislation provides a strong legal basis clearly describing contraventions of the relevant IOTC CMMs. This will ensure that inspectors' actions are enforceable and can secure compliance by the vessel.

However, even where CMMs are not implemented in national legislation, their procedural requirements are still applicable to IOTC CPCs:

- **port States**, which must apply the CMM procedural and reporting requirements;
- **flag States**, which have a duty to require its vessels to cooperate with the port State in inspections.

The procedures for carrying out port inspections comprise several key elements that never change, but the responses of the master or the facts as they are uncovered on board can lead to a host of unplanned situations.

The language cards carry all of the main constituents of an inspection and may be used for reference, but the inspector on board the fishing vessel will have to exercise sound professional judgement in many cases where situations are not catered for.

The following sections provide a description of the operational steps to be followed, and the actions involved, in undertaking a vessel inspection, while using the inspection form in Appendix IX. For every step, a link is made to the field of the IOTC inspection report required to be completed (for example, see the blue box on the right side of the page, where it refers to numbers such as 1 to 6).

For every step, some of which are summarised below, the actions must be completed in a formal process and undertaken even if the inspector is familiar with the vessel.

Support vessels include those vessels that set and recover FADs in the purse seine fishery. They will not have catch or fishing gear on board, so inspections will concern licence details, vessel documentation, compliance with IOTC CMMs on FAD management and the status of the vessel on RFMO positive and IUU Vessel Lists.

### ***General instruction on the procedure during port inspection***

The boxes in this section provide examples of contraventions of IOTC Resolutions which inspectors must report. This is important for reporting to IOTC. However, for any charges to be laid or legal process to be instituted at national level, the IOTC Resolutions must first be implemented in the country's fisheries legislation. The inspectors should check to make sure this is the case, including by asking the responsible legal authorities for advice. Steps and details of port inspections are presented in [Table 29](#).

## Port State measures

### Procedures for the implementation of the Indian ocean Tuna Commission

Table 29 - Steps during an inspection, and their details

END	<b>A</b> Prior to boarding	Take photographs of the marks of the vessels (stern, broadside and bow), aerial array above the bridge and any flags hoisted.
	<b>B</b> Embarkation on the fishing vessel	Introduce yourself to the master, present professional ID and legal mandate, request cooperation, request AREP and authorisation of entry, provide a short brief on the inspection process.
PORT INSPECTION PROCEDURES	<b>C</b> Place to work	Request master to provide a place to work to analyse documents.
	<b>D</b> Vessel details and flag State registration	Verify authenticity/validity of vessel's documents against the specimens / AREP. Cross reference vessel's marks / characteristics with information in the vessel's documents and IOTC RAV.
	<b>E</b> Name, address of owners, beneficial owner, operators	Cross reference to the details provided in the AREP. Verify discrepancies against the IOTC lists of authorised vessels and if available from the IMO number.
	<b>F</b> Name, address of master, fishing master and agent	Request ID of the master, the fishing master and the agent. Cross reference with the information that was provided in the AREP.
	<b>G</b> VMS unit, power and transponder inspection	Check if VMS installed on-board for vessel 24 metres in LOA or above, or those less than 24 metres operating outside the flag State EEZ fishing for IOTC species within the IOTC area, and check for VMS located in sealed unit, tamper proof seals or mechanisms, power supply connections and back-up power, LED lights ON, input cables, antenna.
	<b>H</b> Status in RFMO	Verify status on RFMOs positive list and on the IUU Vessel List.
	<b>I</b> Authorisation to fish (ATF)	Check ATF from flag State and fishing license from Coastal State: authenticity, validity, area of operation, gear, and against specimens. Verify if there is any modification made on ATF.
	<b>J</b> Transshipment authorisations	Verify authenticity, validity and area of operation of the authorisation to tranship.



START	<b>K</b> Transhipment information concerning donors vessels	Review documentation of all transhipments. Verify the status of the donor's vessels on the IOTC RAV and the IUU Vessel List.
	<b>L</b> Evaluation of offloaded catch	Record reported weights to be off-loaded prior to the commencement of the off-loading operation. Cross reference to the estimated weights determined from the estimates made while monitoring the off-loading.
	<b>M</b> Catch retained on board - hold inspection	Request the master to produce the quantity by species retained on board the vessel. Estimate the catch in the holds.
	<b>N</b> Examination of logbooks	Master to produce the fishing, processing, freezer, engineering logs. Cross reference areas of operation detailed in fishing logs to information in AREP and to the authorised areas for fishing.
	<b>O</b> Catch Document Schemes and trade information	Cross check declared weight of species on board with applicable catch document schemes. Weights specified on the catch documents must correlate with the off-loaded weights.
	<b>P</b> Fishing gear	Review the information on vessel type and authorised fishing gear provided in AREP and conduct a detailed inspection of the fishing gear on board. Verify that the gear and gear specification conform to the authorisations and licenses issued to the vessel. Search illegal fishing gear.
	<b>Q</b> Protected and endangered species	Inspect line cutters, de-hookers and dip-nets used to release marine turtles. Check if the vessel has on board a "tori" bird scaring line. Check for shark fins and determine percent of fins. Check for thresher sharks, trunks or fins on board.
	<b>R</b> Report completion	Inspection team to reconcile the findings of the inspection. Copy of inspection report provided to the master.
	<b>S</b> Signing the inspection report	Fisheries inspector and master sign the inspection report. Ask the master if there are any complaints.

**A** *Prior to boarding***1 to 6 / 8 to 9****Action to be taken**

It may be appropriate to ensure that the other agencies involved in port operations are all pre-informed of the fisheries mandate and actions being taken as well as the accompanying and the vessel's agent in case there are queries from the vessel during these pre-boarding activities.

- |          |   |
|----------|---|
| <b>1</b> | Take photographs of the stern, broadside and bow; and of the hull on both sides. The out board side can often be photographed from a jetty on the opposite side and then zooming in on the hull.  |
| <b>2</b> | Take detailed [zoom in] photographs of the aerial array above the bridge and of any flag(s) hoisted   |
| <b>3</b> | Record the name and numbers painted on the bow and stern and any alphanumeric numbering displayed next to the bridge that may include the international radio call sign, fishing licence number, national registration number, port of registry, IMO number |

The inspection report form B on Compliance with IOTC Conservation and Management Measures (Appendix X) provides the necessary fields to record the information related to marking of fishing vessel (Figure 83). It allows the inspector to record the marks displayed on the stern, port side and starboard side, for the name, the national registration number and the IRCS of the vessel.



© IOTC

*Figure 83: Confused marks on the stern of a longliner that need further investigation during the inspection*

Then it allows the inspector to cross reference the marks displayed with the information of IOTC Record of Authorised Vessels and the documentation verified on board.

It may be appropriate to ensure that the other agencies involved in port operations are all pre-informed of

the fisheries mandate and actions being taken as well as the accompanying and the vessel's agent in case there are queries from the vessel during these pre-boarding activities.

## **B** *Embarkation on the fishing vessel to be inspected* *(Box 35)*

**1 to 6 / 8 to 9**

### **Action to be taken**

<b>1</b>	Check evidence of hostility on board before embarking on the vessel.
<b>2</b>	If the master is not present you must ask to be taken to the master
<b>3</b>	You must introduce yourself by your name, institution/administration and title " <i>Fishery Inspector of (country) ....</i> ".
<b>4</b>	You must provide to the master your professional identity card and reference the legal mandate for undertaking the port inspection
<b>5</b>	You must ask for cooperation with the inspection team
<b>6</b>	Request the master to confirm the purpose of the port call and access to the port
<b>7</b>	If not provided previously, request the master to present the authorisation for entry
<b>8</b>	Provide a short brief on the inspection process that will be undertaken and possible consequences if irregularities are found (Deny use of ports, port State enforcement actions, request listing on the IOTC IUU vessel list)
<b>9</b>	Record in the form the date and time of your arrival on board

## Port State measures

Procedures for the implementation of the Indian ocean Tuna Commission

### Box 35 | Examples of contraventions of the IOTC PSMR violations following embarkation of inspectors on the vessel

#### *IOTC PSMR Paragraph 7.2*

The master or agent had not presented the authorisation to enter port upon the vessel's arrival into port.

#### Paragraph 17.1 of IOTC PSMR

*requires CPCs to require its flag vessels to cooperate with the port State in inspections. National legislation usually requires cooperation and do not permit obstruction, etc.*

If the master does not cooperate with the inspection team, you must warn the captain that failure to cooperate with this legal process might result in taking further action against him. You explain that this behaviour constitutes a violation of the national fisheries legislation and the IOTC PSMR

Then ask again if the master is willing to cooperate. If the reply is still negative the inspection procedure stops. You must inform your fisheries authority and await further instruction.

Where a vessel carries an observer on board, it is in the inspector's interest to request the observer report (if available) and discuss relevant vessel operations (at a suitable place and time) with the observer in order to glean as much detail about the vessel and its operations as possible.

## **C** *Place to work*

### Action to be taken

1

Request the master to provide a suitable place to work to analyse documents. This can be the chart table, radio room or a convenient space on the bridge

## D *Vessel details and flag State registration (Box 36)*

**11 to 18**

### Action to be taken

<b>1</b>	Request the vessel's registration documents, navigation, tonnage and safety certificates and any other available documents that will assist with verifying information in the AREP
<b>2</b>	Verify the authenticity and validity of the documents with the specimens (if available)
<b>3</b>	Cross reference the available information with the findings of the assessment of AREP
<b>4</b>	Cross reference the external marks of the vessel against the details of the vessel including vessel name, national registration number, international radio call sign and, if available, the IMO number
<b>5</b>	Cross reference the characteristics of the vessel in the documents against the details of the vessel in the IOTC record of vessels, including length (LOA), gross tonnage (GT), national registration number, and international radio call sign
<b>6</b>	Question any discrepancy and record the answers and any evidence that may arise from the verification process
<b>7</b>	Make copy or take photographs of the documents that contain information different from the external marks or different from the IOTC record of authorised vessels

The external marks of the fishing vessel recorded in step A must be verified against the vessel details in the documents on board and as well against the details recorded in the IOTC list of authorised vessels.

Verification must be made against national legislation as well if more specific with regards to mandatory marks to be displayed on the fishing vessel and documents to be present on board.

Any altered, falsified, deleted or concealed marks on the vessel must be corrected and conditional to the departure of the port for the next fishing trip.

You can request previous inspection reports that will provide you guidance to the inspection process.

– Standard Operating Procedures - on board inspection of vessel –

## Port State measures

### Procedures for the implementation of the Indian ocean Tuna Commission

#### Box 36 | Examples of contraventions of IOTC Resolution 19/04 PSMR violations on vessel details and flag State registration

- A document of the vessel is not present on board - paragraph 2.a of IOTC Resolution 19/04,
- A document of the vessel is not issued by the competent authority of the flag State - Article 2.a. of IOTC Resolution 19/04
- The external marks of the fishing vessel (name, national registration number, IRCS) are not consistent with the information of the vessel's documents - paragraph 3. of IOTC Resolution 19/04
- The external marks of the fishing vessel are altered, falsified, deleted or concealed in such a way that the vessel cannot be really identified - paragraph 3 of IOTC Resolution 19/04.

## E

### *Name, address, contact of owners, beneficial owner(s) and operators*

19, 20 and 21

#### Action to be taken

1	Record the details of the owners, beneficial owner(s) and operators of the vessel (e.g. from the registration and safety documents of the vessel)
2	Cross reference this information to the details provided in the AREP
3	Verify discrepancies from details recorded in the IOTC lists of authorised vessels and if available from the IMO number

The name of the owner(s) can be cross referenced with the owner(s) details from RFMOs IUU Vessel List, including past IUU Vessel List. The owner having a vessel already placed on a RFMOs IUU Vessel List would automatically place the inspected vessel on the high risk level. Cross reference of owner details against RFMOs IUU Vessel List could have been concluded in the analysis of the AREP.

## F *Name, address and contact of vessel master, fishing master and agent*

**22, 23 and 24**

### Action to be taken

<b>1</b>	Request the identification document of the master, the fishing master and the agent. This should be their original passport or international marine identification documents. [Note: Copies are not acceptable], make copy or take picture of the passports or national identity cards
<b>2</b>	Request a copy of the crew list
<b>3</b>	Cross reference the details of the master and the information that was provided in the AREP

## G *Vessel monitoring system (Box 37)*

**25**

### Action to be taken

VMS fitted on board and functionality	
<b>1</b>	Check if the VMS is obligatory (24 metres in LOA or above, or those less than 24 metres operating outside the flag State EEZ fishing for IOTC species within the IOTC area – IOTC Resolution 15/03) 15/03, or if authorised to fish in the waters of a coastal State, check fishing licence or fishing agreement for VMS conditions)
<b>2</b>	Request for the master to accompany to verify the on board VMS installation (junction boxes, antenna and cables)
<b>3</b>	Verify that the system is fitted on board and check to see if there is one or more VMS unit. Note the make, model and serial number
<b>4</b>	Check the VMS unit(s) noting physically: the installation, device is located in a sealed unit and protected by official seals (tamper proof seals), power supply connections and back-up power, LED lights to indicate power supply ( <i>Figure 91</i> ), any input cables for integrated positioning
<b>5</b>	Check the antenna above the bridge, and any paint residue on the antenna
<b>6</b>	Check cable connection and if possible that it conforms to the aerial cable into the unit

## Port State measures

### Procedures for the implementation of the Indian ocean Tuna Commission

#### VMS failure event

- 1 Request the captain to provide the last failure events on board. If VMS failure has occurred, verify that the vessel has communicated to the FMC of the flag State the vessel identification, the date & positions every 4 hours. Record the type of communication (email, fax, telex, telephone)
- 2 Verify that the technical failure has been communicated to the flag State and/or the IOTC Secretariat
- 3 Verify if the device was repaired or replaced within one month, record the date of repair

#### VMS alteration

- 1 Check signs of alteration of device on board: connection of external GPS to the VMS unit, damaged cable, obstruction of GPS signal, power supply not interrupted
- 2 Take photography



Figure 84: Argos junction Box switched off

The inspection report form B on compliance with IOTC Conservation and Management Measures provides the necessary fields to record the information related to the VMS. It allows the inspector to record the outcomes of the VMS inspection on the functionality of the device, technical failure and alteration (e.g. antenna, power supply).

© IOTC

Verification must be made against national legislation as well if more specific with regards to the requirements of VMS.

In the event that a CPC has information to suspect that on board vessel monitoring device(s) have been tampered with, it shall immediately notify the IOTC Secretary and the vessel's flag State (Annex 1 paragraph A- IOTC Resolution 15/03).



### Box 37 | Examples of contraventions of IOTC Resolution 15/03 violations on the vessel monitoring system

- The vessel is above 15 m LOA and no VMS is installed on board (paragraph 1 IOTC resolution 15/03)
- The vessel monitoring device has been tampered with, and /or is not located in a sealed unit and/or is not protected by official seals (paragraph 6 IOTC Resolution 15/03)
- The antennae connected to the satellite monitoring device(s) is obstructed and/or the power supply of the satellite monitoring device(s) is interrupted (paragraph 7 IOTC Resolution 15/03).

## G *Status in RFMO (Box 38)*

26

### Action to be taken

<b>1</b>	Determine and cross check from the authorisations on board the status of the vessel in the IOTC (or any other RFMO). This information should also correspond to documents issued by the flag State
<b>2</b>	Ask the master if during the current fishing trip the vessel has been engaged in fishing or related activities in the area of another RFMO (e.g., CCAMLR, CCSBT, ICCAT, WCPFC) and if there are fish on-board taken in this area. Note the RFMO Area and cross check with fishing positions from the fishing logbook and the navigation logbook
<b>3</b>	If fishing positions are found in the area of competence of another RFMO, verify the status of the vessel on the list of authorised vessels of the concerned RFMO, Question the master on the reason to why the vessel is not registered with the concerned RFMO and record the answers. Request the master to produce the quantity of fish harvested in the RFMO area and present on board

Information on the status of the vessel should have been concluded in the analysis of the AREP with respect to its status on the positive list or in the IUU Vessel List.

## Port State measures

### Procedures for the implementation of the Indian ocean Tuna Commission

If there is evidence of fishing activity within the area of another RFMO or areas under the national jurisdiction of a coastal State and the vessel is not registered with the RFMO or does not have permission required by the coastal State to fish in its waters, report the result of the investigation to the concerned RFMO, to the flag State of the vessel, to the coastal State and to the IOTC Secretariat.

#### Box 38 | Examples of contraventions of the IOTC requirements for registration on the RAVPSMR violations

*The vessel harvests engages in fishing or related activities for tuna or tuna-like species in the IOTC area of competence and is not registered on the IOTC Record of Authorised Vessels (Resolution 13/02).*

## 1

### Authorisation to fish (Box 39)

27

#### Action to be taken

Review the authorisations to fish on board the vessel, noting specifically their period of validity, area of operation and permitted target and by-catch species. The inspection should include the following actions.

1	Request the master to produce the authorisation to fish (ATF) issued by the vessel's flag State that includes authorisation to fish within RFMOs areas on the high seas
2	Request the master to present the fishing licences issued by the coastal States that have provided the vessel with permission to fish within their EEZ
3	Verify authenticity, validity and area of operation in the ATF and the fishing license. If available, verify authenticity and validity of the documents with the specimens
4	Verify if there is any modification made on the ATF. Modification on the ATF must be certified by the competent authority of the flag State
5	If the vessel has been fishing in the EEZ of the Port State, verify if the conditions of the fishing license are respected: species, fishing gear, catch reports, VMS reports, by-catch / discard restrictions

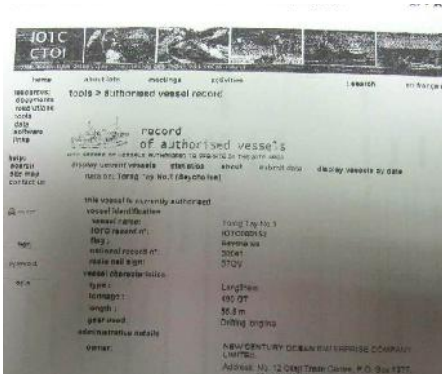

**Figure 85:** ATF produced by the master. It is a web print of the IOTC record of authorised vessel of the inspected vessel

ATF issued by flag State should have "IOTC area" as the area of operation. Fishing licenses issued by a coastal State should apply to areas wholly or partly under its maritime jurisdictions (e.g. EEZ).

For any irregularities detected on the ATF, communicate with the flag State using the form "Request for additional information following a port inspection".

### Box 39 | Examples of contraventions of the IOTC Resolution - Authorisation to fish

- The vessel does not have a valid and applicable authorisation to engage in fishing or fishing related activities required by its flag State (paragraph 2 - Resolution 19/04);
- The vessel does not have a valid and applicable authorisation to engage in fishing or fishing related activities required by a coastal State in respect of areas under the national jurisdiction of that State.

If the master is unable to produce a valid ATF or fishing licence (**Figure 85**), his reason for doing so is to be recorded in the notebook.

ATF issued by flag State must be on board the fishing vessel at the time of the inspection (Resolution 19/04).

If you find any modification on the ATF not certified by the competent authority of the flag State, request the master to explain and record the response in the notebook.

**J** **Transshipment authorisations (Box 40)****Action to be taken**

Review documentation of all transshipments, noting specifically authorisations issued by relevant CPCs and fishing authorities to donor or receiving vessels and cross check quantities reportedly transhipped to declarations submitted by the vessels to their fishing authorities and the IOTC and where possible with IOTC observer data (if available).

<b>1</b>	Ask the master if the LSTLV (Large-scale tuna longline vessel) has been engaged in transshipment operation(s) at sea (high seas or EEZ of a coastal State) and name of vessel(s) involved. Request position, date, time and quantity of fish. If applicable request the master to produce the IOTC transshipment declaration
<b>2</b>	Request the master to produce the authorisation to tranship issued by the vessel's flag State that includes authorisation to tranship within RFMOs areas on the high seas and/or issued by the coastal States that have provided the vessel with permission to tranship within their EEZ
<b>3</b>	Verify authenticity, validity and area of operation in the authorisation to tranship
<b>4</b>	Request the communication logbook to cross reference with the location of transshipment operation(s) and details of receiving vessel and check if there is any communication record with others vessels. Request the master to explain the reasons of the communication (e.g. supplying, fuelling) and verify the status of the vessels on the IOTC positive list and IUU Vessel List of RFMOs

**Box 40 | Example of contravention of IOTC Resolutions on transshipment authorisation**

- The vessel has engaged in transshipment without authorisation tranship issued by the flag State or the coastal State.
- The vessel has transhipped with, or participated in joint operations such as re-supplying or re-fuelling, with vessels included in the IUU Vessel List.

Three fundamental rules apply to LSTLVs for transhipment at sea (Resolution 19/06, paragraphs 12, 13 and 14 ):

- LSTLVs are not authorised to tranship at sea, unless they have obtained prior authorisation from their flag State(flag States must only authorise carrier vessels on the IOTC Record of Authorised Carrier Vessels; carrier vessels not entered on the record are deemed not to be authorised to receive tuna and tuna-like species and sharks in at-sea transhipment operations);To receive the prior authorisation to tranship, the master and/or owner of the LSTLV must notify the following information to its flag State authorities at least 24 hours in advance of an intended transhipment:
  - a. the name of the LSTLV, its number in the IOTC Record of Vessels, and its IMO number, if issued;
  - b. the name of the carrier vessel, its number in the IOTC Record of Carrier Vessels authorised to receive transhipments in the IOTC area of competence, and its IMO number, and the product to be transhipped;
  - c. the tonnage by product to be transhipped;
  - d. the date and location of transhipment;
  - e. the geographic location of the catches (paragraph 13).
- The LSTLV concerned must complete and transmit to its flag State, not later than 15 days after the transhipment, the IOTC transhipment declaration, along with its number in the IOTC Record of Fishing Vessels in accordance with the format set out in Annex III of the Resolution (paragraph 14).

Transhipments by LSTLVs in waters under the jurisdiction of the CPCs are subject to prior authorisation from the coastal State concerned (Resolution 19/06, paragraph 12).

**J** *Transshipment information concerning donor vessels (Box 41)***Action to be taken**

This step applies to the receiving vessel. Review the documentation of all transshipments, noting specifically authorisations issued by relevant CPCs and fishing authorities to donor or receiving vessels and cross check quantities reportedly transhipped to declarations submitted by the vessels to their fishing authorities and the IOTC.

<b>1</b>	Ask the master if the vessel has been engaged in transshipment operation(s) at sea (high seas or EEZ of a coastal State) and name of vessel(s) involved
<b>2</b>	Request position, date, time and quantity of fish and if applicable request the master to produce the IOTC transshipment declarations
<b>3</b>	Request the master to see the IOTC observer on board the carrier vessel and request the IOTC observer to provide the list of fishing vessels that have transhipped to the carrier vessel, including position, date, time and quantity of fish transhipped and any irregularities recorded by the observer
<b>4</b>	Cross reference the information provided by the master of the carrier vessel and the IOTC observer. If there are discrepancies, question the master and record the response in the inspection report and/or the notebook
<b>5</b>	Verify the status of the receiving vessel and the donors vessels on the IOTC positive list and the IUU Vessel List, or others RFMOs if necessary, (contact the IOTC secretariat to ascertain the status of the vessels at <a href="mailto:transshipment@iotc.org">transshipment@iotc.org</a> )
<b>6</b>	Verify the transshipment declaration involving the carrier vessel and the donor vessels including if the template comply with the IOTC form of resolution 19/06 and if all transshipment declarations have been submitted to the IOTC secretariat (contact the IOTC Secretariat at <a href="mailto:IOTC-transshipment@fao.org">IOTC-transshipment@fao.org</a> )
<b>7</b>	Check if the observer has signed the transshipment declarations

For receiving carrier vessel, the master of the receiving carrier vessel shall complete and transmit the IOTC transshipment declaration to the IOTC Secretariat and the flag CPC of the LSTLV, along with its number in the IOTC Record of Carrier Vessels authorised to receive transshipment in the IOTC area of competence, within **24 hours** of the completion of the transshipment.

If a donor vessel has been fishing in the waters of a coastal State (Catch area), contact the coastal State to confirm that the donor vessel was duly authorised to fish.

#### Box 41 | Example of contravention of the IOTC Resolution concerning donors vessels

*The receiving vessel and/or the LSTLV have engaged in transshipment operations and is/are not registered on the IOTC record of authorised vessels/carrier vessels. (Resolution 19/06)*

## 1

### Evaluation of offloaded catch

30

#### Action to be taken

When vessels are given permission to off-load their catch, standard monitoring procedures must be followed for offloading to a shore side facility or transshipments to another vessel. Quantities and species can be accurately determined using "hook scales" attached to the crane hook and by sub-sampling a representative portion of the fish being off-loaded. Record reported weights to be off-loaded prior to the commencement of the off-loading operation and compare these to the declared weight of product received either by the carrier vessels or cold store ashore.

Cross reference these to the estimated weights determined from the visual estimates made while monitoring the off-loading process. Any significant discrepancies with respect to total weights or species composition must be immediately noted and queried. Detailed records of responses to these queries must be kept in the notebook.

*Size limit: CPCs shall not retain on board, trans-ship, land, any specimen smaller than 60 cm Lower Jaw Fork Length (LJFL) of any of the species striped marlin (*Tetrapturus audax*), black marlin (*Makaira indica*), blue marlin (*Makaira nigricans*) and Indo-Pacific sailfish (*Istiophorus platypterus*) (IOTC Resolution 18/05).*

Refer to section 6.3 on monitoring of offloading which detail the procedure to monitor landing and transhipment in port.

## **M** Catch retained on board - hold inspection

**31**

### Action to be taken

<b>1</b>	Once the landing or transhipment process are finished, request the captain to produce the quantity by species retained on board the vessel
<b>2</b>	Prior to undertaking hold inspections, review the vessel's layout from its registration documents and these should also be displayed as a safety requirement
<b>3</b>	Note number and relative arrangement of holds and blast freezer and volume of each
<b>4</b>	From the cargo or stowage plan in the document review and ascertain the species and product form and stowage position for catches from different fishing areas
<b>5</b>	Request permission of the master to inspect the catch to verify the quantities declared by the master by conducting inspection of the holds of the vessel. Use the drawings/descriptions of layout of the fishing vessel, identify fish holds and quantity. The master is to be invited to accompany the fisheries inspectors
<b>6</b>	Check for unrecorded 'empty' spaces that may be hidden fish holds. Identify refrigeration system and follow the system
<b>7</b>	Note identifiable products and species visibly stowed
<b>8</b>	A photographic record of the inspection process must be compiled

Inspection of the catch retained on board is to be carried out by two fisheries inspectors. When inspecting holds, there must be strict adherence to all safety precautions and dress requirements. When entering the hold, use the information from the hold dimensions as reference and when evaluating the reported product in the hold, a rough comparison of expected volumes can be made. Should there be a notable difference in the assessed volume of product in a hold to that reported, it must be noted for further investigation should the vessel be granted permission to off-load. Blast freezers should be inspected following the same approach as for hold inspections.



On board larger carrier vessels, the fish from different vessels are often stowed in specific locations and separated by nets. Where accessible the product and species may be ascertained from a visual inspection and sample weights of cartons or processed and packaged fish products may be taken to ensure that package weights are not under-reported or wrongly identified.

On board purse seiners the volume of fish held in refrigerated brine can be estimated from visual estimates and known volumes of each well.

Inspector must appreciate that a hold inspection (*Figure 93*) cannot always yield detailed and accurate information, but gross discrepancies may be evident that can facilitate focusing monitoring effort during the off-loading process.



© IOTC



© Mozambique

*Figure 86: Inspection of the fish holds of a tuna longliner*

**N Examination of logbooks (Box 42, Figure 87 & Figure 88)****32****Action to be taken**

<b>1</b>	Request the master to produce the logbooks including fishing, navigation, communication, processing, freezer and engineering logbooks
<b>2</b>	Take photography

Two members of the inspection team should accompany crewmembers to retrieve the logbooks when possible. This is to have corroborated evidence in case logbooks are thrown overboard or otherwise damaged or destroyed before inspection.

The engineering and the freezer logbooks can provide historical engine usage as well as refrigeration/processing logs, useful if IUU fishing is suspected. You can cross reference freezing events against catch events to verify the consistency between the two processes. The freezer logbook should contain pressure, temperature and electric consumption records. For every freezing event, find catch event in the logbook and record the information. For suspicious freezing events, request the master to explain.

**Format and information to be recorded**

Verify IOTC fishing logbook measures for all vessels (Resolution 19/04 and 15/01)	
<b>1</b>	Verify if the fishing logbook is on board at the time of the inspection
<b>2</b>	Verify if an original recording of the fishing logbook is on board for the last 12 months
<b>3</b>	Verify that the fishing logbook has been completed by set and is in date
<b>4</b>	Verify if the fishing logbook includes information on the vessel, the fishing trip, the gear configuration, the vessel operation and catch
<b>5</b>	Verify if the fishing logbook is bound with consecutively numbered pages
<b>6</b>	Verify that the catch is recorded in number & weight / species / set & form of processing
<b>7</b>	Verify that the discard of tuna, tuna-like fish, sharks is recorded in the remarks

Verify IOTC fishing logbook measures for longliners (Resolution 15/01)

- 1 Verify that the fishing logbook contains the primary species: SBF, ALB, BET, YFT, SKJ, SWO, BUM, BLM, SFA, MLS
- 2 Take photographs

Verify IOTC fishing logbook measures for purse seiner (Resolution 15/01)

- 1 Verify that the fishing logbook contains the primary species: ALB, BET, YFT, SKJ
- 2 Verify that the type of association is recorded: Free school or under FAD
- 3 Verify that the deployment of FAD is recorded
- 4 Take photographs

Verify IOTC fishing logbook measures for gillnet vessel (Resolution 15/01)

- 1 Verify that the fishing logbook contains the primary species: SBF, ALB, BET, YFT, SKJ, LOT, FRI, KAW, COM, GUT, BLT, SWO, SFA, BIL
- 2 Take photographs

Verify IOTC fishing logbook measures for pole & line vessel (Resolution 15/01)

- 1 Verify that the fishing logbook contains the primary species: ALB, BET, YFT, SKJ, FRZ, KAW, COM, LOT
- 2 Take photographs

## Port State measures

### Procedures for the implementation of the Indian ocean Tuna Commission

The inspection report form B on Compliance with IOTC Conservation and Management Measures provides the necessary fields to record the information related to the logbook. It allows the inspector to record the outcomes of the inspection of the fishing logbook.

### Catch area and effort

1	Review the fishing and navigation logbooks and cross reference the actual areas of operation detailed in the fishing logbook to information provided in AREP and to the authorised areas for fishing:
2	Fishing logbook entry with position in coastal State maritime zones must be supported by a fishing license issued by the coastal State (see step H)
3	Fishing logbook entry with position in the high seas must be supported by an authorisation to fish issued by the flag State (see step H)
4	Fishing logbook entry with position in the area of another RFMO, see step G
5	Where possible, review and verify information from electronic records that can include: on board GPS plotter integrated with computer back-up (i.e. Maxsea), VMS records from flag State and or RFMOs, AIS, NAVTEX

### Quantity of catch

1	Request the master to produce the fishing masters catch records of the species and the quantity captured during the fishing trip (live weight). Verify that the species and quantities declared correspond to what is recorded in the official fishing logbook
2	Compare those quantities with 1) the estimated quantity found in the holds of the vessel or 2) with the quantity offloaded (Step K) and the catch retained on board (Step L)
3	Any difference between the record of the fishing logbook and the catch, question the master on the reason of such difference

The reason for catch difference between the fishing logbook and the catch found on board could be related to under-reporting of catches in the maritime zones of a coastal State due to commercial quota limit under a fishing agreement or illegal transshipment at sea of the catches.

All records are to be scrutinised to elicit inconsistencies. The master should be asked open questions as to any inconsistencies in the records and his answers recorded in the inspection report or the notebook. Documents should be photographed or photocopied to serve as evidence.



© IOTC

*Figure 87: Fishing logbook at the IOTC format*



© IOTC

*Figure 88: Fishing logbook in a calendar format not matching IOTC requirements*

#### Box 42 | Example of possible contraventions of IOTC Resolutions on fishing logbook

*The vessel does not record or report its catches made in the IOTC area in accordance with IOTC reporting requirements, or make false reports.*

## Port State measures

Procedures for the implementation of the Indian ocean Tuna Commission

### O Catch Document Schemes and trade information

33 and 34

#### Action to be taken

1	Cross check the declared weight of specific species on board with applicable catch document schemes: IOTC Bigeye Tuna Statistical or IOTC Bigeye Tuna Re-export Certificate
2	Verify that the weights specified on the catch documents must correlate with the catch present on board and/or the off-loaded weights
3	Verify that the IOTC Bigeye Tuna Statistical Document is validated by a government official or other authorised individual or institution of the flag State of the vessel that harvested the tuna (Check IOTC database of institutions and persons authorised to validate IOTC statistical documents <a href="https://iotc.org/statdoc?user">https://iotc.org/statdoc?user</a> )

Bigeye tuna caught by purse seiners and pole and line (bait) vessels and destined principally for the canneries in the IOTC Area are not subject to this statistical document requirement. Note that statistical document programme exist for ICCAT on big eye tuna and swordfish and that Catch Documentation Scheme exist for CCSBT for southern blue fin tuna.

### P Fishing gear (Box 43)

35 and 36

#### Action to be taken

1	Verify that the fishing gear and gear specifications conform to the authorisations issued to the vessel (from flag State and/or coastal State if applicable)
2	List all fishing gears inspected and take detailed note of quantities and gears, specifications, type and materials [e.g. mesh, hook type, etc]
3	Inspect fishing gear stowed in compartments and stores, noting:
4	whether spare new gear corresponds to authorised gear
5	possible recently used illegal gear with evidence of recent use. [Note the smell and any fungal growth that occurs when gear is stowed away wet]

#### Verify IOTC measures on marking of fishing gear for longliners (Resolution 19/04)

- 1 While inspecting the gear on board longliner, verify if the fishing gear is marked at day with flag and radar reflector, the fishing gear is marked at night with light buoys, and the buoys are marked with letter/number of vessel identification
- 2 Take photography

#### Verify IOTC measures on marking of FADs for purse seiner (Resolution 19/04)

- 1 If the vessel carries FADs, request the master to inspect them and verify if they are marked with letter/number of vessel identification
- 2 Take photography

#### Verify IOTC measures on driftnet – all vessels (Resolution 17/07)

- 1 If you find large-scale driftnets on board the vessel, ask the master if he has been using the nets on the high seas. Record his answer in the inspection report or the note book
- 2 Verify that the weights specified on the catch documents must correlate with the catch present on board and/or the off-loaded weights
- 3 Verify if the gear is stowed in a manner that he cannot be readily used for fishing
- 4 In the fishing logbook, verify if there are fishing positions and catches in the high seas

The inspection report form B on Compliance with IOTC Conservation and Management Measures provides the necessary fields to record the information related to the fishing gear. It allows the inspector to record the outcomes of the inspection of the fishing gear. In preparation for undertaking the inspection a detailed list of the expected gear should be prepared based on the information provided in the AREP.

## Port State measures

Procedures for the implementation of the Indian ocean Tuna Commission

### Box 43 | Examples of possible contravention of IOTC Resolution on fishing gear

- The buoys are not marked with letter/number of vessel identification (LL, GN)
- Fish aggregating device is not marked with the letter/number of vessel identification (PS)
- The vessel uses prohibited fishing gear (e.g. large scale driftnet on the high seas)



## Protected and endangered species (Box 44)

### Inspection report B

#### Action to be taken

#### Marine turtle

##### Verify IOTC measures for marine Turtles (Resolution 12/04)

- 1 Check to see if there are any instances of marine turtle catch recorded in the fishing logbook
- 2 Request the master to produce the line cutters, de-hookers and dip-nets used to release marine turtles (*Figure 89, Figure 90 & Figure 91*)
- 3 Take photography



In most of the case you will find long handled de-hooker and line cutter on board large scale tuna vessels. Short handled de-hooker and line cutter are most commonly found on board smaller vessels.



© NOAA

*Figure 89: Long handled device (from top): J-Style de-hooker, line cutter and de-hooker for ingested hooks*

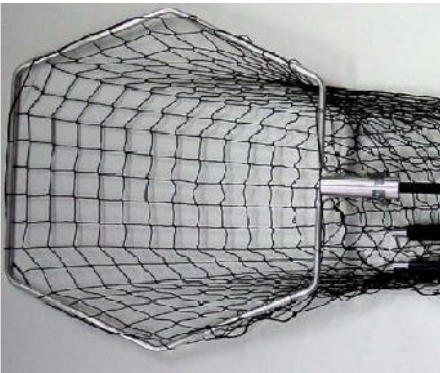

*Figure 90: Example of dip-net used to hoist the turtle on board*



© NOAA

© NOAA

*Figure 91: Hoisting of a turtle in a dip net on board a tuna longliner*

## Port State measures

Procedures for the implementation of the Indian ocean Tuna Commission

### Seabirds (Figure 92 & Figure 93)

Verify IOTC measures for seabird (Resolution 12/06)	
1	Ask to the master if he has caught seabirds and what are the two mitigation measures he is using (Night setting with minimum deck lighting, Bird-scaring lines - Tori Lines, Weighted branch lines)
2	Verify if the vessel has on board a "tori" bird scaring line
3	Note construction, streamer length and material and spacing and total length. Check to see if a towed object is used. Note if it has been recently used
4	Cross check with logbook the setting times to note if the vessel is setting during the day or night
5	Verify if weights are attached to the branch lines and if so the distance from the hook and approximate weight
6	Take photography

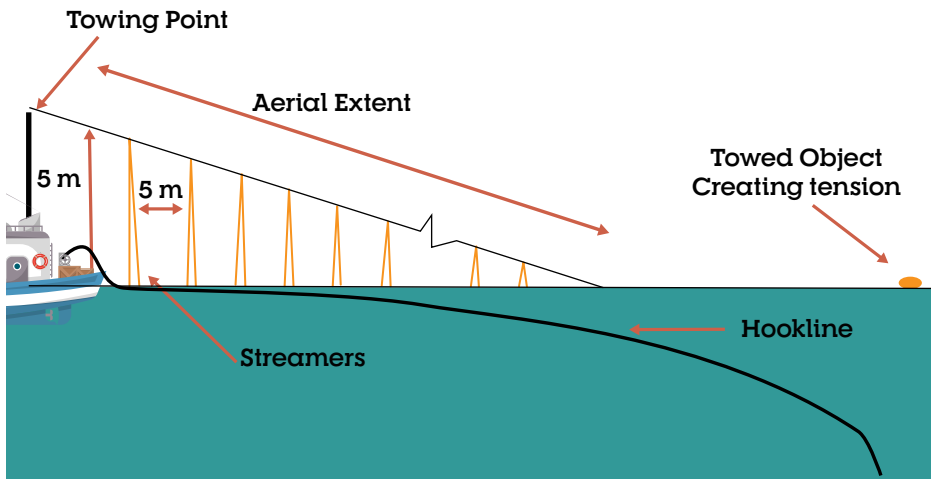

Refer to IOTC Resolution 12/06 Table 1 for full mitigation measures and Annex 1 for supplemental guidelines for design and deployment of tori lines.

Figure 92: Diagram of bird-scaring Streamer Line

Source: IOTC, 2021



Figure 93: Interaction with seabirds are more common below S 25 °

### Sharks fins (Figure 94, Figure 95 & Figure 96)

#### Verify IOTC measures for sharks (Resolution 17/05):

- 1 Request the master to produce the fresh sharks to verify that the fins are attached, and any frozen sharks to verify the total weight of sharks and weight of fins
- 2 Cross reference with the quantities of sharks recorded in the fishing logbook
- 3 Search for shark fins and, if found, determine the total weight and compare to the (offloaded) weight of shark trunks to see if the fins weight exceeds 5 percent of the total trunk weights

Sharks landed fresh: CPCs shall prohibit the removal of shark fins on board vessels. CPCs shall prohibit the landing, retention on-board, transshipment and carrying of shark fins which are not naturally attached to the shark carcass until the first point of landing.

## Port State measures

### Procedures for the implementation of the Indian ocean Tuna Commission

Sharks landed frozen: CPCs that do not apply sub-paragraph for all sharks shall require their vessels to not have on board fins that total more than 5 percent of the weight of sharks on board, up to the first point of landing. CPCs that currently do not require fins and carcasses to be offloaded together at the point of first landing shall take the necessary measures to ensure compliance with the 5 percent ratio through certification, monitoring by an observer, or other appropriate measures.



Figure 94: Shark fins drying on the upper deck of vessel

© IOTC

Shark fins can be hidden in any compartments of the vessel: fish holds, crew cabins, engine room, etc. Shark fins can be stored in sacks in the hold and/or dried on deck and then dry stored.

Search in area of the vessel where the environment is dry and hot, it is where shark fins are generally dried (engine room and chimney of the vessel).



Figure 95: Shark fins in bags

© IOTC



Figure 96: Packed shark fins

© IOTC

## Thresher sharks (*Figure 97, Figure 98*)

### Verify IOTC measures for thresher sharks (Resolution 12/09)

- |          |  |
|----------|--|
| <b>1</b> | Ask the master if he has caught thresher sharks and if they have been retained on board                                    |
| <b>2</b> | Check to see if there are any instances of thresher sharks rays catch recorded in the fishing logbook                      |
| <b>3</b> | While inspecting the fish holds, search for thresher sharks, trunk or fins, weight and record the quantity found on board. |
| <b>4</b> | Take photographs using reference measurements.   |

The inspection report form on Compliance with IOTC Conservation and Management Measures (Appendix X) provides the necessary fields to record the information related to protected and endangered species.

There are three species of thresher sharks: the common thresher shark, the bigeye thresher shark and the pelagic thresher shark. Consult the IOTC guide for identification of sharks to identify which species you have found on board.



© IOTC

*Figure 97: Caudal fin of thresher shark found on board a tuna longliner*



© IOTC

*Figure 98: Thresher sharks caught by a tuna longliner*

## Port State measures

Procedures for the implementation of the Indian ocean Tuna Commission

### Oceanic whitetip sharks (*Figure 99*)

Verify IOTC measures for thresher sharks (Resolution 13/06)	
1	Ask the master if he has caught oceanic whitetip sharks and if they have been retained on board
2	Check to see if there are any instances of oceanic whitetip sharks catch recorded in the fishing logbook
3	While inspecting the fish holds, search for oceanic whitetip sharks, trunk or fins, weight and record the quantity found on board.
4	Take photographs using reference measurements.

The inspection report form B on Compliance with IOTC Conservation and Management Measures provides the necessary fields to record the information related to protected and endangered species.

CPCs shall prohibit, as an interim pilot measure, all fishing vessels flying their flag and on the IOTC Record of Authorised Vessels, or authorised to fish for tuna or tuna-like species managed by the IOTC on the high seas to retain onboard, tranship, land or store any part or whole carcass of oceanic whitetip sharks.



*Figure 99: Oceanic whitetip shark caught by a tuna longliner*

## Cetaceans / Whale sharks (*Figure 100*)

### Verify IOTC measures for Cetaceans (Resolution 13/04) / Whale sharks (Resolution 13/05)

- 1 Ask the master if he has set the net a purse seine net around a cetacean/whale sharks and if the animal was sighted prior to the commencement of the set
- 2 Ask the master if he has reported the incident to the relevant authority of the flag State. The report must be shown to the inspectors (e.g. email, fax)
- 3 Check to see if there are any event of entanglement recorded in the fishing logbook.



© IOTC



© IOTC

*Figure 100: Brailling operations on a purse seiner*

## Mobulid rays (*Figure 101 & Box 44*)

### Verify IOTC measures for mobulid rays (Resolution 19/03)

- 1 Ask the master if he has caught mobulid rays and if they have been retained on board
- 2 Check to see if there are any instances of mobulid rays catch recorded in the fishing logbook
- 3 While inspecting the fish holds, search for mobulid rays, trunk or fins, weight and record the quantity found on board. Take photographs using reference measurements

## Port State measures

Procedures for the implementation of the Indian ocean Tuna Commission



© IOTC



© IOTC

**Figure 101:** Mobulid rays are listed in Appendix I and Appendix II of the Convention on the Conservation of Migratory Species of Wild Animals (CMS) and are also listed in Appendix II of the Convention on International Trade in Endangered Species of Wild Fauna and Flora (CITES)

### Box 44 | Example of contravention of IOTC Resolution on protected and endangered species

- The vessel does not carry on board line cutters and/or de-hookers and/or dip-nets.
- The shark fins weight exceed 5 percent of the total sharks trunk weights.
- There are thresher sharks on board the vessel.
- There are mobulid rays on board the vessel.
- There are oceanic whitetip sharks on board the vessel.



## **R** *Report completion*

**37, 38 and 39**

### **Action to be taken**

After the various elements of the inspection have been completed, the chief inspector is to convene a meeting of the inspection team to reconcile the findings of the inspection. The most important aspect of this process is to decide whether any violation of the national fisheries legislation or contravention of any IOTC Resolution has been discovered.

At the completion of the inspection a preliminary copy of the recorded information should be provided to the vessel's master.

Should there be any discrepancies or apparent infringements these must be clearly listed and cross referenced to both the relevant national and international legal instruments and IOTC Resolutions. Comments and reaction by the vessel master/crew members must be noted.

The chief inspector is to decide whether a suspected violation has been committed. If so, the master is to be read his rights under national law before any questions are asked. It is essential that the master acknowledges that he understands these rights. Use language cards if necessary. This is to be recorded in the inspection report or in the notebook.

Having read the master his rights, the chief inspector must explain the nature of the violation and request an explanation. Both the questions and the responses are to be recorded in the inspection report or the notebook for future use.

At this stage, the port State has two options as described in *Figure 109*.

## Port State measures

Procedures for the implementation of the Indian ocean Tuna Commission

**No offence  
has been  
detected**

**The port State can authorise the vessel to offload the catch and use the port.**

The chief inspector can inform its national authorities to grant offloading authorisation to the fishing vessel and make the necessary arrangement with the master to monitor the offloading of the catch

**Offence  
has been  
detected**

**The chief inspector directs the master not to offload catch or use the port until further advice is received from national authorities**  
The Chief inspector informs the national authorities who confirm denial of offloading of the catch and use of port facilities, and other relevant agencies are then informed (e.g. the port authority).

If an offence has been detected, the port State may take further actions against the vessel, owner and master based on national legislation and depending on the nature of the offence. It could include arrest, seizure and eventual confiscation of vessel, catch, gear and equipment, or an order to leave port. . The reaction and behaviour of the master and the crew to this decision should be noted - e.g., co-operative, aggressive, hostile.

Where action is taken to prevent off-loading or the taking of evidence or seizure/confiscation of catch and /or fishing gear these must be recorded in detail.

Source: IOTC, 2021

Figure 102: Inspection in port outcomes

## **S** *Signing the inspection report*

**39, 41 and 42**

### **Action to be taken**

The chief inspector and the master have to sign the inspection report.

Ask the master if there are any complaints at the way in which the inspection was carried out. Any complaint must be written out, signed, dated and stamped with the ship's stamp. Should the master refuse to sign, for any reason, a witness to this must be obtained.

In either case, yes or no, record that the master was asked this question. Thank the master for his co-operation and depart of the vessel.

### **6.3. Monitoring landing and transshipments in port**

Two processes fundamental to the implementation of the IOTC PSMR are:

- analysis of the information from the vessel's AREP **and the decision to deny or allow entry into the port;**
- when authorised to enter port, the port State is responsible for the **inspection of the vessel and monitoring of landing or transshipment** of the catch on board together with the completion of the port inspection report.

The results of the assessment of the AREP and the RAR provide a basis for determining whether or not the vessel may enter port. If port entry is authorised, it should activate procedures for inspection of offloading or transshipment of the catch. This is important to validate documented catch and the species composition reported in the vessel's logbook(s) and transshipment declarations.

Inspections of fish wells on a purse seiner or refrigerated holds on longline and carrier vessels are difficult to undertake for practical reasons, and highly unlikely to provide accurate information of the weight and species of

## Port State measures

### Procedures for the implementation of the Indian ocean Tuna Commission

the fish on board. Therefore, monitoring the whole landing or transshipment process is an essential component of the "inspection team's" tasks. After the vessel has been offloaded, the holds and storage wells should be inspected to record any remaining fish on board.

Knowledge of the products and procedures used to offload or tranship the catch from different types of vessels and of methods to sample and verify the weight and species composition are important. It assists inspectors to plan ahead and successfully monitor these operations in port.

Subsequently, all the information from the offloading operation is captured in the inspection report (fields 30 and 31) and compared to the information reported in the AREP. If, at this stage, there is any evidence that the vessel has engaged in IUU fishing or related activities it should be denied further use of port.

Essentially, offloading to a shore facility or transshipment to another vessel requires similar monitoring procedures. The main difference is that discharge to a shore facility is likely to provide further opportunity to record the species composition and weight of the catch offloaded (*Figure 103*).

Monitoring transshipment provides less opportunity to weigh fish but does provide means to verify the numbers of fish and identify species thereby highlighting any substantial level of misreporting in logbooks or transshipment declarations.

Offloading can take several hours to more than a day. It is, therefore, a process that will optimally be monitored by a team of inspectors working together in shifts to observe the entire process.



*Figure 103: Fish in a vessel hold and offloading operation*

### **6.3.1. Preparation and planning offloading operations**

Advanced planning and preparation of documents and equipment are an essential component for successful port State inspections. A detailed check of equipment and documentation should be prepared in advance, taking into consideration the vessel type, catch and conditions in the port (*Box 45*).

When conducting inspections, CPCs are required *"to make all possible efforts to avoid unduly delaying the vessel and to minimise interference and inconvenience that including any unnecessary presence of inspectors on board, and to avoid action that would adversely affect the quality of the fish on board."*(IOTC PSMR paragraph 11.2(f)).

However, inspectors should not be intimidated by this requirement nor subject to pressure from the vessel operators, especially when inspecting vessels categorised in the AREP assessment as "high" or "medium" risk or where inspection of the catch documentation aroused suspicion of potential misreporting.

**Box 45 | Monitoring of landing and transhipment - preparation checklist**

**1. Documentation**

- cargo manifest / hold plan / well plan
- catch and product logs
- data forms

**2. Equipment**

- clipboard
- scales
  - platform
  - hanging spring scale
- measuring tape
- callipers
- torch
- camera

**3. Protective Clothing**

- eye protection
- hard hat
- reflective jacket
- safety boots
- gloves
- freezer suit

Working documents and information for monitoring the offloading are provided in *Figure 104*.

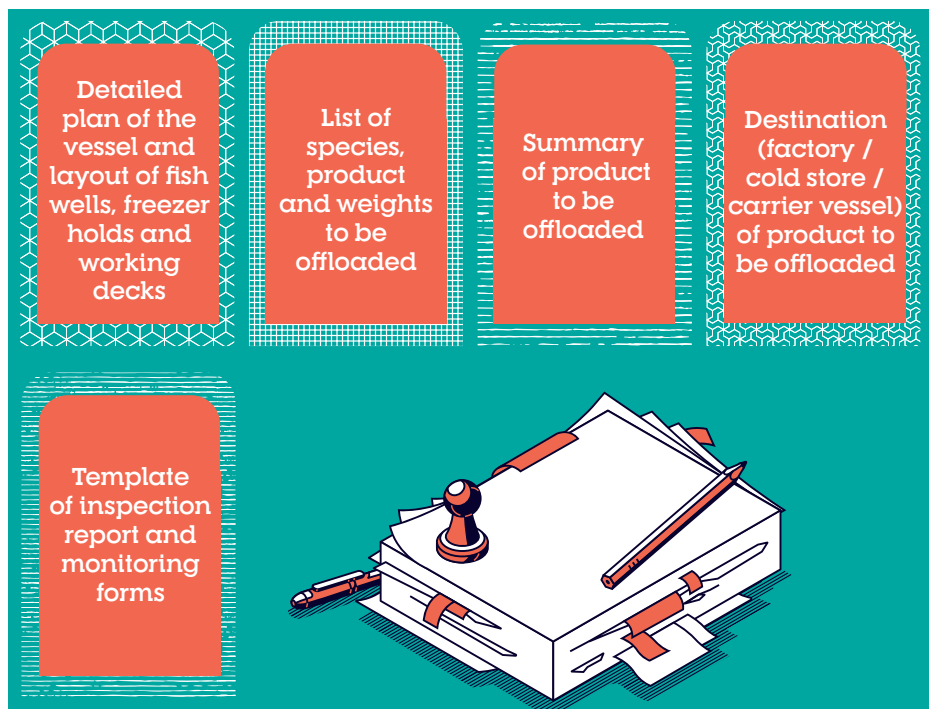

Source: IOTC, 2021

*Figure 104: Essential working documents to prepare the monitoring of offloading of the catch of a vessel*

The AREP requires the vessel to provide information on quantities and species composition of the fish onboard. In addition, after entering port and prior to the vessel commencing with offloading, inspectors must be given a copy of the manifest of product to be offloaded. This will also be required by the port authorities and stevedores manning the operation.

To further assist with monitoring, the inspectors should obtain all documentation related to the catch recorded and stored on board that includes inter alia, those presented in *Figure 105*.

## Port State measures

Procedures for the implementation of the Indian ocean Tuna Commission



Source: IOTC, 2021

**Figure 105:** Essential vessel working documents to check for the monitoring of offloading of the catch of a vessel

Details on the species, product and quantities in freezer holds and fish wells will assist in planning sampling strategies during the offloading operation.

### Monitoring Stations

Several key positions can be manned to monitor offloading (1 to 4), these are presented in [Figure 106](#).



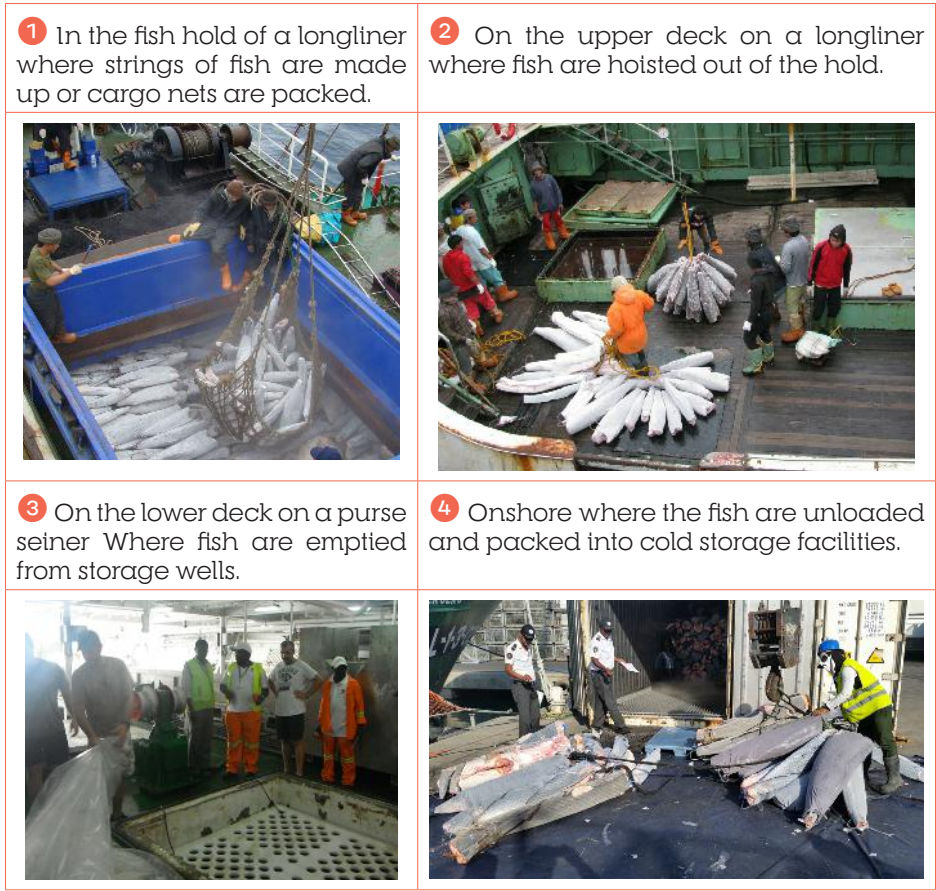

Figure 106: Example of key positions to monitor offloading

Monitoring positions need to provide a clear view of the product being offloaded and facilitate counting the number of units and determine weights and species composition. For both transshipment and landing to shore, inspectors need to station themselves where they can visually monitor the fish being hoisted out of the hold and for the maximum period that hoists are visible in the air.

## Port State measures

### Procedures for the implementation of the Indian ocean Tuna Commission

The product being landed to a shore facility is often weighed and repacked. Monitoring this area, where the hoist is put down and fish are emptied out of the cargo net provides a controlled environment where the fish can be counted, identified and weighed.

### *Information and recording*

Offloading forms will be designed to capture information continuously throughout the offloading process. Examples of these are provided in appendix XI. At the completion of the offloading the figures have to be recorded in the port inspection report (fields 30 and 31). A description of the information to be recorded is summarised in *Table 30*.

*Table 30 - IOTC port inspection report - Fields 30 and 31*

Field Number: 30	Evaluation of offloaded catch (quantities)
Species	<p>The fish offloaded will have to be monitored and where necessary sampled to verify the number and weight of each species.</p> <p>The species must be recorded using the ASFIS 3-alpha codes (known as FAO species codes).</p> <p>For example: <b>YFT</b> for yellowfin tuna (<i>Thunnus albacares</i>)</p>
Product form	<p>The product form of each species offloaded must be recorded, either processed or not (e.g., skinless, boneless fillets frozen; head off, split salted; whole refrigerated in seawater).</p> <p>The processing codes for different species are provided in the species identification guide.</p>
Catch Area (s)	<p>Inspectors must obtain from the vessel records of the geographical/statistical area where the catch being offloaded was taken. Reference the statistical codes or geographical coordinated used to report catch in the logbook.</p>
Quantities declared	<p>The vessel has to declare the quantities of fish (by species) that it has onboard and the quantities that will be offloaded. This information must be provided to the inspector prior to any product being offloaded and must be entered onto the inspection report.</p>
Quantities offloaded	<p>The inspectors must report the quantity (by species) that they record being offloaded.</p>
Difference between quantity declared and quantity offloaded	<p>The inspectors must determine the difference between the declared quantities to be offloaded and the quantities that they record being offloaded.</p> <p>For example:</p> <p><i>YFT declared to be offloaded: <b>65 tonnes.</b></i></p> <p><i>YFT recorded by the inspectors offloaded: 80 tonnes</i></p> <p><i>Difference is (80 - 65) equals 15 tonnes more than the declared quantities offloaded.</i></p>

## Port State measures

Procedures for the implementation of the Indian ocean Tuna Commission

Table 30 - IOTC port inspection report - Fields 30 and 31

Field Number: 31	Catch retained on board (quantities)
Species	<p>The fish retained onboard after offloading must be listed by weight for each species.</p> <p>The species must be recorded using the ASFIS 3-alpha codes. For example: <b>OIL</b> for Oilfish (<i>Ruvettus prestiosus</i>)</p>
Product form	<p>The product form of species retained must be recorded, either processed or not (example <i>WHO</i> for whole frozen fish. <i>GGT</i> for fish with gill, guts and tail removed. Other products could be skinless, boneless fillets frozen; head off, split salted; whole refrigerated in seawater).</p> <p>The processing codes for different species are provided in the species identification guide.</p>
Catch Area (s)	<p>Inspectors must obtain the relevant geographical/statistical area where the catch retained onboard was taken. Reference the statistical codes or geographical coordinates used to report catch statistics.</p>
Quantities declared	<p>The vessel must declare the quantities of fish (by species) that it will retain on board.</p>
Quantities offloaded	<p>The inspectors must record the total quantities that they monitored being offloaded. Means of estimation must be kept to assist in verification of figures calculated.</p> <p>The inspectors must also report the quantity (by species) that they record retained on board. This will require a physical inspection of the hold.</p>
Difference between quantity declared and quantity offloaded	<p>The difference between the declared quantities offloaded and retained and the quantities that are monitored being offloaded together with the quantities recorded remaining in <b>the hold</b>. These differences must be recorded.</p>

### 6.3.2. Landing from tuna longline vessels to shore or transhipping to a carrier vessel

#### Introduction

Longline vessels and smaller transport vessel with fish or processed products often tranship all or part of their catch in port to larger carrier vessels. The procedures and preparation for monitoring transhipments from one vessel to another is essentially the same as for landing to a factory or cold store ashore.

Large Scale Tuna Longline Vessels, (LSTLV) target larger tuna and swordfish. These fish are processed immediately after being caught and individually deep frozen. Prior to freezing a short rope loop is threaded through the tail to facilitate stringing frozen fish together for offloading.



© IOTC

Figure 107: Direct offloading of tunas

The fish holds on longliners are packed as the fish are caught and a single hold is likely to contain a mix of fish species and a range of different sizes. This will be reflected during the landing or transhipment.

Inspectors must request a manifest of the number and species of fish in the hold. Analysis of the number of fish and total weight per species will provide an estimate of the average sizes of the fish. Monitoring strings of individual fish provides the opportunity to count the number of fish being offloaded and species or groups of like species and products can be identified.

## Port State measures

### Procedures for the implementation of the Indian ocean Tuna Commission

Depending on the size of the longline vessel and on the product there are three main methods to offload:

1. direct transfer: when fish in "strings of individual fish units" are taken from the holds of the fishing vessel using dockside or carrier crane (*Figure 107, Figure 108, Figure 110*);
1. indirect transfer: where "strings of individual fish units" are first hoisted from fish hold using the fishing vessels gear and then combined into a larger string to be hoisted off the vessel using a crane ashore or on the carrier vessel (*Figure 111*);
2. indirect method: use a cargo net which is packed on board the fishing vessel (*Figure 109, Figure 114*).



*Figure 108: Small batches of frozen tunas*

Vessels with large hatch openings are most likely to hoist directly from their hold to the quayside or a carrier vessel. This is a rapid process that does not provide much opportunity to monitor the number and weight or species of the fish being offloaded.

On vessels where hatches are too small for a direct hoist, fish are first hoisted in small batches onto the deck using the vessels own equipment. This provides a good opportunity to count the number of fish and record species (*Figure 100*). A number of these batches are then combined into a large sting for transfer to shore using the dockside crane for transshipment to a carrier vessel.



*Figure 109: Transshipment of tunas in a cargo net*

Longline vessels may split their catch for offloading. Larger tuna and processed swordfish and by catch such as marlin and shark trunks are offloaded ashore or transhipped in strings of individual units to a carrier vessel. Following this, the small tuna and by catch species are offloaded using a cargo net.

© IOTC It is more difficult in counting and identifying fish accurately in the cargo net during a hoist. The inspectors will need to monitor positions either where the net is packed on the fishing vessel, keeping in

mind that this may be in the hold of the vessel, or monitor the cargo net being set down ashore, where it can be weighed and unpacked from the net.

Transshipment operations provide fewer opportunities to count and identify species. Inspectors monitoring transshipments must select a position where they can observe the fish being hoisted out of the fishing vessel hold and where the strings of fish are visible in the air for the maximum amount of time. In the time the fish are visible, an accurate estimate of the number of fish as well as the species composition should be determined. Due to the

## Port State measures

### Procedures for the implementation of the Indian ocean Tuna Commission



© IOTC

*Figure 110: Direct offloading*

processing method and fish being partially obscured in the hoist, it may not be possible to accurately identify species. In these situations an aggregation of two or more species may be recorded. (e.g., yellow fin and bigeye combined).

The larger LSTLVs with high value sashimi grade fish will prefer a direct transfer of fish from the hold of the fishing vessel to the hold of the carrier vessel. This can be a rapid process with individual strings being visible for less than a minute and often the fish are obscured by a mist that surrounds the hoist.

Longline vessels offloading in port may also split their catch, with higher valued and larger fish being transhipped in strings to a carrier and following the transhipment the smaller by catch species are offloaded to shore in cargo nets.

Due to practical difficulties to count and identify fish in a cargo net hoist, the inspector must monitor from a position either where the cargo net is loaded on board or offloaded ashore.





*Figure 111: Fish being aggregated on the deck of small longline vessel and a combined hoist being transferred to a carrier vessel*

### ***Sampling procedures to determine the weight of the fish landed or transhipped***

Three basic methods can be used to estimate the weight of fish being landed or transhipped from a vessel.

1. Use an independent means of weighing that can include a hook-scale attached to the crane hook to record the total weight of a hoist or have a platform scale or drive-on scale ashore where the entire catch offloaded or transhipped is weighed.
2. Randomly select and weigh samples of individual fish from different species and size categories and raise the number of units counted by the average weights.
3. Use the declared weights and numbers provided by the vessels to calculate an average unit weight per species and raise the number of units counted by these average weights.

## Port State measures

### Procedures for the implementation of the Indian ocean Tuna Commission

The independent assessment and level of accuracy when determining landing or transhipped weights will be dependent on the method used (Figure 112, Figure 113). Weights recorded independently by the inspector using a hook scale or weighing selected samples of the fish will be preferable to using only information provided by the vessel. However, there are clear advantages and disadvantages as well as practical implications for using each of these methods.



© IOTC



© IOTC



© IOTC



© IOTC

Figure 112: Weighing of tunas and striped marlins in port

A hook scale works well in stable condition in port and most carrier vessels use these for their own records. A disadvantage is that if species are mixed then the average weight for a particular species cannot be calculated. However, it is often possible to get accurate weights for like species and in the event of a single species strings an average weight for that species will be obtained. With cooperation from the vessel individual fish can also be weighed on a hook scale (*Figure 113*).



*Figure 113: Hook scale*

Sampling individual fish randomly on a species level has the advantage of providing an average size for each of the species. Implemented randomly throughout the landing or transshipment process, it can also be adapted to accommodate variability in different size classes of a species.

© IOTC The main disadvantage of this method is the difficulty of weighing large fish (over 50kg) that are also hazardous to handle in their frozen condition. Due regard must also be given to the deterioration of a high value product exposed to high temperatures for any prolonged time.

## Port State measures

### Procedures for the implementation of the Indian ocean Tuna Commission

Using the number and weights declared by the fishing vessel has the least practical implications for handling fish but does not provide a totally independent estimate of weights landed or transhipped. It will provide a useful guide to inspectors and together with accurate counts of units transhipped it will highlight any significant discrepancies in declared quantities.



The string of fish is hoisted out of the fishing vessel hold.



The string of fish is positioned on the cargo net.



The cargo net is hoisted out of the fishing vessel to the carrier vessel.

Calculations using conversion factors are presented in **Box 46** and Procedures for inspection and monitoring offloading from tuna longliner are summarised in **Table 31**.

### Box 46 | Monitoring of landing or transhipment - using conversion factor

#### Summary of observed product offloaded

Common Name	Scientific name	Average weight (kg)	Total unit count	Calculated weight offloaded
Albacore	Thunnus alalunga	23.62	560	13227
Big eye tuna	Thunnus obesus	55.03	1100	60533
Swordfish	Xiphias gladius	51.00	55	2805
Blue marlin	Makaira nigricans	87.56	30	2626
Sailfish	Istiophorus albicans	13.42	10	134
Blue shark	Prionace glauca	35.00	150	5250
Mako sharks	Isurus spp	17.67	75	1325
Totals offloaded			1980	85901

*Total weight of product offloaded (per species); equals average unit weight multiplied by total unit count.*

**Albacore:  $23.62 \times 560 = 13227$  kg (13.227 tonnes)**

*The product weights can then be raised using the conversion factor (raising factor) to determine the live weight caught. These weights provide a cross-referenced to the logbook records of live catch weights recorded.*

Common Name	Total weight offloaded	Processing Code	Raising Factor	Calculated live weight
Albacore	13227	GGT	1.09	14418
Big eye tuna	60533	GGT	1.09	65981
Swordfish	2805	HDD	1.33	3731
Blue marlin	2626	TAL	1.43	3756
Sailfish	134	TAL	1.43	192
Blue shark	5250	HDD	1.33	6983
Mako sharks	1325	HDD	1.43	1895
Totals	85901			96955

*Live weight equals product weight multiplied by the raising factor for the processing code.*

**Albacore tuna processing code GGT, raising factor 1.09**  
**Recorded albacore product weight offloaded 60533 kg**  
**Live weight:  $13227 \times 1.09 = 14418$  kg (14.42 tonnes)**

## Port State measures

### Procedures for the implementation of the Indian ocean Tuna Commission

Table 31 - Procedures for inspection and monitoring offloading from tuna longliner

Arrival on the vessel	Introduction and briefing with Master / Fishing Master / Bosun by the inspection team leader and presentation of inspectors' identifications and mandate.
Request for documentation	Inspectors monitoring offloading must request: <ul style="list-style-type: none"><li>→ confirmation of quantities to be offloaded or transhipped as reported in the AREP;</li><li>→ fish hold plan showing dimension;</li><li>→ loading plan showing product location, quantities and species in hold.</li></ul>
Request details of offloading plan and procedure	Request details of method and procedures that will be followed when offloading out of the hold to shore or during transshipment. <ul style="list-style-type: none"><li>→ Note if fish will be discharged in strings or using a cargo net.</li><li>→ Note if selected products and species will be discharged in different sequences. <i>Example; large tuna in strings, transhipped to a carrier vessel. By-catch offloaded to shore in cargo nets.</i></li><li>→ Discuss option of tuna-like species being offloaded together in single hoists to facilitate recording species composition of the catch.</li></ul>
Discuss planned sampling of catch for verifying weight and species composition	Discuss need to record sample weights and identify species. Determine where inspection points will be set up and where sampling can be undertaken to cause least disruption to offloading operations. Ask if a hook scale will be used and request its use if available
Inspection of hold before offloading operation	Undertake an advanced inspection of hold and compartments where fish are stored to record to what capacity they are filled and take photographs. At this stage note and record processing state and species that can be identified.

<p>Setup monitoring position(s)</p>	<p>Select a position where the fish being hoisted out of the hold can be observed; counted and species identified. Consideration should be given to manning more than one position to observe offloading process. When selecting positions note health &amp; safety requirements with respect to fish falling from hoists or collapse of the crane. (These often occur)</p> <p>Possible positions</p> <ul style="list-style-type: none"> <li>→ on the deck of the fishing vessel below the shelter deck with full view of the hatch;</li> <li>→ on the deck of the carrier vessel where fish can be observed coming out of the longline vessels hold and being lowered into the carriers vessels hold;</li> <li>→ on the quayside where the deck is visible and where hoists can be observed in the air and where they will be set down;</li> <li>→ in the factory ashore where hoists are set down.</li> </ul> <p>Note: positions should allow opportunity to read hook scale if attached.</p>
<p>Sampling for average weight</p>	<p><u>Hook Scale attached:</u> record the weight of each hoist. <u>No hook scale attached:</u> at random intervals request a single or number of fish from a hoist to weigh.</p> <ul style="list-style-type: none"> <li>→ Random number tables can be computer generated to facilitate these selections.</li> <li>→ Weight using a hanging or platform scale depending on what's available and the size of the fish.</li> <li>→ Request use of the hook scale for large fish.</li> </ul>
<p>Sampling for species composition</p>	<p>Larger tuna that have been processed in a similar manner may be difficult to identify when together in a hoist. These can be recorded as an aggregation for the different species.</p> <p><i>Example. YFT and BET mixed.</i></p> <p>To determine the ratio of the two species request randomly selected hoist to be lowered to the deck and sample for the different species from closer examination of the stomach cavity. The ratio of the species mix can be raised to the total unit count, however this will only provide a rough indication.</p>

## Port State measures

### Procedures for the implementation of the Indian ocean Tuna Commission

<b>Monitoring Hoists</b>	Using offloading or transshipment forms, record details of each hoist. <ul style="list-style-type: none"><li>→ Record the date / time of first hoist.</li><li>→ Record for each hoist; the number of fish, species and product.</li><li>→ Record hook scale weight (if attached).</li><li>→ Number each hoist consecutively from the first to the last.</li><li>→ Take photographs of hoists where species are not clearly identified.</li><li>→ Record start and end time of interruptions in the offloading due to meal breaks or technical difficulties.</li><li>→ Record the date / time of the last hoist.</li></ul>
<b>End of offloading and transshipment operations</b>	Summarise quantities recorded offloaded for: <ul style="list-style-type: none"><li>→ species;</li><li>→ processing code.</li></ul> Apply the raising factor for different processing codes. <ul style="list-style-type: none"><li>→ Request copy of the offloading declaration-form.</li></ul> Compare the recorded quantities with those declared by the vessel and note difference.
<b>Hold inspection</b>	Request a vessel officer to accompany inspector for an inspection of the hold after offloading operations. Note: <ul style="list-style-type: none"><li>→ hold divisions;</li><li>→ freezer compartments on level of fishing deck.</li></ul> Record number, species and weight of fish remaining in the hold. Record how estimates of remaining fish are determined: <ul style="list-style-type: none"><li>→ Visual count,</li><li>→ Fish weighed,</li><li>→ Volume of hold calculated and compared to volume of remaining fish.</li></ul> Photograph empty hold or remaining fish in hold. Request a declaration from the vessel of the quantity of fish remaining in the hold. Record difference between recorded and declared quantities.
<b>Reconciliation</b>	Complete inspection report fields 30 and 31.
<b>Debriefing with vessel master / fishing master</b>	Debrief responsible persons on board and provide copies of recorded quantities monitored, allowing their comments and signatures to be appended.



### 6.3.3. Offloading from purse seine vessels

#### Introduction

Fish caught on purse seine vessels are unlikely to be processed and the main target species and commercial valued by-catch are usually brine frozen in their whole state. At the time of brailing fish are often sorted into size and species classes for brine freezing to meet the market or factory requirements. It is therefore likely that juvenile yellowfin, bigeye and longfin (less than 10kg) will be mixed together with skipjack tuna of the same size. Larger yellowfin tuna and bigeye tuna may be separated and frozen or both species of similar size frozen together.



© IOTC

Figure 115: Inspection of a fish hold on a purse seiner

On industrialised purse seiners, the tunas are preserved in wells of 20 to 40 tonnes each, (total 800 to 2 000 tonnes) with brine freezing at -20 °C. In smaller artisanal purse seiners, tuna are generally kept in iced seawater.

Prior to offloading, inspectors must request a "well loading plan" with the details of the catch in each well. This will assist in planning their sampling of the fish as wells are emptied (*Figure 122*).

The placement of the catch in the storage wells below deck should correspond to specific well numbers. Note each well has a designated number preceded with the letter S or P depending on the location on the starboard or port side. Example "P6" would be well No. 6 on the port side.

The recording of the well loading sequence by the inspectors is important for identifying fish species and sizes while offloading or transshipping. The inspector should consult both the fishing master and the chief engineer to obtain this information before they start the operations.

## Port State measures

Procedures for the implementation of the Indian ocean Tuna Commission

### Monitoring positions

The discharge process on a purse seine entails emptying storage wells onto a conveyer that moves the fish to a cargo net to be hoisted ashore or over to a carrier vessel. The fish are often resorted into their species and weight categories at this stage (Figure 81).

To record the species and weight being discharged inspectors must position themselves in a location where they can observe the fish being discharged from the fish wells or being loaded into cargo nets for hoisting off the vessel (Figure 116).

The monitoring positions must provide a clear view of the fish and allow the following information to be recorded:

- measuring lengths (Figure 115);
- subsampling fish to determine an average unit weight.



© IOTC

© IOTC

Figure 116: Monitoring tuna offloading on a purse seiner

### ***Sampling procedures to determine average weigh of the fish***

An independent verification of the weigh and species composition of the catch offloaded or transhipped is one of the main objectives of the inspection team. Several processes can be followed to obtain these objectives:

- estimating volume of fish in cubic meters in the fish wells;
- counting the number of fish offloaded and raising this by an average fish weight;
- recording the weight of each hoist.

The well plan should provide details of the volume of each well and the well loading plan should also give details of the species and size class of fish in each well. A visual estimation of the level of fish can provide a rough estimation of the weight of fish in the well.

Fish emptied out of a well normally pass on a conveyor belt to where they are packed into a cargo net, (*Figure 117*) for hoisting ashore or over to a receiving vessel. The number of fish can be monitored by either counting all the fish as they pass on the belt for the entire offloading period or estimating the offloading rate (i.e. number per minute by counting all the fish for a set time and multiplying this by the total time that it takes to offload the well.

To obtain an average weight of the fish from a well, select every  $n$ th fish off the belt, record the individual weights using a spring or platform scale (the length of the fish can also be measured at this stage). This process should be repeated several times, especially if there is a noticeable change in size.

Calculate the total weight of the sample by adding all the weights of the fish sampled from the well. The total weight is then divided by the number of fish sampled to obtain an average weigh per fish for that specific well. *Box 47* shows a method of calculating total weight.

## Port State measures

Procedures for the implementation of the Indian ocean Tuna Commission

### Box 47 | Monitoring of landing and transshipment - calculation of total weight

#### 1. Calculation for total number of fish in a well

*Sample count: Forty-five (45) fish counted per minute of belt time. Total belt running time; 15 minutes.*

*Total number of fish in the well equals; number of fish per minute multiplied by the total belt time to offload a well.*

$$\text{Number of fish: } 45 \times 15 = 675 \text{ fish}$$

#### 2. Sample and calculation of average weight per fish

Sample No. (individual fish)	Weight (kilograms)
1	5.6
2	4.8
3	6
4	5.8
5	4.7
Total weight	26.9 kg
No. fish sampled	5
AVG Wt.	Total Wt. / No. fish)
	(26.9 / 5) = 5.38 kg

3. Total weight of fish in the well equals; Total number of fish multiplied by the average fish weight.

$$\text{In this example: } 675 \times 5.38 = 3631.5 \text{ kg (3.63 tonnes)}$$

Purse seine operators can only accurately record their total catch at the time of offloading and may also obtain these figures by recording the weight of each hoist using a hook-scale or a platform scale when the fish are offloaded into the factory.

### ***Determining the species composition from visual subsampling fish on the conveyor***

The species composition being landed or transhipped needs to be verified to crosscheck with the vessels reported catch. Ideally the fish can be separated into the different species categories before being offloaded and the weight of each species recorded as they are hoisted off the vessel.

Alternatively, sub-samples of the fish being offloaded must be taken to estimate the ratio of the different the species. This can be done by recording the species for a predetermined time as the fish pass on the conveyor belt or taking random samples of fixed number of fish at regular intervals. This ratio can is then raised to the total time the belt is in operation to empty the well or applied to the total recorded number of fish offloaded (*Box 48*).



© IOTC



© IOTC

*Figure 117: Tuna on the conveyor belt of a purse seiner*

Otherwise record the species composition for a single hoist and raise the ratio with the number of hoists to empty the well. To improve accuracy the process should be repeated as often as possible.

Monitoring the offloading may also be carried out onshore, recording the number of hoists and estimated weight per hoist to calculate the total tonnage offloaded.

## Port State measures

Procedures for the implementation of the Indian ocean Tuna Commission

### Box 48 | Determine species composition

*For example species observed in a predetermined time:*

Species recorded	Sample time	No. counted per spp.	
Start Obs time	10:30	SKJ	45
End Obs time	10:35	YFT	3
Total Obs Time	5 minutes	BET	5
Total Belt time to fill net	15 min	ALB	12

*Calculation: Ratio for observed time*

*Total No. per Spp equals*

*[Obs No. spp count multiplied by Total belt time] divided by [Obs time]*

*For example: Total No. SKJ. = [45 X 15] / 5  
= 135 SKJ*

Species sampled	No. counted per spp.	Raised total No. / spp in well
SKJ	45	135
YFT	3	9
BET	5	15
ALB	12	36
Total (check)	65	195

*Table 32 - Procedures for inspection and monitoring offloading from tuna purse seiner*

Arrival on the vessel	Introduction and briefing with Master / Fishing Master / Bosun by the Inspection team leader and presentation of inspectors' identifications and mandate.
Request for documentation	<p>Inspectors monitoring offloading to:</p> <ul style="list-style-type: none"> <li>→ confirm quantities to be offloaded as reported in the AREP;</li> <li>→ request a "well loading plan";</li> <li>→ note dimensions and well volumes from the well plan;</li> <li>→ note species size and corresponding set numbers loaded in specific wells;</li> <li>→ Note condition of fish in wells: brine frozen, chilled sea water.</li> </ul>
Request details of offloading plan and procedure	<p>Request details of method and procedures that will be followed when offloading</p> <ul style="list-style-type: none"> <li>→ Note sequence that wells will be offloaded.</li> <li>→ Discuss option of "tuna-like-species" being offloaded together.</li> </ul>
Discuss planned sampling of catch for verifying weight and species composition	<p>Discuss need for recording sample weights and species</p> <ul style="list-style-type: none"> <li>→ Determine where these can be undertaken to cause least disruption to offloading operations.</li> <li>→ Location where platform scales can be set up and space to measure fish.</li> <li>→ Ask if a hook scale will be used and request one if available.</li> </ul>
Inspection of hold before offloading operation	<p><u>Undertake an advanced inspection of fish wells and record:</u></p> <ul style="list-style-type: none"> <li>→ estimated volume of fish in each well;</li> <li>→ fish size in each well, for example less than 10kg or more than 40kg.</li> </ul> <p>If possible, note the species mix in a well and take photographs of each well before it is offloaded.</p>

## Port State measures

### Procedures for the implementation of the Indian ocean Tuna Commission

<p>Setup monitoring position(s)</p>	<p>Setup monitoring position(s) from where the offloading or transhipment will be observed and where sampling will take place. Preferably more than one position should be manned. Select a position where the fish coming out of the well can be monitored.</p> <ul style="list-style-type: none"><li>→ This may be alongside the well as fish are raised from the well to a conveyor.</li><li>→ A position next to the conveyor from wells to loading point for hoisting ashore.</li><li>→ On the quayside where the deck is visible and where hoists can be observed in the air and are set down.</li><li>→ In the factory where hoists are set down. Consideration should be given to manning more than one position to observer offloading process. Position to sample fish and another to estimate total weight being offloaded.</li></ul> <p>When selecting position note health &amp; safety requirements with respect to fish falling from hoists or collapse of the crane (these often occur).</p>
<p>Sampling for average weight</p>	<p>Depending on the sampling position set up, select fish at random intervals</p> <ul style="list-style-type: none"><li>→ Random number tables can be computer generated to facilitate these selections.</li><li>→ Weight using a hanging or platform scale depending on what's available and the size of the fish.</li><li>→ Request use of the hook scale for large fish.</li><li>→ The number of fish sampled will be determined by the variability in size (size range) and total estimated number of fish onboard. Smaller fish are often more uniform in size and a smaller subsample can be selected to provide an accurate average weight. For example; selecting 1 fish for every 100.</li></ul>
<p>Sampling for species composition</p>	<p>This can be done by recording the species for a predetermined time as the fish move past or taking random samples of fixed numbers at regular intervals.</p> <ul style="list-style-type: none"><li>→ Optimally if fish are passing on a conveyor belt, request they stop the belt for a short period and sample a length of the belt. Use this ratio raised to the total time that the belt is in operation to empty a well.</li><li>→ Alternatively record the species composition for a single hoist and raise the ratio with the number of hoists to empty the well.</li><li>→ To improve accuracy the process should be repeated as often as possible.</li></ul>



Monitoring Hoists	<ul style="list-style-type: none"> <li>→ Record the date / time of first hoist.</li> <li>→ Record for each hoist the number of fish, species and product.</li> <li>→ Record hook scale weight (if attached).</li> <li>→ Number each hoist consecutively from the first to the last.</li> <li>→ Record start and end time of interruptions in the offloading due to meal breaks or technical difficulties.</li> <li>→ Record the date / time of the last hoist.</li> </ul>
End of offloading and transhipment operations	<p>Summarise quantities recorded offloaded for:</p> <ul style="list-style-type: none"> <li>→ species;</li> <li>→ processing code (should be 1 for purse seine vessels offloading whole fish).</li> </ul> <p>Apply the raising factor for different processing code; Request copy of the offloading declaration-form. Compare the recorded quantities to that declared by the vessel and note difference.</p>
Well inspection	<p>Request a vessel officer to accompany inspector for an inspection of the wells after offloading operations. Note well number and estimate quantities of any fish left in the well. Record how estimates of remaining fish are determined: visual count;</p> <ul style="list-style-type: none"> <li>→ fish weighed;</li> <li>→ volume of hold calculated and compared to volume of remaining fish.</li> </ul> <p>Photograph empty wells or remaining fish in hold. Request a declaration from the vessel of the quantity of fish remaining in the hold. Record difference between recorded and declared quantities.</p>
Reconciliation	Complete inspection report fields 30 and 31.
Debriefing with master / fishing master	Debrief responsible persons on board and provide copies of recorded quantities monitored, allowing their comments and signatures to be appended to the inspection report.

### **6.3.4. Offloading from carrier vessels**

#### **Introduction**

The IOTC PSMR requires the monitoring of the entire landing or transshipment from carrier vessels, as well as fishing vessels in port. It requires a cross-check between the quantities by species recorded in the prior notice of landing and the quantities by species landed or transhipped and, on completion, verification of the quantities by species of fish remaining on board.

Carrier vessels can range in size from less than 100 tonnes to over 6000 tonnes that will offload more than 2000 tonnes of fish. Larger carrier vessels can have multiple holds with several deck layers in each hold. Smaller carrier vessels are often converted fishing vessels that enter port to tranship to a larger carrier vessel for transport to international markets.

The major difference between a carrier and fishing vessel is that, for carrier vessels, all the fish on board were received from previous transshipments and detailed information for each transshipment must be recorded in the AREP field numbers 20 to 21.

The objectives in port inspections are to verify the information provided in the AREP and record these results of the inspection in the port inspection report (fields 28 and 29).

Details of the report requirements include:

| (Field 28 - Relevant transshipment authorisation(s)) that includes:

- donor vessel identifier, (for example IOTC No.)
- validity of the transshipment authorisation
- issuing authority from the vessels flag State.

(Field 29 - Transshipment information concerning donor vessels) that includes)

- donor vessel name
- ID No.
- produce form for each species
- quantities
- flag State
- species transhipped
- catch Area.



© IOTC



© IOTC

**Figure 118:** Fish from different donor vessels separated in the fish hold of a carrier vessel

Essentially discharging fish from a carrier vessel is similar to offloading a fishing vessel with the exception that there are significantly larger quantities of fish. There is also the possibility of catch being offloaded from more than one hold simultaneously so that several positions will have to be manned at one time to monitor the entire operation. The entire operation will require a team of personal working shifts.

## Port State measures

### Procedures for the implementation of the Indian ocean Tuna Commission

Several scenarios that may be encountered when landing or transshipping between carrier vessels:

- large multi-hold carrier vessels, landing to shore that involve several thousand tonnes of fish;
- small carrier vessel offloading from a single hold, less than 1000 tonnes;
- carrier vessel transshipping to another carrier vessel.

Smaller carrier vessels transshipping will essentially follow the same monitoring procedure as a longline vessel. Monitoring the landing of large multi-hold carrier vessels will be a more complex operation and require detailed planning.

Prior to the start of the offloading copies of the certain essential documents must be obtained to keep track of the movement of products (*Figure 119*).



Figure 119: Essential documents to gather prior to monitor offloading

The detailed cargo manifest shows position of the products in the holds corresponding to the details for each donor vessels (*Figure 120*). The fish from different donor vessels are separated in the carrier vessels hold using cargo nets (*Figure 118*).



## Port State measures

### Procedures for the implementation of the Indian ocean Tuna Commission

must be made to record weights on a hook scale. Good communication with the crane driver will facilitate holding a hoist stationary for a few seconds to allow counts and reading the hook scale, before the fish are taken out-board to shore or the receiving vessel.

Where fish are being offloaded ashore a second monitoring position can be established, where the hoists are set down. This position may also provide opportunity to confirm species composition and take samples of units to get average weights.

#### ***Sampling procedures to determine average weight of the fish***

To determine the unit weights for the different species being offloaded, any one or a combination of the methods used for offloading from longline vessels may be appropriate. However, the most practical and accurate will be to use a hook scale attached to the crane hook and record the total weight of a hoist and divide this by the number of fish units in the hoist. Cooperation with the vessels personal to load a string with a single species only will also assist in improving accuracy.

The alternative method would be to use the declared weight and numbers and to calculate the average weight and apply this to the number of units on a string to get the weight of the hoist. This method is not an independent estimate of weights and relies on accurate unit counts to verify declared quantities being offloaded or transhipped.



© IOTC

*Figure 121: Offloading of string of tunas*

#### Box 49 | Calculation of unit trunk weight on a string using a hook scale

→ Record number of fish units,

→ Record total weight of the string from the hook scale.

*The average weight is equal to the total hook scale weight divided by the count of fish units on the string.*

*Example:*

*Number of units* = 34

*Hook scale reading* = 1649 kg

*Average unit weight* = 1649 / 34

= 48.50 kg

Various procedures for inspection and monitoring offloadings from carrier vessels are presented in [Table 33](#).

## Port State measures

### Procedures for the implementation of the Indian ocean Tuna Commission

*Table 33 - Procedures for inspection and monitoring offloading from carrier vessel*

Arrival on the carrier vessel	Introduction and briefing with master by the inspection team leader and presentation of inspectors' identifications and mandate.
Request for documentation	Inspectors monitoring offloading must: <ul style="list-style-type: none"> <li>→ confirm quantities to be offloaded as reported in the AREP;</li> <li>→ request cargo manifest and hold plan and dimension;</li> <li>→ request loading plan showing product location, quantities and species relative to each donor vessel.</li> </ul>
Request details of offloading plan and procedure	Request details of method and procedures that will be followed when offloading. Note sequence of holds to be offloaded, quantities and product origins.
Discuss planned sampling of catch for verifying weight and species composition	Discuss need for recording sample weights and species Determine where these can be undertaken to cause least disruption to offloading operations and effect on product quality. Confirm that a hook scale will be used.
Inspection of hold before offloading operation	Undertake an advanced inspection of hold and compartments where fish are stored to record to what capacity they are filled and take photographs.
Setup monitoring position(s)	Select a position where the fish being hoisted out of the hold can be observed; counted and species identified and the hook scale can be read. Consideration should be given to manning more than one position to observer offloading process. When selecting a position note health & safety requirements with respect to fish falling from hoists or collapse of the crane. (These often occur). Possible positions: <ul style="list-style-type: none"> <li>→ on the deck of the carrier being offloaded or transhipping, with full view of the hatch opening;</li> <li>→ in another position to allow opportunity to read hook scale.</li> </ul> Where one carrier is transhipping to another, a position on the receiving vessel can be set up with view of fish from the hold of the donor vessel to the receiving vessel.



<p>Sampling for average weight</p>	<p>At random intervals request a single or number of fish from a hoist to weigh.</p> <ul style="list-style-type: none"> <li>→ <i>Random number tables can be computer generated to facilitate these selections.</i></li> <li>→ Weight using a hanging or platform scale depending on what's available and the size of the fish may be practical in some circumstances.</li> <li>→ Request use of the hook scale for weighing samples of large fish.</li> </ul>
<p>Sampling for species composition</p>	<p>The products of several tuna species, (yellowfin and bigeye) are processed in the same manner and it may be difficult to identify between the species when together in a single hoist. These can be recorded as an aggregation for the different species.</p> <p><b><i>For example. YFT and BET mixed</i></b></p> <p>To determine the ratio of the two species selected hoist can be lowered to the deck and inspectors can sample for the different species from closer examination of the trunks.</p>
<p>Monitoring Hoists</p>	<p>Record the date / time of first hoist.</p> <p>Record for each hoist; the number of fish, species and product.</p> <p>Record hook scale weight (if attached).</p> <p>Number each hoist consecutively from the first to the last.</p> <p>Take photographs of hoists where species are not clearly identified.</p> <p>Record start and end time of interruptions in offloading or transhipment operations due to meal breaks or technical difficulties.</p> <p>Record the date / time of the last hoist.</p>
<p>End of offloading and transhipment operations</p>	<p>Summarise quantities recorded offloaded for:</p> <ul style="list-style-type: none"> <li>→ Each donor vessel, noting: <ul style="list-style-type: none"> <li>→ weight per species;</li> <li>→ processing code.</li> </ul> </li> </ul> <p>Request copy of the total offloading or transhipment declaration-forms.</p> <p>Compare the monitored quantities to that declared by the vessel and note difference.</p>

## Port State measures

### Procedures for the implementation of the Indian ocean Tuna Commission

<b>Hold inspection</b>	<p>Request a vessel officer to accompany inspector for an inspection of the carriers hold after transhipment operations.</p> <p>Note hold divisions.</p> <p>Record:</p> <ul style="list-style-type: none"><li>→ number, species and weight of fish remaining in the hold;</li><li>→ how estimates of remaining fish are determined:<ul style="list-style-type: none"><li>→ Visual count;</li><li>→ Fish weighed.</li></ul></li></ul> <p>Calculate volume of hold and compare to volume of remaining fish.</p> <p>Photograph empty hold or remaining fish in hold.</p> <p>Request a declaration from the vessel of the quantity of fish remaining in the hold.</p> <p>Record difference between recorded and declared quantities.</p>
<b>Reconciliation</b>	Complete inspection report fields 30 and 31.
<b>Debriefing with vessel master / fishing master</b>	Debrief responsible persons on board and provide copies of recorded quantities monitored, allowing their comments and signatures to be appended.

### 6.3.5. Sampling forms

Due to the variability and time taken to complete transhipments, detailed data recording forms are required to capture a variety of information during the task. The information recorded is then summed up to produce a collective summary of the quantities and species transhipped that can be used to verify the declared information provided in the AREP and transhipment declarations.

The detailed recording form must provide the freedom to record various levels of information allowing for variations in transhipment methods during a single operation.

Offloading forms are divided into four sections.

- generic vessel details
- detailed observation information
- statistical information on:
  - observed times;
  - species weights and product codes;
  - hoist information;
  - summary of total catch.

The two offloading monitoring forms are presented in Appendix XI.

## **6.4. Follow up procedures, actions and requirements, and information sharing**

The IOTC PS MR provides procedures, actions and other requirements following inspections that have taken place. These include:

- reporting the results of the inspections;
- port State actions following inspection where there are clear grounds to believe IUU fishing or related activities have occurred;
- information on recourse where loss or damage occurred as a consequence of alleged unlawful actions by the port State ; and
- flag State responsibilities for vessels where the inspection report indicates clear grounds to believe its vessel has engaged in IUU fishing or related activities.

### **6.4.1. Reporting the results of inspections**

Within three full working days of the completion of the inspection, the CPC is required to transmit a copy of the inspection report (which must include, as a minimum standard, all information set out in Annex III of the IOTC PS MR), and if requested, original or certified copies by electronic means, to the addressees in *Figure 122*.

## Port State measures

Procedures for the implementation of the Indian ocean Tuna Commission

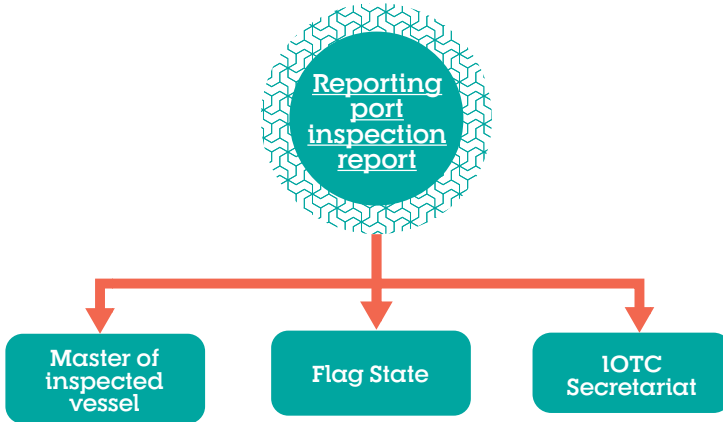

Source: IOTC, 2021

Figure 122: Inspecting CPC reporting requirements following inspections

If appropriate, copies should also be transmitted to the addressees in [Figure 123](#).

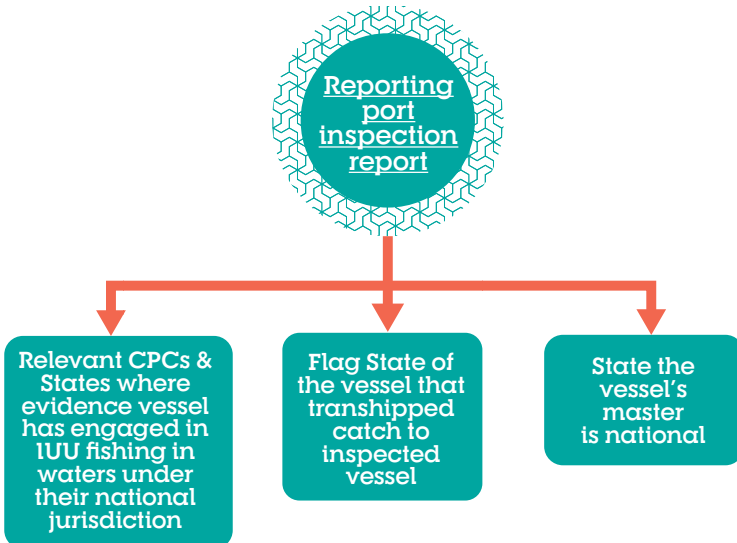

Source: IOTC, 2021

Figure 123: Reporting requirements following inspections

The IOTC Secretariat must without delay also transmit the inspection reports to the relevant RFMOs and post them on the IOTC website (*Figure 124*).

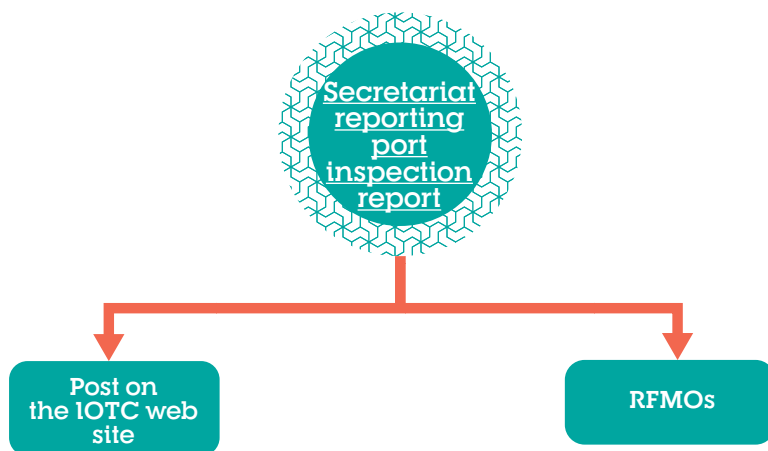

Source: IOTC, 2021

*Figure 124: Reporting requirements following an inspection*

## **6.4.2. Port State actions following inspections**

### ***Request to the flag State for confirmation that catch taken in compliance with RFMO requirements***

- The port State is mandated to communicate with the flag State of the vessel to confirm that the fish on board was taken in accordance with applicable requirements of a relevant RFMO - i.e. IOTC or any other organisation. As noted above in section 3.3.1, this may be done even before inspection; **the IOTC PSMR requires denial of port use after entry into port, with no preliminary inspection required, where the flag State does not provide confirmation of compliance within a reasonable time.**

## Port State measures

### Procedures for the implementation of the Indian ocean Tuna Commission

To facilitate this process, a specific form has been designed: "*Request to the flag State for confirmation that catch complies with RFMO requirements*" (Appendix X11). The form allows the port State to request information to the flag State on:

- flag State authorisation to fish;
- flag State authorisation to tranship;
- fishing logbook;
- certificate of registry of the fishing vessel;
- IOTC transhipment declarations (From transhipment operation with donors vessels);
- VMS record; and
- any other information/document relevant to the irregularities.

Following the request of the port State, the flag State must respond to the port State within the time period specified by the port State. The IOTC PSMR does not define a specific period of time, but requires the flag State to respond within a "*reasonable period of time*".

An international standard of 3 working days for the receipt of a response from the flag State is set in the UN Fish Stocks Agreement in similar circumstances, and this is recommended as a "reasonable period of time for port State measures. (The UNFSA provides that where, following a boarding and inspection, there are clear grounds for believing that the vessel has engaged in any activity contrary to RFMO CMMS, the inspecting State must secure evidence and notify the flag State of the alleged violation; the flag State has three working days to respond.).

If the flag State does not respond within the period of time specified in the form, the port State must deny use of port in accordance with paragraph 9.1 of the IOTC PSMR.

As a practical matter, where the information provided by the flag State does not appear to confirm compliance or appears to be false, incomplete or misleading, the port State should undertake further investigations to establish

clear grounds for believing that there was non-compliance with applicable RFMO requirements before denying use of port.

### ***Deny use of port and issue notifications***

Where, following an inspection, there are clear grounds for believing that a vessel has engaged IUU fishing or related activities (*Figure 125*), the inspecting CPC is required to issue specified notifications and deny the use of port to the vessel (Part 4, paragraph 15 of the IOTC PSMR).

This includes all inspections which took place, noting that the use of port may have already been denied without inspection under conditions specified in paragraph 9.1 of the PSMR as explained in sections 3.3.1(c) and 6.1.1 above.<sup>1</sup>

The port State must, in conformity with international law, deny the use of its ports for landing, transshipping, packaging, and processing of fish and for other port services including, inter alia, refuelling and resupplying, maintenance and dry-docking.

The exceptions to the above action are to allow the use of port services essential to the safety or health of the crew or the safety of the vessel or where appropriate, for the scrapping of the vessel.

When the results of the inspection provide clear evidence that a vessel has engaged in IUU fishing or fishing related activities in support of IUU fishing, the inspecting CPC must promptly notify its findings to:

---

**1** The conditions are:

- the vessel does not have a valid and applicable authorisation to engage in fishing or fishing related activities required by its flag State;
- the vessel does not have a valid and applicable authorisation to engage in fishing or fishing related activities required by a coastal State in respect of areas under the national jurisdiction of that State;
- clear evidence has been received that the fish on board was taken in contravention of applicable requirements of a coastal State in respect of areas under the national jurisdiction of that State;
- the flag State does not confirm within a reasonable period of time, on the request of the port State, that the fish on board was taken in accordance with applicable requirements of a relevant regional fisheries management organisation;
- there are reasonable grounds to believe that the vessel was otherwise engaged in IUU fishing or fishing related activities in support of such fishing, including in support of a vessel that has also been engaged in IUU fishing.



- the flag State;
- the IOTC Secretariat;

and as appropriate:

- relevant coastal States;
- relevant regional fisheries management organisations;
- the master's national State;
- there are reasonable grounds to believe that the vessel was otherwise engaged in IUU fishing or fishing related activities in support of such fishing, including in support of a vessel that has also been engaged in IUU fishing.

## Port State measures

Procedures for the implementation of the Indian ocean Tuna Commission

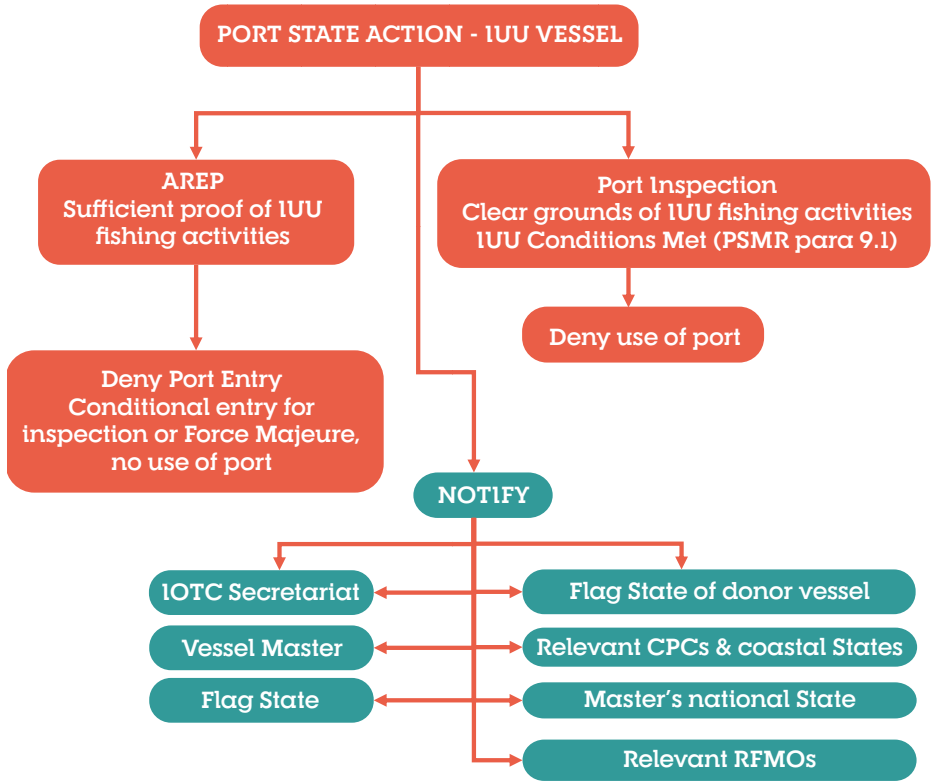

Source: IOTC, 2021

*Figure 125: Port State actions when evidence indicates IUU fishing or related activities*

The port State may deny the use of port to the vessel if not already done. National legislation may also provide that anyone who assists a vessel to use the port, where use has been denied, commits an offence.

In addition to denial of use of port, the IOTC PSMR recognises that the port State may take additional measures in conformity with international law. These may include initiation of legal or administrative proceedings against the vessel under national law and penalties expressly requested or consented to by the flag State of the vessel.

***Port State actions against the vessel: inspection, investigation, arrest, seizure and detention, bond and fine/penalty.***

Depending on the type and seriousness of the offence, the fines and penalties established in national legislation for the offence committed and the type of legal process selected (administrative, civil or criminal), the port State may wish to impose additional sanctions on the vessel, owner or master (these individuals are often defined as 'the operator' of the vessel in some fisheries legislation) or the agent.

The fines and penalties can range from the imposition of an administrative or court fine to the arrest of the offender(s), detention, seizure and forfeiture of the vessel and its gear, equipment and the catch, as well as other penalties provided in national legislation such as banning order prohibiting the Master or vessel from entering national waters for a specified period of time. Procedures for including the vessel on the IUU Vessel List may also be initiated. As described above, foreign vessels may be subject to a port inspection to verify their compliance with national legislation, and IOTC CMMs, CMMs of other relevant RFMOs, requirements of coastal States where the vessel has been carrying out fishing or related activities and applicable international laws and agreements. Possible non-compliance with flag State requirements may also be noted.

In this regard, port inspectors and managers should be aware of certain potential offences that may be in national legislation, including:

- violation of a CMM of a relevant RFMO (in which both port State and flag State are members);
- importing, trading, buying selling or exporting fish caught in contravention of the laws of another State;
- offences relating to IUU fishing and related activities.

If at any point during the inspection process the information provided or evidence collected indicate that IUU fishing or related activities 'may' have taken, or took place, the port inspection moves to an investigative and evidence gathering phase if this has not already been done (see Chapter 2, section 4.7).

## ***Investigation***

When the port inspection has moved to this stage, inspectors must be aware of this and be more meticulous in their work and carefully record their actions, the documents checked and evidence gathered, which may be used to prove the alleged infraction.

It is important to remember that the gathering of evidence is to support an 'alleged' offence. It is not yet proven, and consequently the master and crew must not be treated as offenders but as "*individuals under investigation*". During this phase the inspectors must check everything and ensure that authorities in higher positions have been informed and are in support of the investigation activities.

After initial analysis of the evidence and discussions with higher authorities and if necessary, prosecutors, a decision may then be made to detain the vessel and crew for further investigation. It is not necessary to arrest the master and crew at this point if they remain cooperative, but their passports and seaman's books are confiscated.

During the more intensive investigation phase, it is common practice to remove the crew from the vessel to the quayside under watch of inspectors while the investigation proceeds. This is to preserve any evidence on board and ensure it is not tampered with or destroyed during the investigation. If required, individual crew can be requested to accompany the investigators during this phase of the investigation.

Depending on the evidence collected and the severity of the alleged offence, further action may be warranted that will lead to the formal arrest procedures of the master and key crew members. Usually the remainder of the crew are processed by immigration authorities and released or returned to their home ports. The vessel, equipment, gear and catch on board would then typically be formally seized pending the judicial outcome of the case for alleged IUU fishing or related activities.

Strict procedures must be followed to secure the vessel, equipment, gear and catch. A common error often made at this point in time is the failure to make a full and detailed inventory of the vessel, equipment, gear and catch on board. It is strongly recommended that this inventory is done using both video and recorded notes for each cabin and the workspace of the vessel. In most cases, the perishable component of the catch is auctioned to reduce storage costs and is sold at as close as possible to market price. Revenues from this process are placed in a State account until the resolution of the case.

In the event the alleged offences are not proven in the legal or administrative system, the operators (owner, master, any legal or natural person in control) will be entitled to the return of the vessel, equipment, gear and catch. National legislation may provide that the vessel, equipment and gear:

- must be returned in the same conditions as when detained/seized;
- must be maintained at a reasonable standard; or
- that any person exercising lawful power under the Act is not liable for any spoilage or deterioration in the quality of any fish or other item seized, taken possession of or detained. The inspectors should know which of the above standards of care apply to the detained/seized items in their country.

If one of the first two standards are in national legislation and the items have been damaged or are missing, the port State may be liable for the damages. It is for this reason that very strict and careful procedures must be followed when the decision is made to seize the vessel and all equipment, gear and catch.

## ***Arrest***

If the national legislation permits it and depending on the circumstances, a fisheries inspector may arrest the person on reasonable grounds that an offence has been committed. Before making an arrest, the fisheries inspector (or other person with authority to arrest) must take into consideration that an arrest is not a punishment, and therefore, should not be more aggressive or oppressive than is necessary. The power of arrest must be exercised with caution because the fisheries authority can be held liable for acts of its fishery inspector which are outside the scope of the inspector's authority. It is important to ensure that all of the elements necessary for an arrest are established before taking such action against the alleged offender.

It is recommended to strictly observe the basic procedures for arrest of an offender:

the fishery inspector must identify himself as a fisheries inspector, clearly state to the suspected offender under which section(s) of the national legislation he or she is being charged and ensure the suspected offender understands the specific charge.

If there is cooperation, the inspector can take possession of the passport and seaman's book (if empowered in legislation) of the individual being charged. Use of force is not required, including the use of handcuffs. National legislation and procedures should provide guidelines for the use of force, which usually should be proportionate to the situation and need. The alleged offender should be taken to be formally charged and can be detained under 'house arrest' arranged by the vessel agent at their cost and with the guarantee of their appearance as required in the case.

If the need arises to interrogate the offender, he or she should be advised of their rights prior to questioning. Before interrogation, to preserve the admissibility of the statement against the offender in proceeding, the fishery inspector must warn the offender he or she has the right to remain silent; anything he or she says can be used as evidence against him or her; he or she has the right to have an attorney present before and during the questioning and has the right, if he or she can't afford an attorney, to have an attorney appointed

at public expense to represent him or her before and during the questioning. There must always be at least two port inspectors present during any interrogation process.

The main reasons to place a person under arrest after it has been determined that an offence has been committed are to secure or preserve evidence of/ or relating to the offence, and, prevent the continuation or repetition of the offence or the commission of another (e.g. assault).

### ***Seizure and detention***

In case of a seized vessel, the custody may remain with the fisheries authority, or some other designated security authority, which will be responsible for maintaining security and a permanent (24/7) watch on the seized vessel. No person shall be allowed to board the seized vessel, except officials from the port State or the vessel's agent or legal representative. Two fisheries inspectors shall be placed on board the seized vessel to ensure that no one leaves or boards the vessel unless authorised in writing and to monitor their activities while on board.

In case of seizure of catch, gear or other equipment, they shall be tagged with a government seal. The seized items become the responsibility of the fisheries authority and every action must be taken to safeguard them. The custody of the items seized can be assured by off-loading all seized goods and storing them as may be provided in national legislation; for example, it could be stored under the name of the fisheries authority at a secured commercial warehouse or on fisheries authority property.

In the case of seizure of perishable items, the national legislation normally provides a procedure. It is common practice for the court to order that they may be sold on auction at a price nearest or above current price. The revenues from the sale must then be placed in an escrow account, with interest, until the final resolution of the case. Depending on the outcome of the case, the seized goods and the funds in the escrow account may be forfeited to the port State or returned to the accused, but in the interim, their security remains that of the port State.

### ***Bonds and other financial assurances***

The national fisheries or other applicable legislation should be checked for requirements to release a seized vessel and its crew on bond or other financial assurances. The bond will be forfeit if the vessel does not meet conditions related to a subsequent determination of its participation in IUU fishing activities. National legislation should also be checked for:

- any maximum period for seized or detained items or persons;
- requirements for release of items, for example whether, upon release of a vessel any illegal items such as gear and catch (including funds from sale held in escrow) can be retained.

UNCLOS Article 73(2) (*Enforcement of laws and regulations of the coastal State*) requires foreign vessels and their crews that are **arrested for fisheries offences in the EEZ** to be promptly released upon the posting of reasonable bond or other security. The International Tribunal for the Law of the Sea has authority to hear cases where a reasonable bond or other security has not been set (Article 292) and several cases have been brought for prompt release where this has not been done. The Tribunal has usually taken a very strict view of this requirement and ordered prompt release.

However, if a vessel or its crew have not been arrested for offences in the EEZ it would not fall within this provision.

There can be risks in "*prompt release*" upon the posting of a reasonable bond or other security if not handled properly; after posting a bond, vessels do not always return for final proceedings or the funds are not received by the port State. The amount and process for payment of the bond are crucial, and reasonable time must be taken to ensure both serve the purpose intended by UNCLOS. In the meantime, vessels should be immobilised so they cannot illegally depart from port.

The experience of some developing CPCs illustrates the risks involved.



In one case, following good negotiations and agreement for the release of a vessel and crew by the port State in good faith, a bond in the form of a Bank Guarantee was received. But immediately on release of the vessel the agreement was refuted, the Bank Guarantee was not honoured and the charges were then challenged by the alleged violator.

The developing port State then had little leverage on the alleged violator, except to propose listing on the IUU Vessel List and seek regional cooperation to detain the vessel and bring it back to the port State for proceedings.

In another case, concerning a longline vessel, the bond was received but the outstanding fine of USD 4.5 million was not paid.

The calculation of the value of a bond or Bank Guarantee may be detailed within your national legislation governing fisheries or relevant judicial/administrative proceedings and should be handled by relevant officials in your administration and/or the Attorney General's office. Criteria for the seriousness of the violation (noted in the next section under "Fines and penalties") should be considered, and the maximum value of the applicable fine(s), the vessel, equipment, gear and catch should be estimated and applied as a non-negotiable condition. Valuation of vessel and catch is generally undertaken by an expert, and an overview of current market price for the main commercial species is recommended.

Terms of payment of the bond and release of the vessel and crew must be ironclad. Some elements could include guarantee of payment by the embassy of the flag State, designating a national bank for the receipt of the payment, national bank confirmation by the national bank that funds have been received and that they are locked in unless approved by a court or other designated authority. withdrawal can only take place upon the approval of the receiving bank that the funds have been transferred to the bank.

What is important, and noted once again, is that the vessel is kept safely and securely; the vessel and everything on it remains in port unaltered and consistent with a standard that may be provided in national legislation. If the

## Port State measures

### Procedures for the implementation of the Indian ocean Tuna Commission

catch has been removed it must be prevented from spoiling, as discussed earlier, or auctioned with the proceeds kept in escrow.

Remember that a full load of a tuna purse seiner (for the canning industry) or a longliner (sashimi grade tuna) can be worth millions of dollars and the vessel owners will lose claim to this permanently only if found guilty.

During the proceedings described above, involving decisions on seizure, detention, arrest and release on bond, managers and inspectors should be aware that IOTC Resolution 07/01 promotes compliance by nationals of CPCs with CMMs.

The flag State must be reminded of its responsibilities under that Resolution, which include maintaining effective control over its nationals. The term "nationals" includes flag vessels and persons, and "persons" includes both natural persons (individuals) and legal persons (companies, associations etc). Flag State responsibilities include maintaining effective control over their nationals.

The Resolution aims to enhance cooperation among CPCs through facilitating measure being taken against natural or legal persons subject to their jurisdiction that have engaged in IUU fishing or related activities. It expresses concern about participation by such persons in activities contravening CMMs, such as transshipment, transport and trade of illegally harvested catches or engagement on board or in the management of these vessels. CPCs are also encouraged to seek the cooperation of industries within their jurisdiction.

The Resolution calls on CPCs to investigate allegations and/or reports of persons subject to their jurisdiction engaging in IUU fishing or related activities, and to take actions in response to any verified activities.

## ***Fines and penalties***

Fines and penalties that courts or administrative processes may impose for the offence are set out in national legislation. They may be imposed on the operators (usually defined as including *"any person who is in charge of, responsible for the operations of, directs or controls a vessel, including the owner, charterer, master and the beneficiary of the economic or financial benefit of the vessel's operations"*), as appropriate an agent but not usually crew members.

The legislation may contain guidelines for determining the value of the fine and setting a penalty. Criteria may include the:

- seriousness of the offence;
- value of the vessel and fishing gear;
- value of the catch on board;
- value of the illegal catch taken if it can be calculated;
- frequency of violation;
- impact on the environment;
- cooperation of the offender.

Some national legislation provides that *"if the illegal catch taken cannot be calculated, all the catch on board is assumed to be illegal catch"*.

Penalties could range from forfeiture of the vessel, equipment, gear, catch etc to banning orders for the vessel/master, double the maximum fines for bodies corporate, revocation of the vessel's licence and imposition of separate fines for each day the offence was committed.

As noted above, concerning release and imprisonment of foreign nationals, UNCLOS Article 73 UNCLOS (*"Enforcement of laws and regulations of the coastal State"*) requires arrested vessels and their crews arrested in the EEZ to be promptly released upon the posting of reasonable bond or other security, and prohibits imprisonment of foreigners for violations of fisheries legislation in the absence of agreements to the contrary by the States concerned.

It is recommended that port State CPCs develop a schedule of criteria for assessing appropriate fines and penalties to be used as a guide by the prosecuting authority. Fisheries and legal authorities should cooperate in this endeavour. The purpose of such criteria is to achieve consistent, fair fines and penalties that are not dependent on which prosecutor happens to be assigned the case or in what part of the country the violations occurred.

However, it should be understood that the judiciary must always maintain its absolute discretion in deciding on the fine/penalty. In this context, it could be useful to raise the awareness of the judiciary concerning the practical consequences of IUU fishing and the international standards and best practices in determining fines and penalties. Regional or other awareness-building initiatives could be developed towards this end.

### ***Request listing on IOTC IUU Vessel List***

Under resolution 18/03 *On Establishing A List Of Vessels Presumed To Have Carried Out Illegal, Unregulated And Unreported Fishing In The IOTC Area*, the port State CPC can request the listing of a vessel on the IOTC IUU Vessel List. The reporting process involves the use of the IOTC reporting form for illegal activity (Annex 1 of Resolution 18/03) accompanied by evidence supporting the presumption of IUU fishing activity.

The reporting form contains four sections, described below.

- Section A requires information on the details of the vessel and the incidents of illegal activity, and the outcome of actions taken must be described.
- Section B requires information on each individual element of IOTC Resolution 18/03 that were contravened. Relevant details are required including the date, location and source of information. Extra information can be provided in an attachment if necessary.
- Section C requires a listing of any associated documents that are appended (e.g. port inspection report, vessel document, court proceedings, photographs).
- Section D provides a choice of three recommended actions:
  - notification to IOTC Secretariat only, no further action is recom-

mended;

- notification of illegal activity to IOTC Secretariat, recommend notification of activity to flag State;
- recommended for inclusion on IOTC IUU Vessel List.

Note: the IOTC reporting form for illegal activity can be downloaded from the IOTC web site ([www.iotc.org](http://www.iotc.org)) or requested by email to the IOTC Secretariat at [iotc-secretariat@fao.org](mailto:iotc-secretariat@fao.org).

### ***Information on recourse in the port State***

The port State CPC must give information to the flag State CPC to any recourse established under its national legislation concerning measures it has taken pursuant to paragraphs 7, 9, 11 or 15 of the IOTC PSMR, which relate to:

- port entry, authorisation or denial;
- use of ports;
- conduct of inspections; or
- port State actions following inspection.

The information must describe public services or judicial institutions available for recourse and indicate whether there is a right to seek compensation under national legislation in the event of any loss or damage suffered as a consequence of any alleged unlawful action by the CPC port State.

The CPC must maintain the relevant information available to the public and provide such information, upon written request, to the owner, operator, master or a representative of a vessel. The CPC must inform the flag State, the owner, operator, master or representative, as appropriate, of the outcome of any such recourse action. Where other Parties, States or international organisations have been informed of prior decision concerning the four paragraphs described above, the CPC must inform them of any changes in decision.

### **6.4.3. Flag State role and responsibilities**

The IOTC PSMR describes the role and responsibilities of CPC flag States in the context of port State measures when its vessels are seeking entry into or are in foreign ports. The role of the flag State was introduced in section 3.3.2.

**Follow up to port State inspection** Where a flag State CPC receives an inspection report indicating that there are clear grounds to believe that its flag vessel has engaged in IUU fishing or related activities, it must immediately and fully investigate the matter and shall, upon sufficient evidence, take enforcement action without delay in accordance with its legislation.

Flag State actions could include withdrawal of authorisation and de-listing from the IOTC Record of Authorised Vessels.

Furthermore, in its capacity as flag State, an IOTC CPC must report on the actions it has taken in respect of its flag vessels that were determined to have engaged in IUU fishing activities as a result of port State inspection. Reports must be made to other CPCs, relevant port States and as appropriate relevant States, RFMOs and FAO.

**Cooperation with port States.** CPC flag States must require its flag vessels to cooperate with the port State in inspections carried out pursuant to the IOTC PSMR.

**Request port State to inspect, take measures.** When a flag State CPC has clear grounds to believe that a flag vessel has engaged in IUU fishing or related activities and is seeking entry to or is in the port of another State, it must, as appropriate, request that State to inspect the vessel or to take other measures consistent with the IOTC PSMR.

**Encourage flag vessels to use ports of compliance.** Flag State CPCs must encourage its flag vessels to land, tranship, package and process fish, and use other port services, in ports of States that are acting in accordance or consistently with the IOTC PSMR. CPCs are encouraged to develop fair, transparent

and non-discriminatory procedures for identifying any State that may not be acting in accordance or consistently with the Resolution.

#### **6.4.4. Duties of the IOTC Secretariat**

The IOTC Secretariat has duties to post certain information on its website including, on a secure part of the website, copies of all port inspection reports transmitted by port State CPCs. In addition, it must post:

- the list of designated ports;
- the prior notification period established by each CPC;
- the information about the designated competent authority in each port State CPC;
- the blank copy of the IOTC Port Inspection report form. All forms related to a specific landing or transshipment will be posted together, and the Secretariat will transmit inspection reports to relevant regional fisheries management organisations.

### **6.5. Information systems on port State measures**

An essential component in the IOTC PSMR is the electronic availability and exchange of information among CPCs that supports implementation and compliance. This information must cover all activities falling within the Resolution, including fishing, related activities, reporting, inspections and others.

The FAO PSMA established a system for the electronic exchange of information (Article 16) and requires parties, where possible, to establish a communication mechanism that allows for direct electronic exchange of information, with due regard to appropriate confidentiality requirements. Information is to be transmitted through a mechanism consistent with Annex D of the PSMA (Annex IV of the IOTC PSMR).

The original aim in including the provision in the FAO PSMA was to provide a basis for an international communication mechanism that may be developed in future. The CPCs are required, under Annex IV, to:

- Standard Operating Procedures - on board inspection of vessel –

## Port State measures

### Procedures for the implementation of the Indian ocean Tuna Commission

- seek to establish a computerized communication;
- establish, to the extent possible, websites to publicize the list of its ports designated in accordance with point 5.1 and the actions taken in accordance with the relevant provisions of the PSMR;
- identify, to the greatest extent possible, each inspection report by a unique reference number starting with the 3-alpha code of the port State and identification of the issuing agency;
- utilize, to the extent possible, the international coding system below in the advanced request to enter port and the results of the inspection of a vessel that has been granted permission to enter port and translate any other coding system into the international system.

The international coding system should include the following (see also Appendix X111):

- countries/territories: ISO-3166 3-alpha Country Code;
- species: ASFIS 3-alpha code (known as FAO 3-alpha code);
- vessel types: ISSCFV code (known as FAO alpha code);
- gear types: ISSCFG code (known as FAO alpha code).

The IOTC e-PSM application, described in section 3.3.5, adopts these requirements and includes information on: an overview of the e-PSM process, the vessel file listing, risk assessment report, AREP process, port inspection process, transshipment monitoring process, sharing a vessel file and the vessel file status. There are also detailed descriptions of all fields used in the AREP process and the port inspection process.



# 7

## Appendices



## **APPENDIX I:**

# IOTC Resolution 16/11 on Port State Measures to Prevent, Deter and Eliminate Illegal, Unreported and Unregulated Fishing

### **The Indian Ocean Tuna Commission (IOTC),**

DEEPLY CONCERNED about the continuation of illegal, unreported and unregulated fishing in the IOTC Area and its detrimental effect upon fish stocks, marine ecosystems and the livelihoods of legitimate fishers in particular in Small Island Developing States, and the increasing need for food security in the region,

CONSCIOUS of the role of the port State in the adoption of effective measures to promote the sustainable use and the long-term conservation of living marine resources,

RECOGNIZING that measures to combat illegal, unreported and unregulated fishing should build on the primary responsibility of flag States and use all available jurisdiction in accordance with international law, including port State measures, coastal State measures, market related measures and measures to ensure that nationals do not support or engage in illegal, unreported and unregulated fishing,

RECOGNIZING that port State measures provide a powerful and cost-effective means of preventing, deterring and eliminating illegal, unreported and unregulated fishing,

## Port State measures

### Procedures for the implementation of the Indian ocean Tuna Commission

AWARE of the need for increasing coordination at the regional and interregional levels to combat illegal, unreported and unregulated fishing through port State measures,

RECOGNIZING the need for assistance to developing countries, in particular Small Island Developing States to adopt and implement port State measures,

TAKING NOTE OF the binding Agreement on port State measures to combat IUU fishing which was adopted and opened for signature within the framework of FAO in November 2009, and desiring to implement this Agreement in an efficient manner in the IOTC Area,

BEARING IN MIND that, in the exercise of their sovereignty over ports located in their territory, IOTC Members and Cooperating non-Contracting Parties (CPCs) may adopt more stringent measures, in accordance with international law,

RECALLING the relevant provisions of the United Nations Convention on the Law of the Sea of 10 December 1982, hereinafter referred to as the Convention,

RECALLING the Agreement for the Implementation of the Provisions of the United Nations Convention on the Law of the Sea of 10 December 1982 relating to the Conservation and Management of Straddling Fish Stocks and Highly Migratory Fish Stocks of 4 December 1995, the Agreement to Promote Compliance with International Conservation and Management Resolutions by Fishing Vessels on the High Seas of 24 November 1993 and the 1995 FAO Code of Conduct for Responsible Fisheries,

ADOPTS, in accordance with the provisions of Article IX, paragraph 1 of the IOTC Agreement, the following:

**PART I****GENERAL PROVISIONS****1. Use of terms**

For the purposes of this Resolution:

- a. "*fish*" means all species of highly migratory fish stocks covered by the IOTC Agreement;
- b. "*fishing*" means searching for, attracting, locating, catching, taking or harvesting fish or any activity which can reasonably be expected to result in the attracting, locating, catching, taking or harvesting of fish;
- c. "*fishing related activities*" means any operation in support of, or in preparation for, fishing, including the landing, packaging, processing, transshipping or transporting of fish that have not been previously landed at a port, as well as the provisioning of personnel, fuel, gear and other supplies at sea;
- d. "*illegal, unreported and unregulated fishing*" refers to the activities set out in paragraph 1 of the Resolution 2009/03;
- e. "*port*" includes offshore terminals and other installations for landing, transshipping, packaging, processing, refuelling or resupplying; and
- f. "*vessel*" means any vessel, ship of another type or boat used for, equipped to be used for, or intended to be used for, fishing or fishing related activities.

**2. Objective**

The objective of this Resolution is to prevent, deter and eliminate IUU fishing through the implementation of effective port State measures to control the harvest of fish caught in the IOTC Area, and thereby to ensure the long-term conservation and sustainable use of these resources and marine ecosystems.

**3. Application**

**3.1** Each CPC shall, in its capacity as a port State, apply this Resolution in respect of vessels not entitled to fly its flag that are seeking entry to its ports or are in one of its ports, except for:

## Port State measures

### Procedures for the implementation of the Indian ocean Tuna Commission

- a. vessels of a neighbouring State that are engaged in artisanal fishing for subsistence, provided that the port State and the flag State cooperate to ensure that such vessels do not engage in IUU fishing or fishing related activities in support of such fishing; and
- b. container vessels that are not carrying fish or, if carrying fish, only fish that have been previously landed, provided that there are no clear grounds for suspecting that such vessels have engaged in fishing related activities in support of IUU fishing.

**3.2** This Resolution shall be applied in a fair, transparent and non-discriminatory manner, consistent with international law

**3.3** Each CPC may utilise the e-PSM system, available via the IOTC website, to implement this Resolution. A trial period of three years from 2016 will be provided to allow for the delivery of a complete training programme and further improvement and development. CPCs shall encourage all stakeholders (vessel representatives, port States and flag States) to utilise, to the greatest extent possible, the e-PSM application to comply with this Resolution and provide feedback and inputs contributing to its development until 1 January 2020. At the sixteenth session of the Compliance Committee the success of this application shall be evaluated and consideration shall be given to making the use of this application mandatory and defining a period for implementation. After this date the possibility to submit an advance request for port entry manually in accordance with Article 6 will remain, should access to the Internet not be possible for any reason..

#### **4. Integration and coordination at the national level**

Each CPC shall, to the greatest extent possible:

- a. integrate or coordinate fisheries related port State measures with the broader system of port State controls;
- b. integrate port State measures with other measures to prevent, deter and eliminate IUU fishing and fishing related activities in support of such fishing, taking into account as appropriate the 2001 FAO International Plan of Action to Prevent, Deter and Eliminate Illegal, Unreported and Unregulated Fishing; and
- c. take measures to exchange information among relevant national agencies and to coordinate the activities of such agencies in the implementation of this Conservation and Management Resolution.

**PART 2****ENTRY INTO PORT****5. Designation of ports**

**5.1** Each CPC shall designate and publicize the ports to which vessels may request entry pursuant to this Resolution. Each CPC shall provide a list of its designated ports to IOTC Secretariat before 31 December 2010, which shall give it due publicity on the IOTC website.

**5.2** Each CPC shall, to the greatest extent possible, ensure that every port designated and publicized in accordance with point 5.1 has sufficient capacity to conduct inspections pursuant to this Resolution.

**6. Advance request for port entry**

**6.1** Each CPC shall require the information requested in Annex 1 to be provided before granting entry to a vessel to its port.

**6.2** Each CPC shall require the information referred to in point 6.1 to be provided at least 24 hours before entering into port or immediately after the end of the fishing operations, if the time distance to the port is less than 24 hours. For the latter, the port State must have enough time to examine the above mentioned information.

**7. Port entry, authorisation or denial**

**7.1** After receiving the relevant information required pursuant to section 6, as well as such other information as it may require to determine whether the vessel requesting entry into its port has engaged in IUU fishing or fishing related activities in support of such fishing, each CPC shall decide whether to authorize or deny the entry of the vessel into its port and shall communicate this decision to the vessel or to its representative.

**7.2** In the case of authorisation of entry, the master of the vessel or the vessel's representative shall be required to present the authorisation for entry to the competent authorities of the CPC upon the vessel's arrival at port.

**7.3** In the case of denial of entry, each CPC shall communicate its decision taken pursuant to point 7.1, to the flag State of the vessel and, as appropriate and to the extent possible, relevant coastal States and IOTC Secretariat. The IOTC Secretariat may, if deemed appropriate to combat IUU fishing at global level, communicate this decision to Secretariats of

other RFMO's.

**7.4** Without prejudice to point 7.1, when a CPC has sufficient proof that a vessel seeking entry into its port has engaged in IUU fishing or fishing related activities in support of such fishing, in particular the inclusion of a vessel on a list of vessels having engaged in such fishing or fishing related activities adopted by a regional fisheries management organisation in accordance with the rules and procedures of such organisation and in conformity with international law, the CPC shall deny that vessel entry into its ports.

**7.5** Notwithstanding points 7.3 and 7.4, a CPC may allow entry into its ports of a vessel referred to in those points exclusively for the purpose of inspecting it and taking other appropriate actions in conformity with international law which are at least as effective as denial of port entry in preventing, deterring and eliminating IUU fishing and fishing related activities in support of such fishing.

**7.6** Where a vessel referred to in points 7.4 or 7.5 is in port for any reason, a CPC shall deny such vessel the use of its ports for landing, transshipping, packaging, and processing of fish and for other port services including, inter alia, refuelling and resupplying, maintenance and drydocking. Points 9.2 and 9.3 of section 9 apply mutatis mutandis in such cases. Denial of such use of ports shall be in conformity with international law.

## **8. Force majeure or distress**

Nothing in this Resolution affects the entry of vessels to port in accordance with international law for reasons of force majeure or distress, or prevents a port State from permitting entry into port to a vessel exclusively for the purpose of rendering assistance to persons, ships or aircraft in danger or distress.

## **PART 3**

### **USE OF PORTS**

## **9. Use of ports**

**9.1** Where a vessel has entered one of its ports, a CPC shall deny, pursuant to its laws and regulations and consistent with international law, including this Conservation and management resolution, that vessel the use of the port for landing, transshipping, packaging and processing of



fish that have not been previously landed and for other port services, including, inter alia, refuelling and resupplying, maintenance and dry-docking, if:

- a. the CPC finds that the vessel does not have a valid and applicable authorisation to engage in fishing or fishing related activities required by its flag State;
- b. the CPC finds that the vessel does not have a valid and applicable authorisation to engage in fishing or fishing related activities required by a coastal State in respect of areas under the national jurisdiction of that State;
- c. the CPC receives clear evidence that the fish on board was taken in contravention of applicable requirements of a coastal State in respect of areas under the national jurisdiction of that State;
- d. the flag State does not confirm within a reasonable period of time, on the request of the port State, that the fish on board was taken in accordance with applicable requirements of a relevant regional fisheries management organisation; or
- e. the CPC has reasonable grounds to believe that the vessel was otherwise engaged in IUU fishing or fishing related activities in support of such fishing, including in support of a vessel referred to in point 7.4, unless the vessel can establish:
  - I. that it was acting in a manner consistent with relevant IOTC resolutions; or
  - II. in the case of provision of personnel, fuel, gear and other supplies at sea, that the vessel that was provisioned was not, at the time of provisioning, a vessel referred to in point 4 of paragraph 7.

**9.2** Notwithstanding point 9.1, a CPC shall not deny a vessel referred to in that point the use of port services:

- a. essential to the safety or health of the crew or the safety of the vessel, provided these needs are duly proven, or
- b. where appropriate, for the scrapping of the vessel.

**9.3** Where a CPC has denied the use of its port in accordance with this paragraph, it shall promptly notify the flag State and, as appropriate, relevant coastal States, IOTC or other regional fisheries management organisations and other relevant international organisations of its decision.

**9.4** A CPC shall withdraw its denial of the use of its port pursuant to point

9.1 in respect of a vessel only if there is sufficient proof that the grounds on which use was denied were inadequate or erroneous or that such grounds no longer apply.

**9.5** Where a CPC has withdrawn its denial pursuant to point 9.4, it shall promptly notify those to whom a notification was issued pursuant to point 9.3.

## **PART 4**

### **INSPECTIONS AND FOLLOW-UP ACTIONS**

#### **10. Levels and priorities for inspection**

**10.1** Each CPC shall carry out inspections of at least 5 percent of landings or transshipments in its ports during each reporting year.

**10.2** Inspections shall involve the monitoring of the entire discharge or transshipment and include a cross-check between the quantities by species recorded in the prior notice of landing and the quantities by species landed or transhipped. When the landing or transshipment is completed, the inspector shall verify and note the quantities by species of fish remaining on board.

**10.3** National inspectors shall make all possible efforts to avoid unduly delaying a vessel and ensure that the vessel suffers the minimum interference and inconvenience and that degradation of the quality of the fish is avoided.

**10.4** The port CPC may invite inspectors of other CPC to accompany their own inspectors and observe the inspection of landings or transshipment operations of fishery resources caught by fishing vessels flying the flag of another CPC.

#### **11. Conduct of inspections**

**11.1** Each CPC shall ensure that its inspectors carry out the functions set forth in Annex 2 as a minimum standard.

**11.2** Each CPC shall, in carrying out inspections in its ports:

- a.** ensure that inspections are carried out by properly qualified inspectors authorised for that purpose, having regard in particular to section 14;

- b. ensure that, prior to an inspection, inspectors are required to present to the master of the vessel an appropriate document identifying the inspectors as such;
- c. ensure that inspectors examine all relevant areas of the vessel, the fish on board, the nets and any other gear, equipment, and any document or record on board that is relevant to verifying compliance with relevant conservation and management resolutions;
- d. require the master of the vessel to give inspectors all necessary assistance and information, and to present relevant material and documents as may be required, or certified copies thereof;
- e. in case of appropriate arrangements with the flag State of the vessel, invite the flag State to participate in the inspection;
- f. make all possible efforts to avoid unduly delaying the vessel to minimize interference and inconvenience, including any unnecessary presence of inspectors on board, and to avoid action that would adversely affect the quality of the fish on board;
- g. make all possible efforts to facilitate communication with the master or senior crew members of the vessel, including where possible and where needed that the inspector is accompanied by an interpreter;
- h. ensure that inspections are conducted in a fair, transparent and non-discriminatory manner and would not constitute harassment of any vessel; and
- i. not interfere with the master's ability, in conformity with international law, to communicate with the authorities of the flag State.

## 12. Results of inspections

Each CPC shall, as a minimum standard, include the information set out in Annex 3 in the written report of the results of each inspection.

## 13. Transmittal of inspection results

**13.1** The port State CPC shall, within three full working days of the completion of the inspection, transmit by electronic means a copy of the inspection report and, upon request, an original or a certified copy thereof, to the master of the inspected vessel, to the flag State, to the IOTC Secretariat and, as appropriate, to:

- a. the flag State of any vessel that transhipped catch to the inspected vessel;

## Port State measures

### Procedures for the implementation of the Indian ocean Tuna Commission

- b. the relevant CPCs and States, including those States for which there is evidence through inspection that the vessel has engaged in IUU fishing, or fishing related activities in support of such fishing, within waters under their national jurisdiction; and
- c. the State of which the vessel's master is a national.

**13.2** The IOTC Secretariat shall without delay transmit the inspection reports to the relevant regional fisheries management organisations, and post the inspection report on the IOTC website.

#### 14. Training of inspectors

Each CPC shall ensure that its inspectors are properly trained taking into account the guidelines for the training of inspectors in Annex 5. CPC shall seek to cooperate in this regard.

#### 15. Port State actions following inspection

**15.1** Where, following an inspection, there are clear grounds for believing that a vessel has engaged IUU fishing or fishing related activities in support of such fishing, the inspecting CPC shall:

- a. promptly notify the flag State, the IOTC Secretariat and, as appropriate, relevant coastal States, and other regional fisheries management organisations, and the State of which the vessel's master is a national of its findings; and
- b. deny the vessel the use of its port for landing, transshipping, packaging and processing of fish that have not been previously landed and for other port services, including, inter alia, refuelling and resupplying, maintenance and drydocking, if these actions have not already been taken in respect of the vessel, in a manner consistent with this Conservation and Management Resolution.

**15.2** Notwithstanding point 15.1, a CPC shall not deny a vessel referred to in that point the use of port services essential for the safety or health of the crew or the safety of the vessel.

**15.3** Nothing in this Resolution prevents a CPC from taking measures that are in conformity with international law in addition to those specified in points 15.1 and 15.2, including such measures as the flag State of the vessel has expressly requested or to which it has consented.

## 16. Information on recourse in the port State

**16.1** A CPC shall maintain the relevant information available to the public and provide such information, upon written request, to the owner, operator, master or representative of a vessel with regard to any recourse established in accordance with its national laws and regulations concerning port State measures taken by that CPC pursuant to sections 7, 9, 11 or 15, including information pertaining to the public services or judicial institutions available for this purpose, as well as information on whether there is any right to seek compensation in accordance with its national laws and regulations in the event of any loss or damage suffered as a consequence of any alleged unlawful action by the CPC.

**16.2** The CPC shall inform the flag State, the owner, operator, master or representative, as appropriate, of the outcome of any such recourse. Where other Parties, States or international organisations have been informed of the prior decision pursuant to sections 7, 9, 11 or 15, the CPC shall inform them of any change in its decision.

## PART 5

### ROLE OF FLAG STATES

## 17. Role of CPCs flag States

**17.1** Each CPCs shall require the vessels entitled to fly its flag to cooperate with the port State in inspections carried out pursuant to this Resolution.

**17.2** When a CPC has clear grounds to believe that a vessel entitled to fly its flag has engaged in IUU fishing or fishing related activities in support of such fishing and is seeking entry to or is in the port of another State, it shall, as appropriate, request that State to inspect the vessel or to take other measures consistent with this Resolution.

**17.3** Each CPC shall encourage vessels entitled to fly its flag to land, tranship, package and process fish, and use other port services, in ports of States that are acting in accordance with, or in a manner consistent with this Resolution. CPCs are encouraged to develop fair, transparent and non-discriminatory procedures for identifying any State that may not be acting in accordance with, or in a manner consistent with, this Resolution.

**17.4** Where, following port State inspection, a flag State CPC receives an inspection report indicating that there are clear grounds to believe that

a vessel entitled to fly its flag has engaged in IUU fishing or fishing related activities in support of such fishing, it shall immediately and fully investigate the matter and shall, upon sufficient evidence, take enforcement action without delay in accordance with its laws and regulations.

**17.5** Each CPC shall, in its capacity as a flag State, report to other CPCs, relevant port States and, as appropriate, other relevant States, regional fisheries management organisations and FAO on actions it has taken in respect of vessels entitled to fly its flag that, as a result of port State measures taken pursuant to this Resolution, have been determined to have engaged in IUU fishing or fishing related activities in support of such fishing.

**17.6** Each CPC shall ensure that measures applied to vessels entitled to fly its flag are at least as effective in preventing, deterring, and eliminating IUU fishing and fishing related activities in support of such fishing as measures applied to vessels referred to in point 3.1.

## **PART 6**

### **REQUIREMENTS OF DEVELOPING STATES**

#### **18. Requirements of developing States**

**18.1** CPCs shall give full recognition to the special requirements of CPCs developing States in relation to the implementation of this Resolution. To this end, IOTC should provide assistance to CPCs developing States in order to, inter alia:

- a.** enhance their ability, in particular the least-developed among them and small island developing States, to develop a legal basis and capacity for the implementation of effective port State measures;
- b.** facilitate their participation in any international organisations that promote the effective development and implementation of port State measures; and
- c.** facilitate technical assistance to strengthen the development and implementation of port State measures by them, in coordination with relevant international mechanisms.

**18.2** IOTC shall give due regard to the special requirements of developing CPCs port States, in particular the least-developed among them and small island developing States, to ensure that a disproportionate burden resulting from the implementation of this Resolution is not transferred di-

rectly or indirectly to them. In cases where the transfer of a disproportionate burden has been demonstrated, CPCs shall cooperate to facilitate the implementation by the relevant CPCs developing States of specific obligations under this Resolution.

**18.3** IOTC shall assess the special requirements of CPCs developing States concerning the implementation of this Resolution.

**18.4** IOTC CPCs shall cooperate to establish appropriate funding mechanisms to assist CPCs developing States in the implementation of this Resolution. These mechanisms shall, *inter alia*, be directed specifically towards:

- a. developing and enhancing capacity, including for monitoring, control and surveillance and for training at the national and regional levels of port managers, inspectors, and enforcement and legal personnel;
- b. monitoring, control, surveillance and compliance activities relevant to port State measures, including access to technology and equipment; and
- c. listing CPCs developing States with the costs involved in any proceedings for the settlement of disputes that result from actions they have taken pursuant to this Resolution.

## PART 7

### *DUTIES OF THE IOTC SECRETARIAT*

#### **19. Duties of the IOTC Secretariat**

**19.1** The IOTC Secretariat shall without delay post on the IOTC website:

- a. the list of designated ports,
- b. the prior notification periods established by each CPC,
- c. the information about the designated competent authority in each port State CPC,
- d. the blank copy of the IOTC Port inspection report form.

**19.2** The IOTC Secretariat shall without delay post on the secure part of the IOTC website copies of all Port inspection reports transmitted by port State CPCs.

**19.3** All forms related to a specific landing or transshipment shall be posted together.

## Port State measures

### Procedures for the implementation of the *Indian ocean Tuna Commission*

**19.4** The IOTC Secretariat shall without delay transmit the inspection reports to the relevant regional fisheries management organisations.

**20.** This Resolution enters into force the 01 March 2011 and shall be applied to CPCs' ports within the IOTC area of competence. The CPCs situated outside the IOTC area of competence shall endeavour to apply this Resolution.



## APPENDIX II:

# Fishing gear design and specifications that can be encountered in the Indian Ocean region

### *Pelagic longline*

A drifting longline (pelagic longline) consists of a mainline that is held near the surface or at a certain depth by means of regularly spaced surface buoys or floats. Branch lines, (also known as droppers, snoods or ganglions) with baited hooks are suspended from the main line at regular intervals between the buoys. The entire line can extend from 20 to over 120 km.

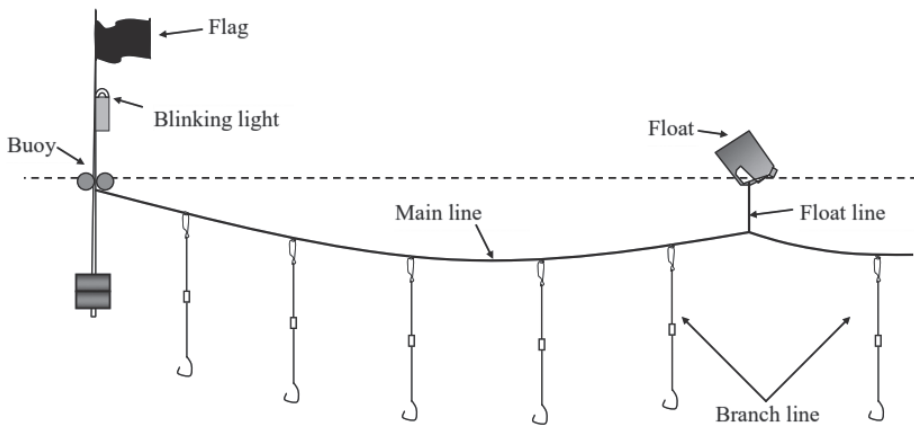

Source: IOTC, 2021

## Port State measures

### Procedures for the implementation of the Indian ocean Tuna Commission

#### Mainline

There are two distinct longline systems, separated by the specifications and storage method of the mainline.

The first system uses a multi-strand mainline that can consist of tarred rope or braided nylon monofilament. The mainline is stored in large coils or is layered down in a large bin or storage well. A "line hauler" on the starboard side hauls the line.

The second system (sometimes termed "Mono" system) uses monofilament nylon mainline approximately 6mm in diameter that is stored on a large drum or reel.







#### Branch lines / traces

A typical branch line can vary between 30 m to 50 m in length and are attached to the mainline with a stainless steel tuna clip.

Branch lines can be simple with one type of line material between the snap and the hook or they can be more complex with multiple types of line and swivels attached. Multiple materials usually include an initial section of nylon / polyester braid combinations which is then attached to a length of monofilament leading to a hook. Barrel swivels are used to connect sections, some of which may be weighed with lead.

On Large Scale Tuna Longline Vessels (LSTLV's) branch lines are generally prepared in coils and packed into baskets. On vessels using the mono-system the branch lines are generally of a uniform material and these are layered into large rectangular "tubs." On vessels using shorter longlines the branch lines and buoy lines may be wound up on to large reels one on top of the other.



<p>Bullet-buoy / Hard-floats / Radio-buoy / light-buoy</p>	<p>Buoys or floats are attached to the main line by buoy-lines at intervals to keep the mainline near the surface. The length of the buoy-lines can also be varied to influence the fishing depth.</p> <p>These include</p> <p>Hard floats: are made from a rigid plastic and can withstand a high pressure should a large fish pull them under.</p> <p>Bullet-buoys: are made of a soft polyurethane foam material.</p> <p>Various "Marker-buoys," GPS beacons, radio buoys, light buoys and radar reflectors (highflyers) are used individually or in combinations to mark the location of the fishing gear and are attached at fixed intervals along the line. These also assist in locating the end of the line if it is accidentally cut or broken.</p>	 <p>A diagram showing a cylindrical radio beacon floating on the water surface. A vertical line extends from the beacon down into the water, ending in a hook. The text "RADIO BEACON" is positioned above the beacon.</p>
<p>Hook types</p>	<p>Different shapes and sizes of hooks are used depending on target species. The most common are the Japanese hook with a ring, circle hooks and "J"-hooks.</p>	 <p>Four different types of fishing hooks are shown side-by-side. From left to right, they are labeled: Circle hook, Japan tuna hook, J hook, and Teranima hook.</p>
<p>Line setter</p>	<p>A line setter / shooter – is situated on the stern and is used to pull mainline from drum or its storage bin. It deploys the mainline at a consistent speed during setting, (m/s). By varying the line setter speed to the vessels setting speed the depth of the hooks can be controlled.</p>	 <p>A photograph of a mechanical line setter device, showing a large drum and various gears and components.</p>
<p>Line Hauler</p>	<p>Mainline hauler – uses hydraulic motor to assist with pulling gear on board. Vessels that use a multi-strand rope or braided nylon monofilament mainline that is stored in layers in a large bin or storage well will use a line hauler. The line hauler is generally positioned on the starboard side.</p>	 <p>A photograph of a hydraulic line hauler mechanism, featuring a large flywheel and various hydraulic components.</p>

## Port State measures

Procedures for the implementation of the Indian ocean Tuna Commission

<b>Branch line hauler/coiler</b>	A branch line hauler/coiler – winds branch lines into tight, consistent coils and assist in quickly recovering and packing branch lines for the next set.	
<b>Bait Casting Machine (BCM)</b>	The bait casting machine is used to cast the bait away from the vessel outside of wake zone. It is generally situated on the stern rail on the port side of the line setter.	

### *Industrial tuna purse seine*

Tuna purse seining is an active fishing technique that involves surrounding tuna schools with a net, impounding the fish by pursing the net, and drying up the catch by hauling the net back onboard net so that the fish are crowded into the bunt of the net and can then be brailled out. The period from deployment of the net until the net is recovered onboard, is called a set.

**Purse Seine:** A wall of netting, that can measure 1500 to 2000 m long and 120 to 250 m in depth, equipped with a floatline along the upper edge, to keep the top of the net on the surface and a chain attached to bottom of the net to weigh it down. Steel rings (purse rings) are attached to the chain and a steel cable (purse line) feeds through the rings to enable fisherman to close the net from below.

**Purse Line/ cable:** The steel cable passing through the purse rings which, when drawn on, cinches (purses) the lower portion of the net closed.

**Skiff:** Powerful boat of approx. 8 m length and engine of approx. 600 HP, used to assist in setting the net around a school of fish.

**Hauling Device:** A hydraulic power block attached to the end of a boom is used to haul the net back and restack it in the net bin ready for the next set.

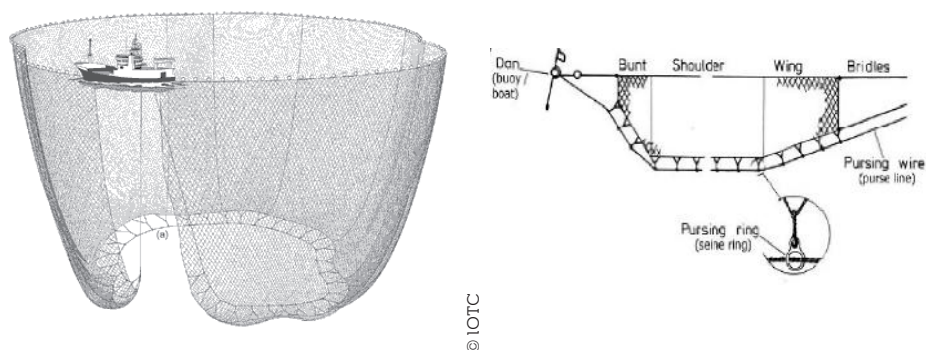

*Tuna purse seine gear components*

### **Demersal longline**

Demersal longlining is a passive fishing technique making use of baited hooks to attract and catch fish. Demersal longlines are weighted and set onto or close to the seabed and are anchored at each end.

The lengths of demersal longlines can vary greatly. Inshore artisanal longlines may have only a few hundred hooks and extend less than one kilometre. Larger commercial longliners can set lines over 30 km long with more than 30 000 hooks in depths over 2000m.

A number of variations exist in demersal longline design, and these include:

- Single lines
- Double lines
- Trot lines
- Vertical drop lines

## Port State measures

Procedures for the implementation of the Indian ocean Tuna Commission

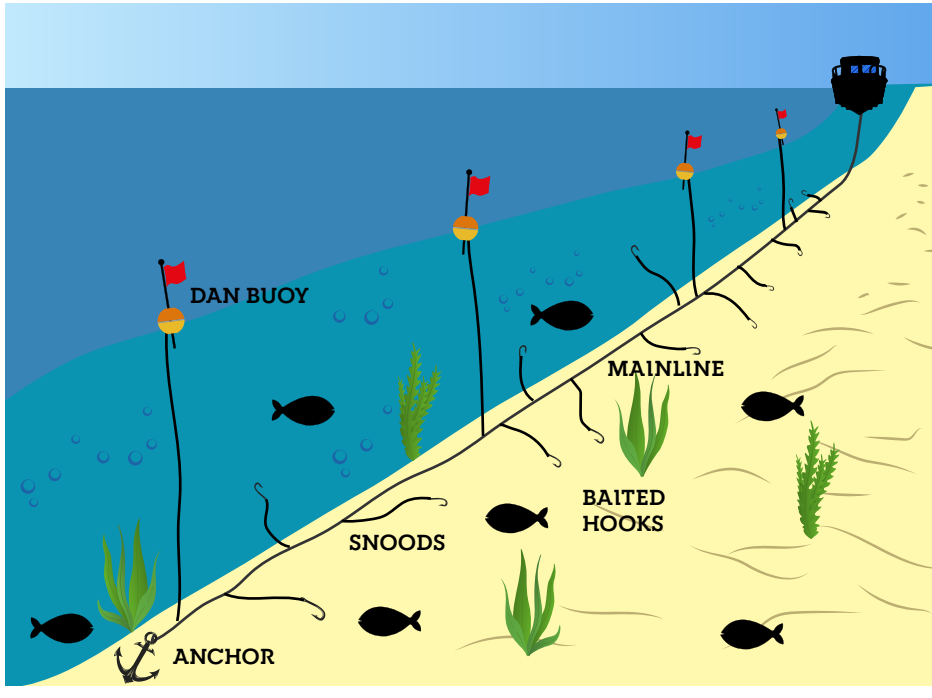

Source: Austrailia, 2021

*Demersal longline diagram.*

### Single line system

Consists of a single mainline with snood spaces at 1 to 2 meter intervals along its length. Made up out of rope or cord that is normally negatively buoyant. Weights may be attached at intervals along its length to increase its sink rate and hold the line onto the seabed. Modern systems have a lead core integrated into the mainline to increase weight, called integrated weighted lines (or IW lines).

Single line systems can be automated and together with automatic baiting machines a large number of hooks can be set and hauled compared to other systems, and fewer crew are required.

However, single lines are restricted to relatively flat or soft grounds. If the line gets fouled and breaks, it can be hauled from the opposite end.

### Double Line system

Two lines set together, a floating top line, (mainline) that is connected to a bottom ground / fishing line. Top and bottom lines are connected by drop-pers (branch lines) at fixed intervals. The bottom line has weights attached to weigh it down with snoods and hooks attached at short intervals between one and 2 meters apart. If the bottom line gets fouled on the seabed and breaks, hauling can continue on the top line and the next dropper will then recover the broken end of the bottom line. Can be set over foul grounds where single lines cannot be used. Double line systems cannot easily be automated and are labour intensive, requiring more crew.

### Trot Line system

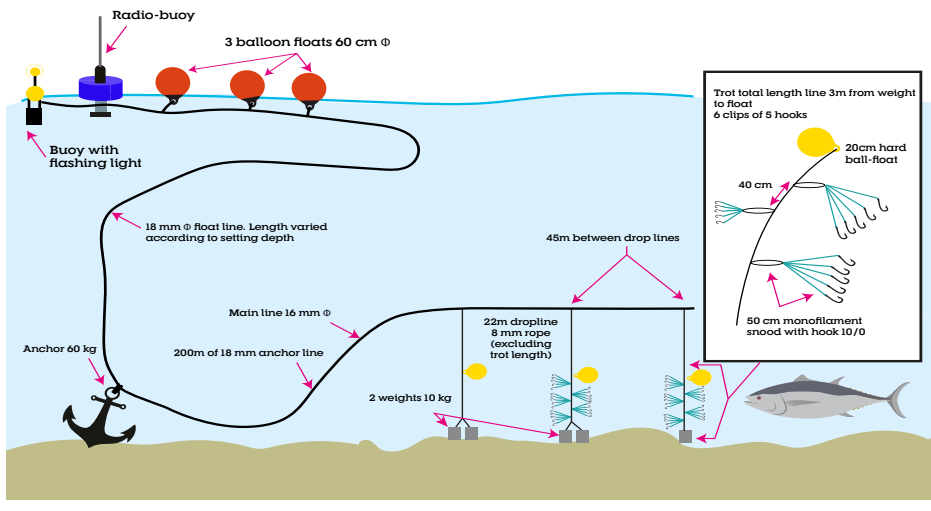

*Configuration diagramme of trotline gear*

Modification of the double line system that uses a floating topline and has branch lines of 25 meters long attached at regular intervals of 20 to 50 meters apart. At the end of each branch line a length of hook line is attached with hooks or "trots of hooks" attached. At the bottom of the hook line a weight is

## Port State measures

Procedures for the implementation of the Indian ocean Tuna Commission

attached to weigh it down. The hooks are therefore set vertically above the seabed. A small high pressure float may be attached above the hook line to tension it vertically. The distance of the hooks off the seabed is determined by the length of the hook line and the spacing of the hooks and normally is not more than 3 to 4 meters. This system can be set over rugged seabed with less chance of being fouled. It is labour intensive and cannot be automated. It allows for the addition of mitigation measures to prevent marine mammal predation.

### **Vertical Droplines**

Set vertically with a single weight at the bottom, a series of hooks attached to snoods on the line and a float at the top.

The length is determined by the water depth and the position of hooks by the depth range of the fish being targeted.

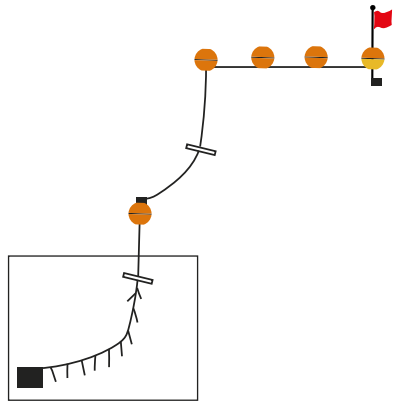

Can be set on seamounts or pinnacles or next to steep drop-offs and cliffs where longlines cannot be set.



Source: IOTC, 2021



## Demersal longline gear components

Magazines	Single lines are made up into magazines with up to 1000 hooks. The hooks are hooked into a groove on the magazine and as the line is set they slide off the end and pass through an automatic baiting machine where the hooks pick up bait before entering the water. Magazines are connected to each other during the setting process.	
Pots (baskets) / cases	For double line systems, sections of bottom line are made up into pots, baskets or cases. A single pot holds several sections of bottom line. Snoods and hooks are attached at fixed intervals (0.8 to 1.2 meters apart). Sections of line are joined together with short "strops" and the branch lines that attach the bottom line to the topline and to weights are attached at these junctions. Pots or baskets fit into each other, and are joined together to make up a continuous line during setting	
Branch lines, (Droppers)	Branch lines which connect top and bottom lines are about 25 meters long, and allow the top-line to float free of the bottom. They are attached while the line is being set.	

Stones	"Stones" are weights attached to the bottom line to weigh it down. Originally round stones were tied up in a piece of old netting and attached to the line with a short strop. Many vessels now use concrete weights (4-6 kg) with a strop cast into the cement.
Snoods	Snoods are short lengths of mono-filament nylon (approx. 1 meter long) attached to the bottom line with the hook at the other end.
Anchors & down-lines	The entire line is anchored at each end using anchors or weights. Anchor lines (or down-lines) connect anchors to marker buoys on the surface.
Buoys / balloons	The buoys on the surface are often called "balloons". Normally several buoys are attached to each other.
Dan-buoy / Light-buoy / Radio-buoy	A dan-buoy is a buoy with a pole set through the centre; one end of the pole is weighed and the other has a flag and/or light attached to make it more visible.

## Port State measures

Procedures for the implementation of the Indian ocean Tuna Commission

### Trawl

Stern Trawler	Deploys and hauls nets over a ramp at the stern of the vessel. Are able to operate in adverse weather and can shoot and haul their net and catch quickly.	
Side Trawler	Deploys and hauls nets over the side.	
Beam Trawler	Deploys smaller trawls targeting smaller species such as shrimp or prawns. The net is kept open by a solid frame or beam and no doors are required.	
Ramp	Angled ramp at stern of a stern trawler for deploying and hauling the net back onto the trawl deck. The photograph also shows the trawl doors.	 <p>www.trawlerheritage.co.za</p>
Warps	The main cables (steel wire rope) used to tow a trawl.	
Warp drums / Trawl winches / Donkey winches	The warps are stored and winched in on the warp-drums, normally one on each side of the trawl deck. Smaller winches on the deck, trawl winches or "donkey winches", are used to lift and empty the net.	
Net drum	The trawl net is generally longer than the trawl deck and to haul it in and store it, it is rolled up onto a net drum.	

Gantry	A distinguishing structure on a stern trawler. Forms a high bridge across the trawl deck and is used to haul up the cod end to empty it into the ponds.	
Top-rope	The top-rope is attached to the top of the net opening.	
Foot-rope	The foot-rope is attached to the bottom of the net opening.	
Trawl buoys	Trawl buoys are attached to the top-rope to raise it off the bottom and assist in opening the net vertically.	
Cod-end	Bag at the end of a trawl net in which fish collects during a trawl. Usually made up of stronger net material and can be opened at its end to empty out the fish.	

## Port State measures

Procedures for the implementation of the Indian ocean Tuna Commission

<p>Trawl net</p>	<p>The main categories of trawl nets are:</p> <p><b>Bottom trawls (otter trawl):</b> Shaped like a long triangle with the widest part forming the net opening and tapering down to a narrow bag (or “codend”). Towed along the seabed and kept open by two “trawl doors”.</p> <p><b>Mid-water trawls:</b> Similar to bottom trawls but it is towed in the mid-water, between the surface and seabed. Trawl doors are also used to open the net.</p> <p><b>Beam trawls:</b> The net is kept open by a solid bar or beam and no doors are required.</p>	
<p>Net</p>	<p>Net mesh size and orientation vary according to the target species and net type. Mesh orientation is normally “diamond” shaped or “square”. Net mesh sizes and orientation also vary within the construction panels of the net. Square mesh panels may be inset to facilitate small fish escaping out of the net as the square mesh maintains its shape while being hauled and the diamond mesh has a tendency to close with the hauling the net.</p>	
<p>Bobbins / Rubber discs / Rock Hopper Gear</p>	<p>Bobbins are steel balls that are sometimes attached to the foot-rope for trawling over rocky grounds. Rubber discs of the same diameter are placed between the bobbins to make up “Rock Hopper” gear.</p>	

## Trawl doors

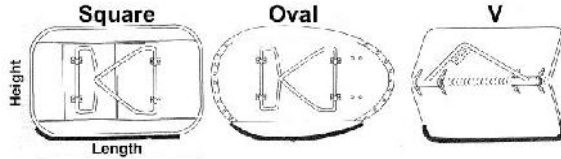

Two trawl doors are attached to the net opening. The orientation of the doors and water pressure from the flow over the doors causes them to move out perpendicular to the forward movement of the vessel, thus opening the net. Several types exist, including Oval, "V" and Square doors. They are heavily reinforced for towing on the seabed. Pelagic trawls use rectangular hydrodynamic pelagic doors that are lighter in construction, as they do not have contact with the seabed.

## Gillnets

Gillnets consist of a series of net panels that are suspended in the water column. It is a passive method of fishing that does not use bait or actively trap fish. The fish swim into the net and become entangled.

Gillnets can be broadly classified into several categories: set nets; trammel nets and drift nets.

A **set net** is an anchored gillnet.

A **trammel net** consists of three layers of net. A slack, small mesh, inner panel of netting is sandwiched between two outer layers of netting, which are taught and have a larger mesh size. The inner panel may be made of twisted or monofilament nylon, whilst the outer panels are generally made of twisted nylon filament.

**A drift net is a gillnet that is not anchored. The use of large-scale driftnets, those exceeding 2.5 kilometres in length, were banned under a 1991 General Assembly Resolution and are currently banned in the IOTC Area under Resolution 17/07.**



© IOTC

*Gillnetter operating in the Indian Ocean.*

Gill nets entangle fish in three different ways. The fish may become wedged, held by the mesh around the body; gilled, caught by the gills; and tangled, held by teeth, spines or other protrusions without necessarily penetrating the mesh. The mesh size of gillnets can be highly effective at selecting or regulating the size of fish caught. Fish that are smaller than the mesh of the net are able to pass through the net unhindered, while those, which are too large to push their heads through the meshes as far as their gills, are also less likely to be caught. Trammel nets also entangle fish in bags or pockets of netting. This occurs when fishes swim through one of the outer panels, hit the inner panel, and are carried through to the other outer panel, which creates a bag or pocket, thereby trapping the fish. Trammel nets are therefore less selective in the size of fish caught.

## Port State measures

Procedures for the implementation of the Indian ocean Tuna Commission

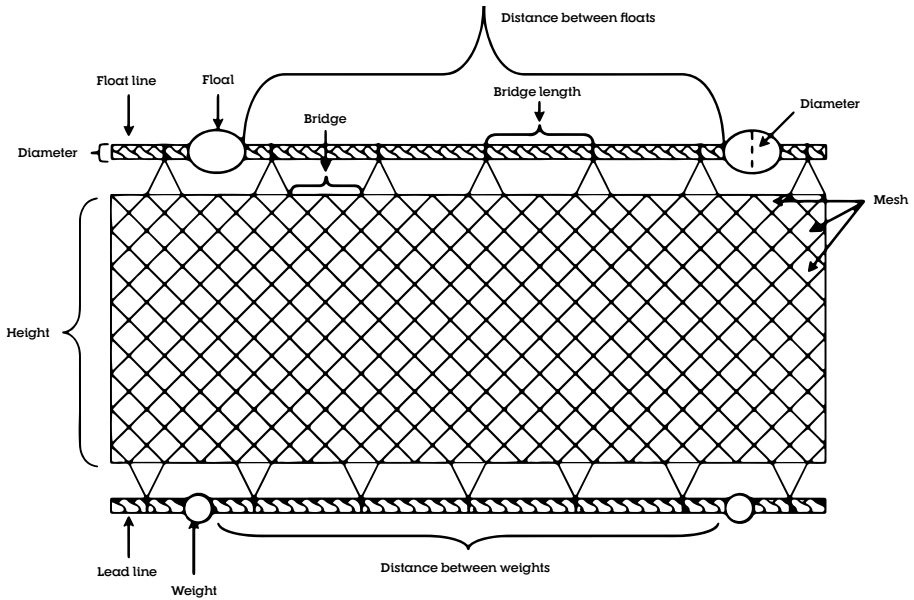

© IOTC

Gillnets, including trammel nets, are widely used all over the world, both in inland and in the marine environment, especially with artisanal fisheries. Driftnets were used extensively on the high seas by a number of countries in the 1980's to target tuna. However, they were also associated with high numbers of incidental capture of marine mammals and turtles. In 1991 the UN General Assembly adopted Resolution 46/215 that called on all members of the international community to implement previous resolutions urging countries to ban driftnet fishing and ensure that a global moratorium on all large-scale pelagic drift-net fishing is fully implemented on the high seas of the world's oceans and seas by December 1992.

The IOTC has 757 vessels registered to fish with gillnets.

Gillnets are generally made up of a series of panels with a weighted "foot-rope" attached along the bottom, and a "headline", to which floats are attached. Panels of net are commercially available in "skeins" and a vessel



can easily store a large number these on board to make up nets while at sea to replace lost or damaged nets. The headline, (float line) is buoyed using solid foam, oval or cylindrical buoys. The footrope is weighed using lead weights or integrated lead core rope. The relation of floats to the weighted footrope will determine if the net will float or sink.

In shallow water, set nets and trammel nets are anchored to the seabed and the anchor lines determine the vertical orientation, while drift nets are set on or just below the surface and are not anchored and allowed to drift with the currents.

Gillnets are constructed out of both monofilament nylon and multifilament materials. The size of the mesh is determined by stretching the mesh and measuring the distance from knot to knot in either centimetres or millimetres. The spacing between two points where the net is attached to the headline is called the bridge length. The hanging ratio determines the depth and mesh tension on a panel of net. The hanging ratio is effectively the relation between the length of the net attached to the headline or footrope divided by the maximum length of the net. This can be calculated by dividing the bridge length of a single mesh by its stretched length. The size and spacing of floats on the headline and weight of on the footrope will also vary depending on where the net is to be positioned in the water column. A number of gillnet panels can be made up into a single net and several nets can be connected into a continuous net.

Driftnets can extend up to 60 km.

On small boats, gillnets are handled by hand while hydraulic net haulers and/or net drums are used on larger vessels to handle and store nets. To determine catch per unit effort in this fishery observers will be required to record a range of data fields that include information on the specifications of the net, the setting strategy as well as vessel parameters.

A bottom-set gillnet can be defined as a wall of netting with a weighted groundline holding it on the seabed and kept more or less vertical by a float-line.

## Port State measures

### Procedures for the implementation of the Indian ocean Tuna Commission

Alternative terms: Bottom-set nets gillnets, Entangling nets, Trammel nets

Net panel (skein) of net: variable length, depths, mesh sizes and materials obtainable from net manufacturers.

Fleet: Number of net panels connected together. Single working unit that is set and hauled.

Floatline (Top rope): Attached to the top row of meshes and connects net panels into a continuous net (fleet).

Weightline (groundline): Weighted rope attached to the bottom row of meshes connecting fixed number of net panels of a fleet in conjunction with the float line.

Terminal anchor and buoys: weights: anchor and marker buoys attached to the end of each fleet, (similar or the same as those used to mark the ends of a longline).



*Drum or net roller used to haul in the gillnet*



*Guide to haul a gillnet over the side inboard.*



© IOTC

*Chute or channel used to guides the net from the hauling point to the stern where it is stored ready for deploying.*

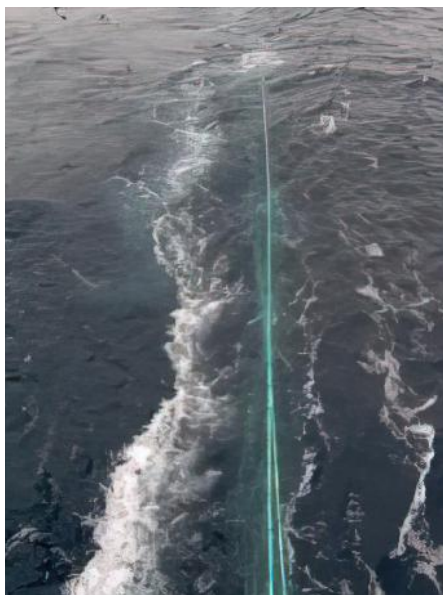

© IOTC

*Gillnet being set showing top rope and weighted bottom rope.*



© IOTC

*Chain links used to anchor the net.*

### *Pole and Line*

A pole and line consists of a hooked line attached to a pole. Poles are made of wood (including bamboo, also constructed of split cane) and increasingly of fiberglass. In industrial fisheries, "Pole and Line vessels" fishing for tuna can range from 15 to almost 40 meters in length with special arrangement for using as many poles as possible from the side of the boat and for keeping bait on board, in the best condition, if possible alive. The fish holds are divided up into a main central hold and smaller holds or tanks. The main hold is used to preserve the catch and is usually refrigerated on the larger vessels. Smaller vessels may use ice to preserve the catch on shorter trips.

Similar to purse seine operations, the daily activity of pole and line vessels is taken up with searching for fish with actual fishing events taking place over a relatively short period of time. However unlike purse seiners, pole and line vessels also spend a significant amount of time catching live bait. The high seas tuna fishing grounds are often far from the bait fishing grounds, presenting some unique challenges to this fishing technique. Fishing for bait takes place in sheltered waters, targeting sardines, anchovies and small mackerel. This is often done at night and lights are used to attract certain bait species. Underwater lights are also set at times.

Purse seine nets are normally used to catch the hardier species of bait fish and are deployed by the bait boat, skiffs, or from the beach. Lift nets (boke-ami nets) are used to catch the delicate species of baitfish. These nets are deployed from the side of the bait boat. Bait fish are loaded by scoop nets (dry) or by buckets filled with water (wet) into the bait tanks of circulating sea water.

Methods of searching for tuna are similar to that of purse seiners and entail:

- acoustic sonar and depth sounders to detect shoals of fish in the immediate vicinity of the vessel and are used to assess the school before setting the net;
- searching for sea birds associated with tuna;
- searching for schools of dolphins or other marine mammals;
- locating or deploying fish aggregation devices, FADs or locating

floating objects such as floating tree trunks or dead animals around which schools of fish are likely to aggregate.

Once a school is sighted the vessel approaches at full speed. The sonar indicates whether tuna are present, the size of the fish and the density of the school. The echo sounder indicates the depth of the school. Both devices are monitored closely throughout the operation.



© IOTC

*Pole and line vessel of the fleet of Maldives.*



© IOTC

*Poling with sprays on.*

## Port State measures

### Procedures for the implementation of the Indian ocean Tuna Commission

Once the vessel is stationary over the school, the sprayers are turned on. As the school nears the surface, the order is given to commence chumming. The combination of the spray agitating the surface and chum is used to get the fish into a feeding frenzy. Fishing commences when the tuna are observed near or on the surface starting with live bait. Feathered jigs normally replace live bait when a feeding frenzy is induced.

Hooked fish are pulled from the water rapidly and many tons can be landed in a short period of time. A single pole fisherman can comfortably land fish up to 15kg in weight. Poles are often paired for heavier fish.



© IOTC

*Poling the tuna into the boat.*

Special lines are also strung from the ends of the poles to overhead blocks for more lifting power when large fish are encountered.

When fishing on a FAD, the initial catch normally consists of rainbow runner and dorado. These fish occupy the top layer and have to be landed before the yellowfin and skipjack are caught. At times fishing may be halted before the school is exhausted, and the boat drifts with the school. Various methods are used to encourage more tuna to aggregate under the bait boat before fishing recommences. These include:

- fishing for short intensive periods;
- turning on water sprayers and chumming between fishing sessions;
- drifting day and night;
- turning on powerful deck lights at night.

Pole and line boats often collaborate with purse seiners. After filling the hold they might seek an agreement from a purse seiner before providing the location of a school.



© IOTC



© IOTC

*Catch in the hold of a pole and line vessel.*

*Catch on the deck of a pole and line vessel.*

## Port State measures

Procedures for the implementation of the *Indian ocean Tuna Commission*

### *Bait Boats*

Bait boats working exclusively for a purse seiner do not land their own catch and are paid by the purse seine fishing company. They drift with a school of associated tuna until it is large enough to be commercially viable. Bait boats also deploy FADs on behalf of purse seiners.

The communication between groups of vessels working together can cover hundreds of miles, with the purse seiners providing valuable meteorological information to the smaller and more vulnerable pole and line vessels.



## APPENDIX III:

# Navigation, latitude and longitude

Any position, anywhere on the earth's surface, can be referenced in degrees of Latitude and Longitude. Lines of Latitude are used for measurements north and south of the equator and are represented as horizontal lines running east-to-west (or west to east) on maps. The Equator ( $0^\circ$  Latitude) is a line around the earth that is exactly half way between the North and South poles and divides the earth into the Northern Hemisphere and the Southern Hemisphere. Technically, latitude is an angular measurement in measured degrees (marked with  $^\circ$ ) ranging from  $0^\circ$  at the equator (low latitude) to  $90^\circ$  at the north and south poles. Latitude can never exceed  $90^\circ$  North or South:

- Latitude North of the equator abbreviated symbol (N),
- Latitude south of the equator abbreviated symbol (S).

Longitude is used in navigation for east-west measurement. Lines running from north to south on a chart represent constant lines of longitude.

All lines of longitude cross at the poles. "Greenwich" or "Prime" Meridian, is the line of longitude (meridian) that passes through the Royal Observatory, Greenwich, in England. This has been chosen as the  $0^\circ$  Longitude and lines of longitude are measured in degrees East (E) and West (W) of Greenwich to a maximum of  $180^\circ$ . The line of longitude at that position is referred as the  $180^\circ$  longitude or International Date Line. The Greenwich Meridian and  $180^\circ$  line of longitude divides the earth into an Eastern and Western hemispheres.

Remember both latitude and longitude are measured in degrees ( $^\circ$ ) and minutes ( $'$ ), and points of minutes, or seconds ( $''$ ). *For example:  $34^\circ 21.5274' S 018^\circ 30.3789' E$ . The decimal points of minutes can also be converted to seconds*

## Port State measures

Procedures for the implementation of the Indian ocean Tuna Commission

by multiplying the decimal point by 60, e.g.  $34^{\circ} 21'31.644''S$  and  $18^{\circ}30'22.734''E$  to facilitate plotting on the Mercator projection charts.

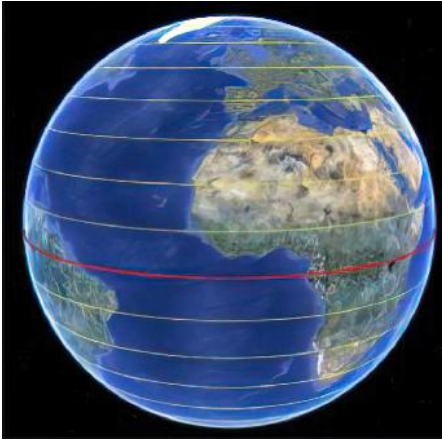

Source: IOTC, 2021

Latitude lines

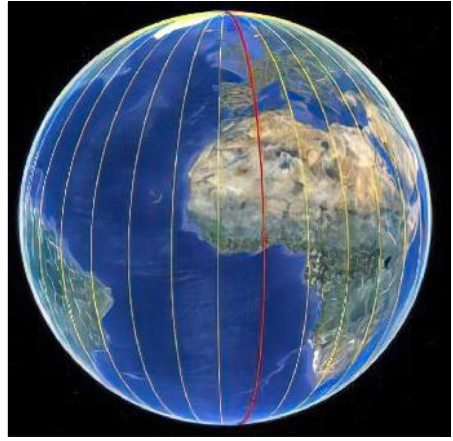

Source: IOTC, 2021

Longitude lines

## Navigation charts

A most common mercator projection navigation chart shows a small part of the earth's surface. These navigation charts are orientated so that the top of the chart is always directed towards the North. Lines of latitude and longitude are straight lines with lines of latitude running horizontally across the chart [East - West] and lines of longitude running vertically [North - South]. Lines of latitude and longitude are therefore perpendicular ( $90^{\circ}$ ) to each other. The units of latitude are shown on the sides of the chart with the latitude increasing to-

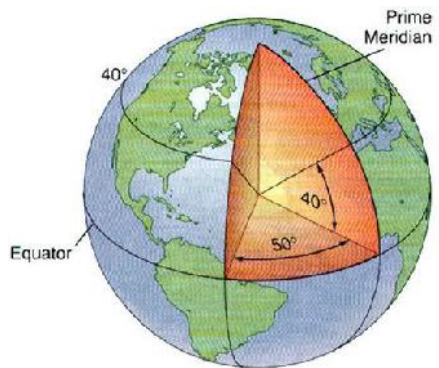

Source: IOTC, 2021

Cutway view of the Earth. The east-west line  $40^{\circ}$  north of equator is latitude  $40^{\circ} N$ ; the north-south line  $50^{\circ}$  west of the prime meridian is longitude  $50^{\circ} W$

wards the poles. Units of longitude are shown along the top and bottom of a chart with the angle increasing to the East or West. A position on a chart can be determined by drawing a line horizontal to the side of the chart to get the latitude and by drawing a vertical line from the position to the top or bottom of the chart to get the longitude.

### *Vessel course and tracks*

The course of a vessel is the direction in degrees towards which it is steering. A course is referenced in the three-Figure notation from 000 to 360 degrees and is read off the compass rose that is marked on the chart.

The route or tracks followed by a vessel can be plotted on a chart or recorded on an electronic plotter. Electronic navigation systems allow for tracks to be saved on the unit and often these can be downloaded onto portable storage devices.

An inspector could record a series of positions and re-plot these on a chart to provide verification of a vessel's movements. Similarly, depending on the system employed on the vessel, its movements could be copied off the plotter or the computer used for navigation. These can then be cross checked to VMS information.

### *Speed and distance*

In nautical terms distance is measured in "*nautical miles*" (nm) and speed in "*nautical miles per hour*" (knots). One nautical mile equals 1.852 kilometres. By definition one (1) nautical mile is equal to one (1) minute of latitude and can be measured using the latitude scale on the side of the chart. However it is important to note that due to the projection (Mercator projection) of a standard navigational chart, distance **can only be measured from the closest latitude scale and cannot be measured from the longitude scale.**

Theoretically, the shortest distance between any two points on the earth's surface is the arc of the meridian or angle created by the lines from the two points to the centre of the earth. In the case of straight north-south tracks

## Port State measures

### Procedures for the implementation of the Indian ocean Tuna Commission

where the longitude remains the same the distance between two positions can be calculated by determining the difference in latitude (d-lat) in minutes, which is equivalent to the distance in nautical miles.

To accurately calculate the distance between any two positions where there is a difference in both latitude and longitude the calculation is more complex; involving d-lat and d-long formulas.



Source: IOTC, 2021

$$A = \sin(d\text{-lat}/2)^2 + \cos[\text{start lat}] * \cos[\text{end lat}] * \sin(d\text{-long}/2)^2$$

$$C = 2 * (\arctan 2[A^{0.5}, (1 - A^{0.5})])$$

$$\text{Distance in Kilometres} = C * 6371$$

$$\text{In Nautical miles} = C * 3440$$

However, this is facilitated on Mercator charts by using a set of dividers and taking the distance between the two points and using the closest latitude scale on the side of the chart which will then provide the distance in nautical miles.

Where;

$$d\text{-lat} = \text{latitude}_1 - \text{latitude}_2$$

$$d\text{-long} = \text{longitude}_1 - \text{longitude}_2$$

The distance covered by a vessel, its speed or the time that it will take to travel from one position to another, can be calculated from the (speed time distance) equations.

Speed  $S = D / T$  nautical miles per hour (knots)

Time (hr:min)  $T = D / S$  Time in hours and /or/ minutes

Distance  $D = S \times T$  Nautical miles (nm)

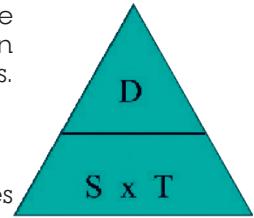

It is unlikely that it will be necessary to calculate accurate distances in a routine inspection. However, if the difference in coordinates of two positions compared to the times recorded indicates that the vessel had to travel at impossible speeds then it would need to be verified.

*For example; a purse seiner shoots its net in a position 14° 20' S and 080° 40'E at 1800 and 6-hours later makes a second set in a position 18° 00 S and 081° 00'E at 2400. The difference in latitude between the two positions is 3° 40' which is approximately 220 nautical miles. To cover this distance in six hours the vessel would have travelled at over 36 knots. Is this possible?*

### Time Zones

A time zone is a region on Earth that has a uniform standard time for legal, commercial, and social purposes. On some vessels all the times relate to the zone time of their flag State or company headquarters.

When inspecting logbooks and fishing event times, check or query the time zone that the vessel was working in and if the vessel changed time during its trip. This would have to be taken into account when comparing fishing times at different positions. Greenwich Mean Time (GMT), now called Coordinated Universal Time (UTC) is the time at the Prime Meridian through Greenwich which establishes a common standard for time of events, e.g. VMS times of

## Port State measures

Procedures for the implementation of the Indian ocean Tuna Commission

positions are in UTC which can then be converted to local time using the time zone calculations.

### Basic nautical terms

TERM	GENERAL MEANING
Starboard	The right hand side of the vessel when looking forward.
Port	The left hand of the vessel when looking forward.
Forward	The forward part of the vessel (that is, towards the bow).
Aft	The after or rear part of the vessel (that is, towards the stern).
Midships	In the middle section of the vessel. The middle line across the vessels from port to starboard.
Aloft	Usually referring to going up the superstructure or the mast.
Bridge	The compartment or position from which command of the vessel is normally exercised by the master. The bridge provides a clear view ahead and to the side of the vessel and often a 360 degree view.
Deck	Any 'floor' you can walk on inside or outside the vessel. In the open air these are generally referred to as the Upper Deck.
Chart	Is a marine map showing coastline with prominent coastal features that may be used for coastal navigation. A marine chart also shows the depth of water with accurate depth contours used for marine navigation.
Nautical Mile (nm)	A nautical mile by definition is equal to one minute (1/60 of a degree) of latitude along any line of longitude. In conventional distance this is equal to approximately 2020 yards or 1.85 kilometres. The standard measurement of distance in all sea and air navigation because it is based on latitude. Due to the projection of a Mercator chart distance can be measured on the latitude scale on the side of a chart and should be taken as close as possible to where the distance is being recorded.
Knot (kt)	One Knot = 1 Nautical Mile per hour. It is a speed not a distance.
Gyro Compass	A compass based on a highly stable, true north-seeking gyroscopic wheel. Gives True bearings and courses.
Magnetic Compass	A compass that seeks the Magnetic North Pole. Subject to errors from Variation and Deviation.
Meridian Passage	The instant at which the sun is either due North or South of the vessel (in effect, the vessel's own midday). Using a sextant, the precise latitude of the vessel can be calculated using the Nautical Almanac.
Vessel's Log	An accountable document which is the responsibility of the master. It is a legal document and can be used as evidence, including in court proceedings. It records all activities of the vessel along with navigational records and calibrations of key equipment. It is an offence to alter or forge Log entries.

# APPENDIX IV

## Forms

### Form - Advance Request for Entry into Port (Annex I of IOTC PSMR)

ADVANCE REQUEST FOR PORT ENTRY					
1. Intended port of call		<input type="checkbox"/> (Enter port name) <input type="checkbox"/> (Enter port name) <input type="checkbox"/> Other			
2. Port State		(Enter port State name)			
3. Estimated date and time of arrival		___/___/_____H_____mn			
4. Purpose(s)		<input type="checkbox"/> Landing <input type="checkbox"/> Transhipping <input type="checkbox"/> Packaging <input type="checkbox"/> Processing of fish <input type="checkbox"/> Refueling <input type="checkbox"/> Resupplying <input type="checkbox"/> Maintenance <input type="checkbox"/> Drydocking <input type="checkbox"/> Force majeure			
5. Port and date of last port call		___/___/_____			
6. Name of the vessel			7. Flag State		
8. Type of vessel			9. IRCS		
10. Vessel contact information					
11. Vessel owner(s)					
12. Certificate of registry ID			13. IMO ID		
14. External ID			15. IOTC ID		
16. VMS		<input type="checkbox"/> No <input type="checkbox"/> Yes: National <input type="checkbox"/> Yes RFMO(s)		Type:	
17. Vessel dimensions		Length		Beam	Draft
18. Vessel master name and nationality					

**Port State measures****Procedures for the implementation of the Indian ocean Tuna Commission**

19. Relevant fishing authorisation(s)					
Identifier	Issued by	Validity	Fishing area(s)	Species	Gear

20. Relevant transhipment authorisation(s)		
Identifier	Issued by	Validity

21. Transhipment information concerning donor vessels								
Date	Location	Name	Flag State	ID number	Species	Product form	Catch area	Quantity

22. Total catch onboard					23. Catch to be offloaded
Species	Product form	Catch area	Quantity	Quantity	



## Form - Advance Request for Entry into Port (e-PSM application)



### Advance Request for Entry into Port (AREP)

Vessel information			
Intended port of call	Port de Pointe des Galets		
Port of call state	France (EU)		
Estimated local date and time of arrival	22 April 21 - 01:45 UTC		
Purposes	- Landing		
Port of last port call / Date of last port call	MGSMS	19 Apr 2021	
Vessel Name	Île Sainte Marie	Flag	Madagascar
Type of vessel	Cargo Freezers	IRCS	5RYX
Vessel contact information	<ul style="list-style-type: none"> <li>- <b>Master:</b> ANDRIAMAHERY Lalaina Michel [Madagascar] Phone:+261343548884 - Mobile:+262693906297 Email:harrys.spsm@yahoo.fr</li> <li>- <b>Owner:</b> Societe de Peche de Saint Marie (SPSM) [Madagascar] Phone:+261343548884 - Mobile:+261343548821 - Fax:+261 Email:harrys.spsm@yahoo.fr</li> <li>- <b>Beneficial Operator:</b> Societe de Peche de Sainte Marie (SPSM) [Madagascar] Phone:+261343548884 - Mobile:+261340548821 Email:spsmsaintemarie2@gmail.com</li> <li>- <b>Operator:</b> VANGHOU Jacques Philippe [Madagascar] Phone:+261343548802 Email:philippe.vanghou@spsm.mg</li> </ul>		
Certificate of Registry ID, NRN or CFR	TM11039	IMO ID	
External ID	5RYX	IOTC ID	
VMS scope	Yes: national	VMS type	Inmarsat
Vessel dimensions (length/beam/draft)	24.95 / 10.16 / 3.00	Total Volume of Fish Hold(s) (m <sup>3</sup> )	0.00
Vessel master	ANDRIAMAHERY Lalaina Michel, Madagascar		
Types of gear	Unknown		
Port of registration	Toamasina, MG (MGTOA)		

Relevant Fishing authorisation(s)						
Identifier	Issued by	Valid from - Valid to	Fishing area(s)	Species	Gear	Type

Relevant Transhipment authorisation(s)		
Identifier	Issued by	Valid from - Valid to

Transhipment information									
Date	In Port / At Sea	Received/offloaded	Vessel name	Flag	ID number	Species	Product form	Catch area(s)	Quantity

Catch onboard and catch declared to be landed and/or transhipped						
Species	Product form	Catch area(s)	Quantity on board declared (Kg)	Quantity to be landed (Kg)	Quantity to be Transhipped (Kg)	
Groundfishes (GRC)	Not elsewhere identified	Madagascar	3,374	3,374	0	
Wahoo (WAH)	Not elsewhere identified	Madagascar	1,010	1,010	0	
Groundfishes (GRC)	Fillet	Madagascar	1,135	1,135	0	
Wahoo (WAH)	Fillet	Madagascar	400	400	0	
Billfish mixed (BL)	Loins	Madagascar	17	17	0	
Indo-Pacific Sailfin (SFA)	Loins	Madagascar	70	70	0	
Yellowfin tuna (YFT)	Loins	Madagascar	355	355	0	
Yellowfin tuna (YFT)	Not elsewhere identified	Madagascar	1,020	1,020	0	
Groundfishes (GRC)	Not elsewhere identified	Madagascar	405	405	0	
Octopuses (OCZ)	Not elsewhere identified	Madagascar	6,012	6,012	0	
Tropical spiny lobsters (SLV)	Not elsewhere identified	Madagascar	2,772	2,772	0	
Groundfishes (GRC)	Whole/rounded - Not processed	Madagascar	2,059	2,059	0	

## APPENDIX V:

# Data field descriptions and guide to complete the Advance Request for Entry into port (Annex I of IOTC PSMR 16/11)

Field No.	Data field	Field Description
1	Intended port of call	Record the name or code of the port where the vessel is requesting entry in free text format.  Example <i>Mombasa</i>
2	Port State	Record the name of the port State using the ISO 3166 3-alpha country/territory codes.  For example; <b>MOZ</b> (for Mozambique)
3	Estimated date and time of arrival	Record the expected date and time that the vessel will arrive at the port limits. The vessel may have to request permission or request a pilot from the port authorities to enter the port. Use: Date / Time format YYYY MM DD / HH MM Example: <b>2012 11 25 / 23 30</b>
4	Purpose(s)	Record all the reasons for the vessel requesting port access: Transshipping, Packaging, Processing of fish, Refuelling, Resupplying, Maintenance, Dry-docking.  Commonly accepted codes can be used. Example: <b>LAN</b> ; <b>TRX</b> for landing and transshipping

Field No.	Data field	Field Description
5	Port and date of last port call	Record in free text the name or the code of the last port visited by the vessel and record the date of the last port call using the date format YYYYMMDD. Example; <b>Durban 2012 07 23</b>
6	Name of the vessel	Free text: Record the full name of the vessel as registered in relevant documents of the flag State. Example: <b>Koryo Maru -11</b>
7	Flag State	Record the name of the flag State where the vessel is registered using the ISO 3166 3-alpha country/territory codes. Example: <b>NZL</b> (for New Zealand)
8	Type of vessel	Record using ISSCFV codes (also known as FAO vessel type codes). Example <b>PS</b> (for purse seine), <b>LL</b> (for long liner)
9	International Radio Call Sign	Record the "Individual radio call sign of the vessel) assigned by their national licensing authorities Example: <b>TTFC, MD66G, UDSF, CHDS</b>
10	Vessel contact information	Free text: Record the means to communicate with the vessel either directly and / or via the vessel's agent. This is essential for port State authorities to respond to the vessels request. Contact details can include; INMARSAT, fax, email, mobile phone Example: Agent - <b>Mr Adams +3482456321</b> Vessel No.s <b>Tel 81-3-5473-0513, Fax 81-3-5473-0523</b> Email <b>ujc@unitedjpn.co.jp</b>
11	Vessel owner(s)	Free text: Record the full details of the owner of the vessel together with the owners contact details. Example: Owner: <b>Wang Tat Corporation Pte Ltd,</b> Address: <b>27-4,4-chome Shinbashi, Minato-ku, Tokyo Japan</b> <b>TEL: 03-5473-0513</b> <b>FAX: 03-5473-0523</b> <b>EMAIL: ujc@unitedjpn.co.jp</b>
12	Certificate of registry ID	Record the numeric or alpha-numeric identification of the vessel's registry as issued by the flag State. Example: <b>FRA000854430</b>

## Port State measures

### Procedures for the implementation of the Indian ocean Tuna Commission

Field No.	Data field	Field Description
13	IMO ship ID, if available	Record (if available) the vessels International Maritime Organisation / Lloyds Register identification number for vessels. The IMO ship identification number is made of the three letters "IMO" followed by the seven-digit number Example: <b>IMO1234567</b>
14	External ID, if available	Record in free text Vessel Name and Port of registry; which is international practice and in most cases a national requirement. The vessel name will be displayed on the bow and the vessel name and port of registry will be displayed on the stern. Example: <b>SEIWA / Panama</b> IRCS (International Telecommunication Union Radio Call Signs); should be displayed on both port and starboard sides of vessels superstructure or side of the vessel. For vessels over 25m the height of the letters must be at least 1m and approx. 16cm thick. The lettering must be either white on a black background or black on a white background. The IRCS can be in the form of letters of the alphabet. Example: <b>JAAL</b>
14	External ID, if available (Continued)	Or where the ITU (International Telecommunication Union) assigned to a country " <i>national identifier</i> " this can be displayed in combination with a flag States licence or registration number. In this case the national identifier will be separated from the other characters by a hyphen. For example: <b>9WA-9WZ</b> (ITU allocated set of numbers allocated to <i>Malaysia</i> ) Licence or registration number assigned by the flag State. A flag State can also assign registration and licence number to identify its vessels. These can be in the form of letters of the alphabet or registration numbers and letters designated to a fishing sector. Example: <b>ST473-LT</b> (Registration number is ST473 and fishing sector line and <i>tuna</i> )
15	IOTC ID	Record the IOTC number by which the vessel is registered / authorised by IOTC For example; <b>IOTC008614</b>

Field No.	Data field	Field Description
16	VMS	Record if the vessel has a VMS fitted; Yes: National- Record if it reports to its flag State in terms of the flag State authorisation issued to the vessel Yes: RFMO(s) if the VMS information reports to the RFMO either directly or via its flag State Example: <b>NO</b> <b>YES - National</b> <b>Yes - RFMO</b>
	Type	Record in free text the type of VMS. Example: <b>INMARSAT-C</b> <b>Argos</b> <b>Euteltracs</b>
17	Vessel dimensions	Record in free text and numerically. This is standard information required to enter most ports for berthing and the vessel must provide its dimensions as stated on its registration document for. Example: <b>LOA - 54 m</b> <b>Beam- 12 m</b> <b>Draft- 6.5 m</b>
18	Vessel master name and nationality	Record in free text the name of the Master / Skipper / Captain of the vessel. (or in absentia the person onboard who has legal responsibility). The nationality of the Fishing Master according to their passport details must be recorded. <i>Note that a vessel may record the Captains details where these positions are filled by two persons.</i>
19	Relevant fishing authorisation (s)	There are two categories of fishing authorisation: → Compulsory ATF from its flag State to fish on the high seas and within the area of a RFMO. → Fishing license that the vessel may have applied for from coastal States to fish within their EEZ ( <i>Exclusive Economic Zones</i> ). Record details for each of the fishing authorisation that corresponds to the areas, catch and gear on board with respect to: identifier number, issuing authority, validity, fishing areas, species and gear. The vessel must have a valid (in-date) authorisations
	Identifier	Record the numeric or alpha-numeric identification of the authorisation to fish (fishing license / permit / authorisation). Example: (Japan) <b>Licence Number T1599</b> (Seychelles) <b>SC2011_14</b>

## Port State measures

Procedures for the implementation of the Indian ocean Tuna Commission

Field No.	Data field	Field Description
19	Issued by	Record in free text the name of the relevant authority / agency / government department from flag State or coastal State issuing the fishing license / permit / authorisation. For example: <b>Director of Fisheries Management Division, Fisheries Agency, Ministry of Agriculture Forestry and Fisheries, Government of Japan</b>
	Validity	Record the date the authorisation to fish will expire. Use date format YYYY MM DD Example: <b>2017 07 31</b>
	Fishing area(s)	Record in free text The flag State ATF provided to the vessel should state in which RFMO and FAO Statistical areas where the vessel is authorised to operate. Record in free text Example 1: <b>Atlantic Ocean / Indian Ocean / Eastern Pacific Ocean</b> Example 2: <b>Indian Ocean (FAO Areas 51 &amp; 57)</b>
		Coastal State ATF can only give permission for the vessel to operate within its EEZ. Conditions may also apply with respect to the distance it can fish from the coast or where there are fisheries exclusion zones. Example: <b>Tanzanian EEZ</b> (Not closer than 12 nautical miles from the coast).
	Species	Record the details of the fish species that each authorisation to fish lists as target species. Note these may be broadly stated as a group of species Record in free text Example; <b>Tuna &amp; Tuna-like Spp. (Excluding Bluefin Tuna)</b>
Gear	Record in free text or the ISSCFG code (also known as FAO gear codes) for the gear authorised / licensed to be used by the vessel. Example; <b>Longline or (LL)</b> Note any other gear found on board, which is not specified may be deemed IUU gear.	

Field No.	Data field	Field Description
20	Relevant transhipment authorisation (s)	Record details for each authorisation to tranship fish, corresponding to the fish that the vessel has on board, which includes: <ul style="list-style-type: none"> <li>→ identifier of each <i>authorisation</i>,</li> <li>→ details of the issuing authority, and the</li> <li>→ validity of the authorisation.</li> </ul>
	Identifier	Record the numeric or alpha-numeric identification of the transhipment license / permit / authorisation. Record transhipment unique identifier.
	Issued by	Record in free text the name of the relevant authority / agency / government department from flag State, coastal State or RFMO issuing the transhipment license / permit / authorisation. For example: <b>Tsuyoshi ONODERA, Far Seas Fisheries Division, Fisheries Agency of JAPAN</b>
	Validity	Record the start and end date during which the vessel may tranship. Format: Issued DD MM YYYY Expire DD MM YYYY.
	Transhipment information concerning donor vessels	This item of the form should be filled when the vessel requesting entry into port took onboard catches from donor vessel(s) during transhipment operations.
	Date	Record date of transhipment. Format: DD MM YYYY. Example: <b>21 10 2012</b>
21	Location	Record position (Latitude and Longitude or port) where transhipments took place Format; Position - Latitude DD MM (N or S) / Longitude DDD MM (E or W) or name of the port in free text. Example: Position; <b>05° 45' S / 067° 15' E</b> Port <b>Cape Town</b>
	Name	Record in free text the full name of donor vessel from which fish were received  Example: <b>CHIYO MARU NO.18</b>
	Flag State	Record the donor vessels flag State. Use the ISO 3166 3-alpha country/territory codes  Example: <b>MOZ</b> (for Mozambique)

## Port State measures

### Procedures for the implementation of the Indian ocean Tuna Commission

Field No.	Data field	Field Description
21	ID number	<p>Record the IOTC Identity number of the donor vessel from which fish were received. Should these vessels not be on the IOTC positive list but be reflected on another RFMO listing then record these numbers. Should the vessel not be listed by a fisheries management organisation, record their IRCS or national registration number and / or IMO number if available. The object is to be able to positively identify the vessel.</p> <p>For example: IOTC No. <b>IOTC001635</b>            ICCAT No. <b>AT000JPN00091</b>            IRCS No. <b>JAAL</b></p>
	Species	<p>Record the full list of species and products transhipped. Use FAO Species codes</p> <p>For example: <b>YFT</b> for Yellowfin tuna  <b>SKJ</b> for Skipjack tuna</p>
	Product form	<p>Record the condition or production state of the catch as offloaded from the donor vessel; either processed or not. Use FAO production codes or the "Guidelines for the reporting of fisheries statistics to the IOTC (Table 19)".</p> <p>For example: <b>NO - Unprocessed</b>  <b>DR - Dressed (gilled-and-gutted and/or headed and/or tailed and/or fins-off, etc.)</b>  <i>(Where possible cross reference the product code to its Conversion Factor. These are provided in the Species Identification section of the manual)</i></p>
	Catch area	<p>Record relevant geographical / statistical area where the catch was taken by the donor vessel. This should include as a minimum the FAO Statistical Subdivision and or Subareas.</p> <p>For example: <b>IOTC FAO 51 - EEZ MOZ or HS (high seas)</b>  <b>ICCAT FAO 47 - HS</b>  <b>CCAMLR ASD 58.4.2 - SSRU A</b></p>
	Quantity	<p>Record the total quantity of fish offloaded from each donor vessel.</p> <p>Record weights in kilograms (Kg).</p>



Field No.	Data field	Field Description
22	Total catch on board	Record the total catch / product that is onboard when the vessel will enter the port. Detail to include: Species, Product form, Catch area and Quantity.
	Species	Record a full list of the species onboard. Use FAO Species codes Example: <b>YFT</b> for Yellowfin tuna <b>BET</b> for Bigeye tuna
	Product form	See product codes for transhipment
	Catch area	See position / area recording for transhipment
	Quantity	Record the weight for each species and product. Record weights in kilograms (Kg).
23	Catch to be offloaded	Record details and quantity of the catch that will be offloaded while in port. E-PSM: record the catch to be landed and the catch to be transhipped separately.

## APPENDIX VI:

# Check List - Assessment of the Advance Request for Entry into Port

		<b>CHECK LIST</b> <b>ASSESSMENT OF ADVANCE REQUEST OF ENTRY IN PORT</b>	
Name of officer		ID	
Items/Actions	Date of Action	Potential irregularities/Comments/Results of Actions	
AREP Received	...../...../.....		
Vessel name			
Flag			
IOTC Number			
<input type="checkbox"/> 1 <sup>st</sup> port call <input type="checkbox"/> Occasional <input type="checkbox"/> Regular			
Port & date of last port call:			
Purpose of call:	<input type="checkbox"/> Landing <input type="checkbox"/> Transhipping <input type="checkbox"/> Packaging <input type="checkbox"/> Processing of fish <input type="checkbox"/> Refueling <input type="checkbox"/> Resupplying <input type="checkbox"/> Maintenance <input type="checkbox"/> Drydocking <input type="checkbox"/> Force majeure		

Verification on IUU Vessel Lists (IOTC, ICCAT, CCSBT, IATTC, WCPFC, COLTO, NAFO, OPRT, EU, NORWAY)	____/____/____	On IUU Vessel List : Y <input type="checkbox"/> N <input type="checkbox"/>
Verification on Positive Lists	____/____/____	On positive list : Y <input type="checkbox"/> N <input type="checkbox"/>
In case not on positive lists, contact with: <input type="checkbox"/> flag State <input type="checkbox"/> others _____	____/____/____	
Receipt of response	____/____/____	
Flag State Authorisation to fish	____/____/____	
In case not provided, contact with: <input type="checkbox"/> flag State <input type="checkbox"/> coastal State	____/____/____	
Transshipment Authorisation	____/____/____	
In case not provided, contact with: <input type="checkbox"/> flag State <input type="checkbox"/> others _____	____/____/____	
Receipt of response	____/____/____	
Transshipment information on donors vessels	____/____/____	
Donors vessels not on positive list, contact with: <input type="checkbox"/> flag State <input type="checkbox"/> others _____	____/____/____	
Receipt of response	____/____/____	

**Port State measures**

Procedures for the implementation of the Indian ocean Tuna Commission

<p>Request of additional information</p>	<p>Yes <input type="checkbox"/></p> <p>___/___/___</p> <p>Response received:</p> <p>___/___/___</p> <p>No <input type="checkbox"/></p>	<p><input type="checkbox"/> Coastal State authorisation to fish (specify):_____</p> <p><input type="checkbox"/> Flag State authorisation to fish</p> <p><input type="checkbox"/> Flag State authorisation to tranship</p> <p><input type="checkbox"/> Fishing logbook</p> <p><input type="checkbox"/> Certificate of registry of the fishing vessel</p> <p><input type="checkbox"/> IOTC transhipment declarations</p> <p><input type="checkbox"/> VMS record from ___/___/___ to ___/___/___</p> <p>Vessel master <input type="checkbox"/> Passport <input type="checkbox"/> National ID Card</p> <p><input type="checkbox"/> Others document: (specify):_____</p>
<p>Recommendations</p>	<p>___/___/___</p>	<p><input type="checkbox"/> Allow entry and use of facilities</p> <p><input type="checkbox"/> Allow entry but no use of port facilities</p> <p><input type="checkbox"/> Deny entry</p>
<p>If entry authorised, recommendations for inspections</p>	<p>___/___/___</p>	<p><input type="checkbox"/> Flag State authorisation to fish/TRX authorisation</p> <p><input type="checkbox"/> Flag State authorisation to tranship</p> <p><input type="checkbox"/> Fishing logbook</p> <p><input type="checkbox"/> Others document on board</p> <p><input type="checkbox"/> Fishing gear and associated equipment</p> <p><input type="checkbox"/> Others document: _____</p> <p><input type="checkbox"/> Catch on board</p> <p><input type="checkbox"/> Others: _____</p>

## APPENDIX VII:

# Notification to fishing vessel following an Advance Request for Entry into Port



### NOTIFICATION TO FISHING VESSEL FOLLOWING A REQUEST TO ENTER PORT

Date: \_\_\_\_\_

FROM:

Port State Name	
Competent authority	

TO:

Vessel representative	
-----------------------	--

#### INFORMATION ON VESSEL REQUESTING ENTRY IN PORT

AREP Received		Port of call	
Estimated date and time of arrival	_____ / _____ / _____ H_____mn		
Name of vessel		Flag of vessel	IRCS
IOTC Number		Certificate of registry ID	

## Port State measures

Procedures for the implementation of the Indian ocean Tuna Commission

### PORT STATE DECISION

The following decision has been taken with regards to the request you have submitted to enter port

- Port entry authorised
- Port entry authorised - Use of port facilities denied
- Port entry denied for the following reasons:
  - Fishing vessel on IUU Vessel List
  - Fishing vessel not authorised by flag State
  - Fishing vessel not on the positive list of the RFMO: \_\_\_\_\_
  - Other: \_\_\_\_\_

Name of officer	Date and signature	Official stamp

### Transmitted to:

- |   |  |
|---|--|
| <input type="checkbox"/> Customs:<br>-----              | <input type="checkbox"/> Flag State:<br>-----    |
| <input type="checkbox"/> Immigration:<br>-----          | <input type="checkbox"/> Coastal State:<br>----- |
| <input type="checkbox"/> Other Port Authority:<br>----- | <input type="checkbox"/> RFO/RFMO:<br>-----      |
| <input type="checkbox"/> Others:<br>-----               |  |

## APPENDIX VIII:

# Request for additional information (following AREP)



**REQUEST FOR ADDITIONAL INFORMATION  
[FOLLOWING AREP]  
(IOTC Resolution 16/11 – Paragraph 7 and 9)**

Date: \_\_\_/\_\_\_/\_\_\_\_\_

FROM:

Port State	
Competent authority	

TO:

Recipient name	
----------------	--

Possible recipients of the RAI: Flag State, Coastal State, Port State, Agent, Beneficial owner, Owner, Operator, Master, Fishing Master, Secretariat of RFMO, CPCs.

INFORMATION ON VESSEL REQUESTING ENTRY IN PORT			
AREP Received		Port of call	
Estimated date and time of arrival	_____ / _____ / _____ H_____mn		
Name of vessel		Flag of vessel	IRCS
RFMO number		Certificate of registry ID	

## Port State measures

### Procedures for the implementation of the Indian ocean Tuna Commission

#### REQUEST FOR ADDITIONAL INFORMATION

You are requested to provide the following documents as complementary information of your request to enter the port.

Coastal State fishing license to fish (specify): \_\_\_\_\_  
\_\_\_\_\_

Flag State authorisation to fish  Flag State authorisation to tranship

Fishing logbook from \_\_\_/\_\_\_/\_\_\_\_\_ to \_\_\_/\_\_\_/\_\_\_\_\_

Certificate of registry of the vessel

Transhipment declarations

VMS record from \_\_\_/\_\_\_/\_\_\_\_\_ to \_\_\_/\_\_\_/\_\_\_\_\_

Passport  National ID Card of the vessel master

Others document: (specify): \_\_\_\_\_  
\_\_\_\_\_

Confirmation is requested that all fish on board the vessel was taken in accordance with all applicable requirements of a relevant regional fisheries management organisation (RFMO): \_\_\_\_\_, including the IOTC. To confirm that the fish on board was taken in accordance with applicable requirements of the RFMO, all information/ documents indicated below must be received within \_\_\_\_\_ working days of the issuance of this request. If confirmation is not received within indicated working days, the vessel will be denied use of port for landing, transhipping, packaging, processing, refuelling, resupplying, maintenance and drydocking in accordance with paragraph 9.1 (d) of IOTC Resolution 16/11

Name of officer	Date and signature	Official stamp

#### Transmitted to:

Customs:  
\_\_\_\_\_

Immigration:  
\_\_\_\_\_

Port Authority:  
\_\_\_\_\_

Others:  
\_\_\_\_\_

Flag State:  
\_\_\_\_\_

Coastal State:  
\_\_\_\_\_

RFO/RFMO:  
\_\_\_\_\_



**37. Findings by inspector(s)****38. Apparent infringement(s) noted including reference to relevant legal instrument(s)****39. Comments by the master****40. Action taken**

DATE AND SIGNATURE  
OF THE FISHERIES  
INSPECTOR(S)

DATE AND  
SIGNATURE OF  
THE CAPTAIN

## Port State measures

### Procedures for the implementation of the Indian ocean Tuna Commission

Field No.	Data Field Description	Field Information
1.	Inspection report No	Serial number of the report: [Country code]/[Port Code]/[0001]/[Year]. Example: MOZ/BEW/0001/2013.
2	Port State	Name or code of the port State.
3	Inspecting authority	Name of the port State authority/agency/government department deploying the inspector(s).
4	Name and ID of principal inspector	Name of the inspector if alone, or the inspector leading (senior) the inspection team. ID - the identification number (card) of the inspector should be added.
5	Port of inspection	Name or code of the port where the inspection takes place.
6	Commencement of inspection	Date and hour the inspection procedure started (date format: YYYYMMDD, and hour format HH).
7	Completion of inspection	Date and hour the inspection procedure ended. (date format: YYYYMMDD and hour format HH).
8	Advance notification received	Was advanced notice to enter port received; Y <input type="checkbox"/> N <input type="checkbox"/>
9	Purpose(s)	What are the purpose(s) for entering port? Include one or several of those categories below: Landing, Transhipping, Packaging, Processing, Refuelling, Resupplying, Maintenance, Drydocking, Others
10	Last port call Port name State Date	Free text. Name or code of the port the vessel last entered. ISO 3166 3-alpha country/territory codes. Example: MOZ = Mozambique. Date format: YYYYMMDD
11	Vessel name	Free text. Name of the vessel as registered in relevant flag State documents.
12	Flag State	ISO 3166 3-alpha country/territory codes Example: NZL for New Zealand.
13	Type of vessel	International Standard Statistical Classification of Fishery Vessels (ISSCFV) codes, also known as FAO vessel type codes Example:, TO = trawler, LL = longliner.

Field No.	Data Field Description	Field Information
14	IRCS	Vessel's international radio call sign (IRCS) Example: TTFC, MD66G, UDSF, CHDS.
15	Certificate of Registry ID	Numeric or alphanumeric identification of the vessel's registry as issued by the flag State.
16	IMO ship ID	IMO/Lloyds Register identification number for vessels. "IMO" followed by the seven-digit number. Example: <b>IMO1234567</b>
17	External ID	Record in free text <u>Vessel Name and Port of registry:</u> For example: <b>SEIWA Panama</b> <u>IRCS</u> (International Telecommunication Union Radio Call Signs); IRCS can be in the form of letters of the alphabet. For example: <b>JAAL</b> <u>National Identifier</u> this can be displayed in combination with a flag State's licence or registration number. For example: <b>9WA-9WZ</b> (ITU allocated set of numbers allocated to Malaysia) <u>Licence or registration number assigned by the flag State.</u> For example: <b>ST473-LT</b>
18	Port of Registry	Free text. Name or code of the port where the vessel is registered.
19	Name, address & contact of the vessel owner(s)	Free text. Name of individual(s) or company(ies) that own the vessel.
20	Name, address & contact of the beneficial owner(s) (if different from vessel owner)	Free text. Name of individual owner(s) controlling financially the owner company(ies), or holding company effectively controlling the ownership of the vessel.
21	Name, address & contact of the operator(s) (if different from vessel owner)	Free text. Name of individual(s) or company(ies) controlling the operational decisions of the vessel's activity.

**Port State measures**

Procedures for the implementation of the Indian ocean Tuna Commission

**APPENDIX IX:**

Port inspection report form (IOTC PSMR Annex III) and guide for completion

	<b>PORT INSPECTION REPORT FORM</b>	1. Inspection report no	2. Port State

3. Inspecting authority							
4. Name and ID of principal inspector				5. Port of inspection			
6. Commencement of inspection			7. Completion of inspection				
Y	M	D	HH	Y	M	D	HH
8. Advance notification received		9. Purpose(s) (√)	<input type="checkbox"/> Landing <input type="checkbox"/> Transhipping <input type="checkbox"/> Packaging <input type="checkbox"/> Processing <input type="checkbox"/> Refueling <input type="checkbox"/> Resupplying <input type="checkbox"/> Maintenance <input type="checkbox"/> Drydocking <input type="checkbox"/> Others				
Y <input type="checkbox"/> N <input type="checkbox"/>							
10. Last port call		Port name		State		Date	
						Y <input type="checkbox"/> M <input type="checkbox"/> D <input type="checkbox"/>	
11. Vessel name			12. Flag State			13. Type of vessel	

14. IRCS	15. Certificate of Registry ID	16. IMO ship ID	17. External ID	18. Port of Registry	
19. Name, address & contact of the vessel owner(s)		20. Name, address & contact of the beneficial owner(s) (if different from vessel owner)		21. Name, address & contact of the operator(s) (if different from vessel owner)	
22. Vessel master name and nationality		23. Fishing master name and nationality		24. Vessel agent	
25. VMS	N <input type="checkbox"/> Y National <input type="checkbox"/> Y RFMOs <input type="checkbox"/>	Type:	<input type="checkbox"/> Argos <input type="checkbox"/> Inmarsat <input type="checkbox"/> Iridium <input type="checkbox"/> Others :		
26. Status in IOTC, including any IUU vessel listing					
Vessel identifier	RFMO	Flag State status	Vessel on authorised list	Vessel on IUU Vessel List	
			Y <input type="checkbox"/> N <input type="checkbox"/> <input type="checkbox"/>	Y <input type="checkbox"/> N <input type="checkbox"/> <input type="checkbox"/>	
27. Relevant fishing authorisation(s)					
Vessel identifier	Issued by	Validity	Fishing area(s)	Species	Gear
28. Relevant transshipment authorisation(s)					
Vessel identifier	Issued by		Validity		

## Port State measures

### Procedures for the implementation of the Indian ocean Tuna Commission

#### 29. Transhipment information concerning donor vessels

Vessel name	Flag State	ID no	Species	Product form	Catch area(s)	Quantity

#### 30. Evaluation of offloaded catch (quantity)

Species	Product form	Catch area(s)	Quantity declared	Quantity offloaded	Difference between quantity declared and quantity determined

#### 31. Catch retained onboard (quantity)

Species	Product form	Catch area(s)	Quantity declared	Quantity retained	Difference between quantity declared and quantity determined

#### 32. Examination of logbook(s) and other documentation

Y  N

Comments

#### 33. Compliance with applicable catch documentation scheme(s)

Y  N

Comments

#### 34. Compliance with applicable trade information scheme(s)

Y  N

Comments

#### 35. Type of gear used

#### 36. Gear examined in accordance with paragraph e) of Annex 2

Y  N

Comments

**37. Findings by inspector(s)****38. Apparent infringement(s) noted including reference to relevant legal instrument(s)****39. Comments by the master****40. Action taken**

DATE AND SIGNATURE  
OF THE FISHERIES  
INSPECTOR(S)

DATE AND  
SIGNATURE OF  
THE CAPTAIN

## Port State measures

Procedures for the implementation of the Indian ocean Tuna Commission

Field No.	Data Field Description	Field Information
1.	Inspection report No	Serial number of the report: [Country code]/[Port Code]/[0001]/[Year]. Example: MOZ/BEW/0001/2013.
2	Port State	Name or code of the port State.
3	Inspecting authority	Name of the port State authority/agency/government department deploying the inspector(s).
4	Name and ID of principal inspector	Name of the inspector if alone, or the inspector leading (senior) the inspection team. ID - the identification number (card) of the inspector should be added.
5	Port of inspection	Name or code of the port where the inspection takes place.
6	Commencement of inspection	Date and hour the inspection procedure started (date format: YYYYMMDD, and hour format HH).
7	Completion of inspection	Date and hour the inspection procedure ended. (date format: YYYYMMDD and hour format HH).
8	Advance notification received	Was advanced notice to enter port received; Y <input type="checkbox"/> N <input type="checkbox"/>
9	Purpose(s)	What are the purpose(s) for entering port? Include one or several of those categories below: Landing, Transhipping, Packaging, Processing, Refuelling, Resupplying, Maintenance, Drydocking, Others
10	Last port call Port name State Date	Free text. Name or code of the port the vessel last entered. ISO 3166 3-alpha country/territory codes. Example: MOZ = Mozambique. Date format: YYYYMMDD
11	Vessel name	Free text. Name of the vessel as registered in relevant flag State documents.
12	Flag State	ISO 3166 3-alpha country/territory codes Example: NZL for New Zealand.
13	Type of vessel	International Standard Statistical Classification of Fishery Vessels (ISSCFV) codes, also known as FAO vessel type codes Example:, TO = trawler, LL = longliner.



Field No.	Data Field Description	Field Information
14	IRCS	Vessel's international radio call sign (IRCS) Example: TTFC, MD66G, UDSF, CHDS.
15	Certificate of Registry ID	Numeric or alphanumeric identification of the vessel's registry as issued by the flag State.
16	IMO ship ID	IMO/Lloyds Register identification number for vessels. "IMO" followed by the seven-digit number. Example: <b>IMO1234567</b>
17	External ID	Record in free text <u>Vessel Name and Port of registry:</u> For example: <b>SEIWA Panama</b> <u>IRCS</u> (International Telecommunication Union Radio Call Signs); IRCS can be in the form of letters of the alphabet. For example: <b>JAAL</b> <u>National Identifier</u> this can be displayed in combination with a flag State's licence or registration number. For example: <b>9WA-9WZ</b> (ITU allocated set of numbers allocated to Malaysia) <u>Licence or registration number assigned by the flag State.</u> For example: <b>ST473-LT</b>
18	Port of Registry	Free text. Name or code of the port where the vessel is registered.
19	Name, address & contact of the vessel owner(s)	Free text. Name of individual(s) or company(ies) that own the vessel.
20	Name, address & contact of the beneficial owner(s) (if different from vessel owner)	Free text. Name of individual owner(s) controlling financially the owner company(ies), or holding company effectively controlling the ownership of the vessel.
21	Name, address & contact of the operator(s) (if different from vessel owner)	Free text. Name of individual(s) or company(ies) controlling the operational decisions of the vessel's activity.

## Port State measures

### Procedures for the implementation of the Indian ocean Tuna Commission

Field No.	Data Field Description	Field Information
22	Vessel master name and nationality	Free text. Name of vessel's master/skipper/captain (or person with legal responsibility onboard).
23	Fishing master name and nationality	Free text. Name of the person responsible for the fisheries operations, if different from the master.
24	Vessel agent	Free text. Name of individual(s) or company(ies) representing vessel's interests, based in the port State or not. Such representation may or may not include legal accountability or liability.
25	VMS	<p>Answer <b>"No"</b> if the vessel has no vessel monitoring system (VMS) equipment installed on board</p> <p>Answer <b>"Yes: National"</b> if VMS equipment is installed on board under vessel's flag State requirements;</p> <p>Answer <b>"Yes: RFMOs"</b> if VMS equipment is installed on board under RFMO requirements.</p>
26	Status in IOTC, including any IUU vessel listing	<p>Should be filled if the vessel was operated in the area of competence of any RFMO.</p> <ul style="list-style-type: none"> <li>→ <u>Vessel identifier</u> - Numeric or alphanumeric identification of the vessel issued by RFMO if available.</li> <li>→ <u>RFMO</u> Free text. Name of the RFMO(s).</li> <li>→ <u>Flag State status</u>- Free text. Membership status of the vessel's flag State in the RFMO(s). <b>"CP"</b> for Contracting Party, <b>"Coop NCP"</b> for Cooperative Non-Contracting Party or <b>"NCP"</b> for Non-Contracting Party.</li> <li>→ <u>Vessel on authorised list</u> - Is the vessel on an authorised vessel list issued by the RFMO(s) to operate in its area of competence? Yes or No.</li> <li>→ <u>Vessel on IUU Vessel List</u> - Is the vessel on an IUU vessel list issued by the RFMO(s)? <b>Yes or No.</b></li> </ul>

Field No.	Data Field Description	Field Information
27	<p>Relevant fishing authorisation(s)</p> <ul style="list-style-type: none"> <li>→ <i>Vessel identifier</i></li> <li>→ <i>Issued by</i></li> <li>→ <i>Validity Fishing area(s)</i></li> <li>→ <i>Species</i></li> <li>→ <i>Gear</i></li> </ul>	<ul style="list-style-type: none"> <li>→ <u>Vessel Identifier</u> - Numeric or alphanumeric identification of the fishing license/permit/authorisation.</li> <li>→ <u>Issued by</u> - Name of the relevant authority/agency/ government department from flag State, coastal State and/or RFMO issuing the fishing license/permit/ authorisation.</li> <li>→ <u>Validity</u> - Date by which the fishing license/permit/ authorisation will expire (date format: YYYYMMDD).</li> <li>→ <u>Fishing area(s)</u> - Relevant geographical/statistical area where the vessel is authorised to operate (e.g. FAO 77, NAFO 3M, ICES 11b).</li> <li>→ <u>Species</u> - ASFIS 3-alpha codes (also known as FAO species codes) (e.g., WHB for blue whiting, SKA for skates, WRF for wreckfish).</li> <li>→ <u>Gear</u> - ISSCFG code (also known as FAO gear codes) for the gear authorised/licensed to be used by the vessel (e.g. OTB for bottom otter trawl).</li> </ul>
28	<p>Relevant transshipment authorisation(s)</p> <ul style="list-style-type: none"> <li>→ <i>Vessel identifier</i></li> <li>→ <i>Issued by</i></li> <li>→ <i>Validity</i></li> </ul>	<ul style="list-style-type: none"> <li>→ <u>Identifier</u> - Numeric or alphanumeric identification of the transshipment license/permit/authorisation.</li> <li>→ <u>Issued by</u> - Name of the relevant authority/agency/ government department from flag State, coastal State or RFMO issuing the transshipment license/permit/ authorisation.</li> <li>→ <u>Validity</u> - Date by which the transshipment license / permit / authorisation will expire. Date format YYYYMMDD.</li> </ul>

## Port State measures

Procedures for the implementation of the Indian ocean Tuna Commission

Field No.	Data Field Description	Field Information
29	<p>Transhipment information concerning donor vessels</p> <ul style="list-style-type: none"> <li>→ <i>Vessel name</i></li> <li>→ <i>Flag State</i></li> <li>→ <i>ID no</i></li> <li>→ <i>Species</i></li> <li>→ <i>Product form</i></li> <li>→ <i>Catch area(s)</i></li> <li>→ <i>Quantity</i></li> </ul>	<p>This portion of the report should be filled in if the vessel unloaded catch from donor vessel(s) during transhipment operations.</p> <ul style="list-style-type: none"> <li>→ <u>Vessel Name</u> - Free text. Name of the donor vessel.</li> <li>→ <u>Flag State</u> - ISO 3166 3-alpha country/territory code of the donor vessel's flag State.</li> <li>→ <u>ID number</u> - Identification of the donor vessel (IRCS or IMO number).</li> <li>→ <u>Species</u> - ASFIS 3-alpha codes (also known as FAO species codes) for the species offloaded by the donor vessel.</li> <li>→ <u>Product form</u> - Condition of the catch as offloaded from the donor vessel, either processed or not (e.g., whole frozen; headed and gutted, tail off refrigerated).</li> <li>→ <u>Catch area</u> - Relevant geographical/statistical area where the catch was taken by the donor vessel (e.g., US GOA 630, CCAMLR 48.6).</li> <li>→ <u>Quantity</u> - Quantity of offloaded catch from the donor vessel, in MT or kg. If other units are used, they should be clearly identified.</li> </ul>
30	<p>Evaluation of offloaded catch (quantity)</p> <ul style="list-style-type: none"> <li>→ <i>Species</i></li> <li>→ <i>Product form</i></li> <li>→ <i>Catch area(s)</i></li> <li>→ <i>Quantity declared</i></li> <li>→ <i>Quantity offloaded</i></li> <li>→ <i>Difference between quantity declared and quantity determined</i></li> </ul>	<ul style="list-style-type: none"> <li>→ <u>Species</u> - ASFIS 3-alpha codes (also known as FAO species codes) for all species offloaded.</li> <li>→ <u>Product form</u> - Condition of the offloaded catch, either processed or not (e.g., skinless, boneless fillets frozen; head off, split salted; whole refrigerated in seawater).</li> <li>→ <u>Catch area(s)</u> - Relevant geographical area where offloaded catch was taken.</li> <li>→ <u>Quantity declared</u> - Quantity of offloaded catch as declared by the master in the Advance Notification in MT or kg. If other units are used, they should be clearly identified.</li> <li>→ <u>Quantity offloaded</u> - Quantity of effectively offloaded catch as determined by inspectors, in MT or kg. If other units are used, they should be clearly identified.</li> <li>→ <u>Difference between quantity declared and quantity determined</u>, if any in kg. If other units are used, they should be clearly identified.</li> </ul>

Field No.	Data Field Description	Field Information
31	<p>Catch retained onboard (quantity)</p> <p>→ <i>Species</i></p> <p>→ <i>Product form</i></p> <p>→ <i>Catch area(s)</i></p> <p>→ <i>Quantity declared</i></p> <p>→ <i>Quantity offloaded</i></p> <p>→ <i>Difference between quantity declared and quantity determined</i></p>	<p>→ Species - ASFIS 3-alpha codes (also known as FAO species codes) for all species offloaded.</p> <p>→ Product form - Condition of the offloaded catch, either processed or not (See product form for field 30).</p> <p>→ Catch area(s) - Relevant geographical area where offloaded catch was taken.</p> <p>→ Quantity declared - Quantity of offloaded catch as declared by the master in the Advance Notification in MT or kg. If other units are used, they should be clearly identified.</p> <p>→ Quantity offloaded - Quantity of effectively offloaded catch as determined by inspectors, in MT or kg. If other units are used, they should be clearly identified.</p> <p>→ Difference between quantity declared and quantity determined, if any in kg.</p>
32	Examination of logbook(s) and other documentation	<p><b>Yes or No</b>, depending on whether the logbooks were examined.</p> <p>Free text for comments by the inspector(s).</p>
33	Compliance with applicable catch documentation scheme(s)	<p><b>Yes or No</b>, depending on whether the vessel's is compliant with relevant catch documentation schemes.</p> <p>Free text for comments by the inspector(s).</p>
34	Compliance with applicable trade information scheme(s)	<p><b>Yes or No</b>, depending on whether the vessel is compliant with relevant catch documentation schemes.</p> <p>Free text for comments by the inspector(s).</p>
35	Type of gear used	<p>Free text. Name (or description) of gear found onboard by the inspector(s).</p> <p>ISSCFG code (also known as FAO gear codes) may be used.</p>
36	Gear examined in accordance with paragraph e) of Annex 2	<p><b>Yes or no</b> depending on whether the inspector(s) examined gear(s) following the procedure established in Annex B.</p> <p>Free text for comments by the inspector(s).</p>
37	Findings by inspector(s)	Free text. Description of all relevant facts and findings as determined by the inspector(s) during the inspection.

## Port State measures

Procedures for the implementation of the Indian ocean Tuna Commission

Field No.	Data Field Description	Field Information
38	Apparent infringement(s) noted including reference to relevant legal instrument(s)	Free text. Description of violation(s) found as perceived by inspector(s). Clear mention of the relevant legal instrument (e.g., Article 19 d) of the NEAFC Scheme of Control and Enforcement.
39	Comments by the master	Free text. Any comments by the master regarding the development of the inspection, the inspectors' findings or the infringements alleged.
40	Action taken	Free text. Description by the inspector(s) of all action taken as a follow-up to the inspection (e.g., catch apprehension, gear retention, legal prosecution, fine imposed).
	Date and signature of the fisheries inspector(s)	
	Date and signature of the captain	By signing the report, the master acknowledges only receipt of his report copy. Such signature does not represent in any way an acceptance of guilt when apparent infringements were detected by inspector(s).

## APPENDIX X:

# Port inspection report form for IOTC CMM requirements

### Compliance with IOTC Conservation and Management Measures

Fishing logbook(s)		Resolution 19/04	
Fishing national logbook is onboard with consecutively numbered pages	Y <input type="checkbox"/> N <input type="checkbox"/>	Original recording of fishing logbook is onboard for the last 12 months	Y <input type="checkbox"/> N <input type="checkbox"/>
Has been filled by the captain / set	Y <input type="checkbox"/> N <input type="checkbox"/>	Includes information on <input type="checkbox"/> Vessel <input type="checkbox"/> trip <input type="checkbox"/> gear configuration <input type="checkbox"/> vessel operation & catch	Fishing logbook is bound Y <input type="checkbox"/> N <input type="checkbox"/>
Logbook data was provided by the fishing master to the flag State administration Y <input type="checkbox"/> N <input type="checkbox"/> and to the coastal State administration Y <input type="checkbox"/> N <input type="checkbox"/> (where the vessel has fished in that coastal State's waters)			
Longliners		Resolution 15/01	
Logbook contains the primary species	SBF <input type="checkbox"/> ALB <input type="checkbox"/> BET <input type="checkbox"/> YFT <input type="checkbox"/> SKJ <input type="checkbox"/> SWO <input type="checkbox"/> BUM <input type="checkbox"/> BLM <input type="checkbox"/> SFA <input type="checkbox"/> MLS <input type="checkbox"/>		
Catch recorded in number & weight / species / set & form of processing	Y <input type="checkbox"/> N <input type="checkbox"/>	Discard of tuna, tuna-like fish, sharks recorded in remarks	Y <input type="checkbox"/> N <input type="checkbox"/>
Purse seiner		Resolution 15/01	
Logbook contains the primary species	ALB <input type="checkbox"/> BET <input type="checkbox"/> YFT <input type="checkbox"/> SKJ <input type="checkbox"/>	The type of association is recorded	Y <input type="checkbox"/> N <input type="checkbox"/>
Deployment of FAD is recorded	Y <input type="checkbox"/> N <input type="checkbox"/>	Catch is recorded in weight / species / set & form of processing	Y <input type="checkbox"/> N <input type="checkbox"/>
		Discard of tuna, tuna-like fish, sharks recorded in remarks	Y <input type="checkbox"/> N <input type="checkbox"/>

## Port State measures

### Procedures for the implementation of the Indian ocean Tuna Commission

<b>Gillnet</b>		<b>Resolution 15-01</b>	
Logbook contains the primary species	SBF <input type="checkbox"/> ALB <input type="checkbox"/> BET <input type="checkbox"/> YFT <input type="checkbox"/> SKJ <input type="checkbox"/> LOT <input type="checkbox"/> FRI <input type="checkbox"/> KAW <input type="checkbox"/> COM <input type="checkbox"/> GUT <input type="checkbox"/> SWO <input type="checkbox"/> SFA <input type="checkbox"/> BIL <input type="checkbox"/>		
Catch is recorded in weight / species / set & form of processing	Y <input type="checkbox"/> N <input type="checkbox"/>	Discard of tuna, tuna-like fish, sharks recorded in remarks	Y <input type="checkbox"/> N <input type="checkbox"/>

<b>Pole and line</b>		<b>Resolution 15-01</b>	
Logbook contains the primary species	SBF <input type="checkbox"/> ALB <input type="checkbox"/> BET <input type="checkbox"/> YFT <input type="checkbox"/> SKJ <input type="checkbox"/> FRZ <input type="checkbox"/> KAW <input type="checkbox"/> COM <input type="checkbox"/> LOT <input type="checkbox"/>		
Catch recorded in number & weight / species / set & form of processing	Y <input type="checkbox"/> N <input type="checkbox"/>	Discard of tuna, tuna-like fish, sharks recorded in remarks	Y <input type="checkbox"/> N <input type="checkbox"/>

<b>Documents onboard</b>		<b>Resolution 19/04</b>	
Authorisation to fish and/ or tranship on board	Y <input type="checkbox"/> N <input type="checkbox"/>	Issued by competent authority: Y <input type="checkbox"/> N <input type="checkbox"/>	Name of competent authority
Valid certificate of registration onboard	Y <input type="checkbox"/> N <input type="checkbox"/>	Issued by competent authority: Y <input type="checkbox"/> N <input type="checkbox"/>	Name of competent authority
Documents show	Vessel name <input type="checkbox"/> Port & registration number <input type="checkbox"/> IRCS <input type="checkbox"/> Name/addresses of owner <input type="checkbox"/> Length of vessel <input type="checkbox"/>		
	Name & addresses of charter where relevant <input type="checkbox"/> Engine power <input type="checkbox"/>		

<b>Marking of fishing gears (Longliners)</b>		<b>Resolution 19/04</b>	
Fishing gear marked at day with flag and radar reflector	Y <input type="checkbox"/> N <input type="checkbox"/>	Fishing gear marked at night with light buoys	Y <input type="checkbox"/> N <input type="checkbox"/>
		Buoys marked with letter/number of vessel identification	Y <input type="checkbox"/> N <input type="checkbox"/>

<b>Driftnets (All vessels)</b>		<b>Resolution 17/07 To prohibit the use of large-scale driftnets on the high seas in the IOTC area</b>	
The vessel is found operating on the high seas in the IOTC Area and is configured to use large-scale driftnets	Y <input type="checkbox"/> N <input type="checkbox"/>	Position of the vessel:	
The driftnets and related fishing equipment are stowed / secured in such a manner that they are not readily available to be used for fishing	Y <input type="checkbox"/> N <input type="checkbox"/>		

<b>Marking of FADs (Purse Seiner)</b>		<b>Resolution 19/04</b>	
Does the vessel carry FADs?	Y <input type="checkbox"/> N <input type="checkbox"/>	Are all FADs marked with letter/number of vessel identification	Y <input type="checkbox"/> N <input type="checkbox"/>



Marking of fishing vessel		Resolution 19/04	
Identification marks on the fishing vessel	<input type="checkbox"/> National registration number <input type="checkbox"/> Fishing licence <input type="checkbox"/> IRCS <input type="checkbox"/> Vessel name <input type="checkbox"/> Port of registration		
	<input type="checkbox"/> Other mark (specify):		
Type of marking	Marking on vessel	Same as IOTC Record	
Vessel name		Stern	Y <input type="checkbox"/> N <input type="checkbox"/>
		Port Side	Y <input type="checkbox"/> N <input type="checkbox"/>
National registration number		Starboard Side	Y <input type="checkbox"/> N <input type="checkbox"/>
		Port Side	Y <input type="checkbox"/> N <input type="checkbox"/>
IRCS		Starboard Side	Y <input type="checkbox"/> N <input type="checkbox"/>
		Port Side	Y <input type="checkbox"/> N <input type="checkbox"/>
Other mark (specify):		Starboard Side	Y <input type="checkbox"/> N <input type="checkbox"/>
		Stern	Y <input type="checkbox"/> N <input type="checkbox"/>
		Port Side	Y <input type="checkbox"/> N <input type="checkbox"/>
		Starboard Side	Y <input type="checkbox"/> N <input type="checkbox"/>

Vessel Monitoring System				Resolution 15/03	
VMS device is installed onboard the fishing vessel	Y <input type="checkbox"/> N <input type="checkbox"/>	The positions of the FV are received by the national FMC	Y <input type="checkbox"/> N <input type="checkbox"/>	The device is located in a sealed unit and protected by official seals	Y <input type="checkbox"/> N <input type="checkbox"/>
The antennae connected to the satellite monitoring device(s) are not obstructed	Y <input type="checkbox"/> N <input type="checkbox"/>	The power supply of the satellite monitoring device(s) is not interrupted	Y <input type="checkbox"/> N <input type="checkbox"/>		
Vessel monitoring device(s) are not removed from the vessel	Y <input type="checkbox"/> N <input type="checkbox"/>	Any technical failure has been communicated to the flag State and/or the Secretariat	Y <input type="checkbox"/> N <input type="checkbox"/>	Date:	
If technical failure, the vessel has communicated to the FMC of the flag State the vessel identification, the date & positions every 4 hours by email, facsimile, telex, telephone message or radio.	Y <input type="checkbox"/> N <input type="checkbox"/>		By email <input type="checkbox"/> facsimile <input type="checkbox"/> telex <input type="checkbox"/> telephone message <input type="checkbox"/> radio <input type="checkbox"/>		
If technical failure, the device was repaired or replaced within one month	Y <input type="checkbox"/> N <input type="checkbox"/>	Date of repair:			

## Port State measures

### Procedures for the implementation of the Indian ocean Tuna Commission

#### Marine Turtles (all vessels) Resolution 12/04

The logbook contains information on incidental catches of marine turtles (details on species, location of capture, conditions, actions taken on board and location of release)						Y <input type="checkbox"/>	N <input type="checkbox"/>
The vessel carries line cutters	Y <input type="checkbox"/> N <input type="checkbox"/>	The vessel carries de-hookers	Y <input type="checkbox"/> N <input type="checkbox"/>	The vessel is using whole finfish bait	Y <input type="checkbox"/> N <input type="checkbox"/>	The vessel carries dip-nets	Y <input type="checkbox"/> N <input type="checkbox"/>

#### Sharks fins (all vessels) Resolution 17/05

Shark on board are fully utilised (carcass and fins present on board)	Y <input type="checkbox"/> N <input type="checkbox"/>	Shark fresh: Fins are not attached to the body	Y <input type="checkbox"/> N <input type="checkbox"/>	Weight of shark (kg):	Weight of fins (kg):
		Shark frozen: Fins onboard total not more than 5 percent of the weight of sharks onboard	Y <input type="checkbox"/> N <input type="checkbox"/>	Weight of shark (kg):	Weight of fins (kg):

#### Billfish Striped marlin, black marlin, blue marlin, Indo-Pacific sailfish) (all vessels) Resolution 18/05

The fishing vessel has billfish smaller than 60 cm Lower Jaw Fork Length on board	Y <input type="checkbox"/> N <input type="checkbox"/>	Weight (kg)	Specie		Specie		Specie	
---	--	-------------	--------	--	--------	--	--------	--

#### Thresher sharks (all vessels) Resolution 12/09

The fishing vessel has thresher sharks of the family Alopiidae on board	Y <input type="checkbox"/> N <input type="checkbox"/>	Weight (kg)	PTH		BTH		ALV	
---	--	-------------	-----	--	-----	--	-----	--

#### Oceanic whitetip sharks (all vessels) Resolution 13/06

The fishing vessel has oceanic whitetip sharks on board	Y <input type="checkbox"/> N <input type="checkbox"/>	Weight (kg)		Number	
---	--	-------------	--	--------	--

#### Mobulid ray (all vessels) Resolution 19/03

The fishing vessel has mobulid rays on board	Y <input type="checkbox"/> N <input type="checkbox"/>	Weight (kg)		Number	
--	--	-------------	--	--------	--

Cetaceans (Purse Seiner)			Resolution 13/04
The FV has intentionally set a purse seine around a cetacean	Y <input type="checkbox"/> N <input type="checkbox"/>	Date	Position of the vessel:  
Whale sharks (Purse Seiner)			Resolution 13/05
The FV has intentionally set a purse seine around a whale shark	Y <input type="checkbox"/> N <input type="checkbox"/>	Date	Position of the vessel:  
Sea birds (Longliners)			Resolution 12/06
For vessels fishing south of 25°S the longline vessel use at least two mitigation measures	<input type="checkbox"/> Night setting with minimum deck lighting <input type="checkbox"/> Bird-scaring lines (Tori Lines) <input type="checkbox"/> Weighted branch lines		
Conformity of mitigation measures to the minimum technical standards			(Annex 1 of Resolution 12/06)
The vessel has not set line between nautical dawn & before nautical dusk. The deck was lighted at a minimum	Y <input type="checkbox"/> N <input type="checkbox"/>	Bird-scaring line was deployed during longline setting to deter birds from approaching branch line	Y <input type="checkbox"/> N <input type="checkbox"/>
Data buoys (All vessels)			Resolution 11/02
The FV has fished intentionally within 1 nautical mile of or interacted with a data buoy	Y <input type="checkbox"/> N <input type="checkbox"/>	Date(s) and position(s) of the vessel:  	
The FV has taken on board a data buoy while engaged in fishing in the IOTC Area of competence	Y <input type="checkbox"/> N <input type="checkbox"/>	Date(s) and position(s) of the vessel:  	

## APPENDIX XI:

# Offloading Monitoring Form and guide for completion

	<b>OFFLOADING MONITORING FORM A</b>	1. Inspection report No.	2. Port State

### General information

3. Inspector Name and ID		4. Inspecting Authority		5. Port of inspection	
6. Vessel Name		7. Vessel Type			
8. IOTC Number		9. IRCS			
10. Documents Received (✓)	<input type="checkbox"/> Hold layout plan <input type="checkbox"/> Cargo manifest <input type="checkbox"/> Catch Declaration <input type="checkbox"/> Offloading Declaration				

### Summary of operations

	Commencement		Completion		13. Total interruption time (hr)
	Date	Time	Date	Time	
11. Operation					
12. Observed					
14. Percentage offloading monitored (Total Hours Offloaded divided by Hours Monitored)					



## Port State measures

Procedures for the implementation of the Indian ocean Tuna Commission

Field No.	<b>OFFLOADING MONITORING FORM A - Field Descriptions</b>	
<p>The offloading FORM A is designed to record a comprehensive summary of the recorded information for the entire offloading or transhipment operation. It includes the totals of all the species and quantities recorded in FORM B.</p>		
1	Inspection report no.	Depending on the fisheries authority administrative processes and information filing; each inspection should be allocated a unique “ <i>Inspection report number</i> ” that will facilitate filing and future referencing.
2	Port State	Record the ISO-3166 3-alpha Country Code. (Reference Appendix XIII)
<b>General information</b>		
3	Inspector Name and ID	Record the inspector(s) name(s) that monitor the offloading or transhipment process.
4	Inspecting Authority	Record the full formal details of the Inspecting Authority
5	Port of inspection	Record in free text the port name and include the port code where available.
6	Vessel Name	Record the vessels name in full, including any alpha or numeric suffixes. <i>For example; Fukuseki Maru No.7</i>
7	Vessel Type	Record the fishing vessel code (FAO-3alpha code). (Reference Appendix XIII) <i>For example; LP (for a pole and line vessel)</i>
8	IOTC No.	Record the vessels IOTC number
9	IRCS	Record the vessels International Radio Call Sign.

10	Documents received	Tick the corresponding box for all documents received from the vessel prior to the off-loading.
	→ Hold layout plan	Plan of the hold showing where the product is stowed. This may also correspond to different catch areas and ATFs that have been issued to the vessel.  Carrier Vessels often separate the product received from different vessels or companies with a net and this is reflected in the hold plan with reference to the origin of the fish.
	→ Cargo manifest	A carrier vessel should be able to provide a cargo manifest that lists all the product it has onboard and the component that it will offload. The cargo manifest will provide details of the origin of the product as well as its intended destination.
	→ Catch Declarations	Fishing vessels must provide documentation on their total catch onboard.
	→ Offloading Declaration	The offloading declaration should provide advances information on the catch description / species and products to be offloaded or transhipped. Such a declaration will be applicable to both a carrier and fishing vessel.  A final declaration for the product offloaded or transhipped will be drawn up after the operation.
<b>Summary of Operations</b>		
11	Operation	Record the date and time that the offloading / transhipment operation start and the date and time that the operation is completed.
12	Observed	Record the start and end dates and times that the offloading or transhipment are directly monitored.  Where the operations are not continuously monitored these dates and times must be recorded for each monitoring period.
13	Interruption times	Record in hours the total time that operations were interrupted for any reason. Interruption time can include time lost to: Equipment failure, Pause for meals, Overnight break.  For example: 30 min interruption to replace hook scale 1 hr 30 min (1:30) interruption for meals Total interruption time 2 hours (2:00)  The time from the start to the end of operations minus the interruption time is equal to the actual offloading or transhipment time where fish products are being moved.

## Port State measures

### Procedures for the implementation of the Indian ocean Tuna Commission

14	Percentage offloading monitored	<p>Record the percentage of the actual operation time that was monitored. This is equal to the total time of the operations monitored by the inspectors divided by the total offloading or transshipment time.</p> <p><i>For example;</i></p> <p><i>Total time of operations monitored; 8 hours and 20 minutes (08:20)</i></p> <p><i>Total operational time (excluding interruption time) 12 hours and 40 min</i></p> <p><i>Percentage of operation monitored is; 08:20 / 12:40</i></p> <p><i>Equals 65.79 percent</i></p>
	Destination Details	<p>Record the total quantities offloaded and / or transhipped.</p> <p>Note a proportion of the catch may be transhipped and another part of the catch offloaded ashore.</p>
15	Onshore / Total quantity	Record in free text the factory name or facility ashore that is receiving the fish together with the total weight of the product that is offloaded to that facility.
16	Carrier vessel / Total quantity	Record in free text the name of the carrier vessel receiving the fish and the total weight of the products transhipped to the carrier vessel.
	Summary of products offloaded	<p>Summary of the combined species, number per species and total weight per species for the entire offloading or transshipment. These will be a summary of all the data collected on the <b>OFFLOADING MONITORING FORM B</b></p>
17	Species	<p>Record the ASFIS 3-alpha codes for each species.</p> <p><i>For example; YFT</i></p>
18	Product	<p>Record the relevant product code. Note that there may be more than one produce for a single species.</p> <p><i>For example; Swordfish (SWO) corresponding products may include;</i></p> <ul style="list-style-type: none"> <li>→ <i>WHO for whole fish</i></li> <li>→ <i>TAL Dressed carcass with head and fins off and caudal peduncle present.</i></li> </ul>
19	Number of fish	Record the total number of units recorded for each species



20	Average weight of fish	<p>Record the average weight for each species / product unit. Various methods may be used to calculate an average unit weight.</p> <ul style="list-style-type: none"> <li>→ The most accurate will be to take random samples and independently weigh these.</li> <li>→ A single hoist with a number of units can be weighed and divided by the number of units.</li> <li>→ The declared catch number and weight can be used to calculate an average weight.</li> </ul> <p><i>For example;</i>  <i>Total weigh of SWO to be offloaded is 8.5-tons.</i>  <i>Number of units listed 145.</i>  <i>Average weight is 8500 divided by 145</i>  <i>Equals 58.6 kg</i></p>
21	Total weight of fish	<p>Record the total weight of product per species offloaded or transhipped.</p> <p>The average unit weights multiplied by the total number of units monitored is used to obtain the total weight.</p>



Add rows										

## Port State measures

### Procedures for the implementation of the Indian ocean Tuna Commission

Field  
No.

## OFFLOADING MONITORING FORM B - Field Descriptions

The offloading monitoring FORM B is designed to record detailed information for the time that inspectors are monitoring landing or transhipment operations. It aims to capture accurate information for each hoist of fish offloaded from the vessel. These are "real time" data collection forms and additional pages are added as required. The headers (Fields 1 and 2) must be completed for each page.

1	Inspection report No	The Inspection Report No. must correspond to the <b>OFFLOADING MONITORING FORM A.</b>
2	Form No. _____ of _____	Multiple forms will be required to monitor the entire offloading operation and each form should be numbered and reflect the total number of pages completed.  <i>For example: 3 of 12 would indicate that this is the third page out of a total of 12 pages used to monitor the offloading process.</i>  Should there be a break in the sequence of pages when reviewing the data at a later stage then authorities would be aware of the missing pages
3	Period Start:	Record the day / month year and time for the start of each monitoring period.  Note these may correspond to scheduled interruptions in the offloading operations for overnight or meal breaks. <i>Format: dd/mm/yyyy hh:mm.</i>
4	Period End:	Record the day / month year and time that the monitoring observation stopped. <i>Format: dd/mm/yyyy hh:mm.</i>
5	Interrupted:	Tick the box to record YES if interruptions occurred or NO if none occurred.  The interruptions recorded reflect those that may occur during the monitoring period recorded in fields 3 and 4.  An interruption in the offloading process may be for equipment failure or routine breaks for meals. Some offloading operations may take place over several days with overnight breaks in the process.
6	No. of Interruptions	If there were interruptions in the monitoring process record the number of interruptions
7	Total Time Interruptions	Record in hours the total interruption times.

8	Type of operation:	Tick the relevant box if the vessel is landing ashore or transshipping or if both.
	Number of fish per string / hoist	In this section the details of each hoist of fish off the vessel are recorded.
9	Hoist No.	Start number sequence from the first hoist observed for each monitoring period corresponding to the start and end times for the monitoring period recorded in (3) (4) above.
10	Spp.	For each hoist record the species codes for the species of fish in the hoist. Note it may not be possible to always record specific species and aggregations of mixed species may be recorded. For example; <i>"mixed" <b>SJK, ALB</b>" (for a mix of small skipjack tuna and longfin tuna in a single hoist)</i> <i>"mixed" <b>LEK, OIL</b>" (for mixture of escolar and rough skin oilfish)</i>
11	Prod	Record the product codes for each of the species
12	Total No.	Estimate the total number of units in the hoist.
13	Hook Scale Weight	When a "Hook Scale" is attached to the crane hook then record the total weight of the hoist

## APPENDIX XII:

# Request for additional information [following a port inspection]



### REQUEST FOR ADDITIONAL INFORMATION [FOLLOWING A PORT INSPECTION]

(IOTC Resolution 16/11 – Paragraph 7 and 9)

Date: \_\_\_/\_\_\_/\_\_\_\_\_

FROM:

Port State	
Competent authority	

TO:

Recipient name	
----------------	--

Possible recipients of the RAI: Flag State, Coastal State, Port State, Agent, Beneficial owner, Owner, Operator, Master, Fishing Master, Secretariat of RFMO, CPCs

INFORMATION ON VESSEL					
AREP Received	___/___/_____	Port of call		Date of entry into port	___/___/_____
Purpose of call:	<input type="checkbox"/> Landing <input type="checkbox"/> Transhipping <input type="checkbox"/> Packaging <input type="checkbox"/> Processing <input type="checkbox"/> Refueling <input type="checkbox"/> Resupplying <input type="checkbox"/> Maintenance <input type="checkbox"/> Drydocking <input type="checkbox"/> Force majeure				
Name of vessel		Flag of vessel		IRCS	
RFMO Number		Certificate of registry ID			

**REQUEST FOR ADDITIONAL INFORMATION/CONFIRMATION OF COMPLIANCE WITH RFMO REQUIREMENTS**

Confirmation is requested that all fish on board the vessel was taken in accordance with all applicable requirements of a relevant regional fisheries management organisation (RFMO): \_\_\_\_\_, including the IOTC. To confirm that the fish on board was taken in accordance with applicable requirements of the RFMO, all information/documents indicated below must be received within \_\_\_\_\_ working days of the issuance of this request. If confirmation is not received within indicated working days, the vessel will be denied use of port for landing, transhipping, packaging, processing, refuelling, resupplying, maintenance and drydocking in accordance with paragraph 9.1 (d) of IOTC Resolution 16/11.

- Flag State authorisation to fish
  Flag State authorisation to tranship  
 Fishing logbook: from \_\_\_\_\_ to \_\_\_\_\_
  Certificate of registry of the fishing vessel  
 RFMO transhipment declarations (from transhipment operation with donors vessels)  
 VMS record from \_\_\_/\_\_\_/\_\_\_\_\_ to \_\_\_/\_\_\_/\_\_\_\_\_  
 Others information/document: (specify): \_\_\_\_\_

Name of officer	Date and signature	Official stamp

**Transmitted to:**

- |   |  |
|---|--|
| <input type="checkbox"/> Customs: _____             | <input type="checkbox"/> Flag State: _____       |
| <input type="checkbox"/> Immigration: _____         | <input type="checkbox"/> Coastal State(s): _____ |
| <input type="checkbox"/> Port Authority: _____      | <input type="checkbox"/> RFMO(s): _____          |
| <input type="checkbox"/> Police/Navy/Defense: _____ | <input type="checkbox"/> Others (specify) _____  |

## APPENDIX XIII:

### Codes for countries, fishing gears, fishing vessels and IOTC species

#### Countries/territories codes (ISO-3166 3-alpha Country Code)

Nom de pays	Code ISO ALPHA-3	Nom de pays	Code ISO ALPHA-3
Australia	AUS	Madagascar	MDG
Belize	BLZ	Malaysia	MYS
China	CHN	Maldives	MDV
Comoros	COM	Mauritius	MUS
Eritrea	ERI	Mozambique	MOZ
European Union		Oman	OMN
France	FRA	Pakistan	PAK
Italia	ITA	Philippines	PHL
Portugal	PRT	Senegal	SEN
Spain	ESP	Seychelles	SYC
France (Territories)	FRA	South Africa	ZAF
India	IND	Sri Lanka	LKA
Indonesia	IDN	Sudan	SDN
Iran, Islamic Republic of	IRN	Tanzania, United Republic of	TZA
Japan	JPN	Thailand	THA
Kenya	KEN	United Kingdom	GBR
Korea, Republic of	KOR		



## Gear codes

Gear Code	Gear Type (EN)	Gear Code	Gear Type (EN)
BB	Pole and lines	LLHA	Longline and hand line
BBLI	Pole and Line, Hand Line, Troll line	LLLI	Longline and line
BBTR	Pole and Line, Troll line	LLPS	Drifting longline and purse seine and trap
FLL	Fresh Longline	LLTR	Longline and Troll line
GILL	Gill nets	LLTW	Longline and Trawl
HABB	Hand line and pole and line	PS	Purse seines
HAND	Hand line	PSS	Coastal purse seine
HOOK	Pole and Line, Hand Line, Longline, Troll line	SJIG	Squid Jigger
LINE	Line	SUPP	Supply Vessel Purse Seiners
LISJ	Line and squid jigging	TRAP	Traps
LL	Drifting longline	TRAW	Bottom and/or midwater trawls
LLBH	Pole and Line, Hand Line, Longline	TROL	Troll line
LLF	Set longline	UNCL	Unknown
LLGI	Longline and Gill nets		

## Vessel codes

Vessel Code	Vessel Type (EN)	Vessel Code	Vessel Type (EN)
BB	Pole and Line vessels	MU	Multipurpose
CF	Cargo Freezer	PS	Purse seiners
GI	Gill Netters	RT	Research-Training
LB	Longliners-Pole and Line vessels	SP	Supply vessel (purse seiners)
LC	Longliners and Carrier vessels	TW	Trawlers
LI	Line vessels	UN	Unknown
LL	Longliners		

## Port State measures

Procedures for the implementation of the Indian ocean Tuna Commission

### IOTC species codes

The table below shows the official alphanumeric codes (also called “3-alpha”) for the species under the mandate of the IOTC. The English and Scientific names are taken from the FAO taxonomy.

Code	English Name	Scientific Name
ALB	Albacore tuna	<i>Thunnus alalunga</i>
BET	Bigeye tuna	<i>Thunnus obesus</i>
BFT	Bluefin tuna	<i>Thunnus thynnus thynnus</i>
BIL	Marlins, sailfishes, spear fish	<i>Xiphoidei NEI*</i>
BIP	Indo-Pacific Bonito	<i>Sarda orientalis</i>
BLM	Black Marlin	<i>Makaira indica</i>
BLT	Bullet tuna	<i>Auxis rochei</i>
BLZ	Indo-Pacific Blue Marlin	<i>Makaira mazara</i>
COM	Narrow barred Spanish Mackerel	<i>Scomberomorus commersoni</i>
DOT	Dogtooth tuna	<i>Gymnosarda unicolor</i>
FRI	Frigate tuna	<i>Auxis thazard</i>
FRZ	Frigate and Bullet tunas	<i>Auxis spp.</i>
GUT	Indo-Pacific king mackerel	<i>Scomberomorus guttatus</i>
KAW	Kawakawa	<i>Euthynnus affinis</i>
KGX	Seerfishes NEI*	<i>Scomberini NEI*</i>
LOT	Longtail tuna	<i>Thunnus tonggol</i>
MAR	Marlines NEI*	
MLS	Striped Marlin	<i>Tetrapturus audax</i>
OBL	Billfishes, unclassified	
OTH	Others NEI*	<i>Scombridae and Xiphoidei</i>
RSK	Requiem sharks	<i>Carcharinidae</i>
SBF	Southern Bluefin tuna	<i>Thunnus maccoyii</i>
SFA	Indo-Pacific Sailfish	<i>Istiophorus platypterus</i>
SHK	Shark	
SKJ	Skipjack	<i>Katsuwonus pelamis</i>
SSP	Short-billed spearfish	<i>Tetrapterus angustirostris</i>
STS	Streaked seerfish	<i>Scomberomorus lineolatus</i>
SWO	Swordfish	<i>Xiphias gladius</i>
TUN	Tunas and Bonitos NEI*	<i>Thunnini and Sardini NEI*</i>
WAH	Wahoo	<i>Acanthocybium solandri</i>
YFT	Yellowfin tuna	<i>Thunnus albacares</i>

\*NEI: not elsewhere included



## Port State measures

Procedures for the implementation of the *Indian ocean Tuna Commission*



© IOTC



# Procedures for the implementation of the Indian Ocean Tuna Commission Port State measures



## Food and Agriculture Organization of the United Nations

Viale delle Terme di Caracalla  
00153 Rome, Italy

Tel: +39 06 57051  
E-mail: [FAO-HQ@fao.org](mailto:FAO-HQ@fao.org)

[www.fao.org](http://www.fao.org)

## Indian Ocean Tuna Commission

Le Chantier Mall  
PO Box 1011, Victoria, Seychelles

Tel: + 248 422 54 94  
E-mail: [iotc-secretariat@fao.org](mailto:iotc-secretariat@fao.org)

[www.iotc.org](http://www.iotc.org)



Co funded by IOTC, the European Union and the SWIOFish2 project of the World Bank.

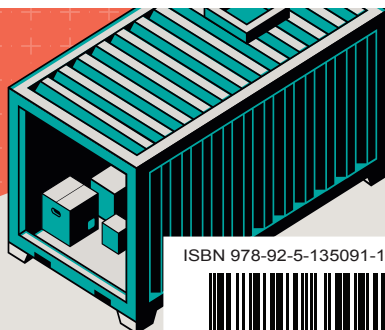

ISBN 978-92-5-135091-1



9 789251 350911

CB7113EN/1/11.21